



SARA-R4 series

Size-optimized LTE Cat M1 / NB1 / GPRS modules

AT commands manual

Abstract

Description of standard and proprietary AT commands used with u-blox cellular modules.

| Document information | |
|-------------------------------|--|
| Title | SARA-R4 series |
| Subtitle | Size-optimized LTE Cat M1 / NB1 / GPRS modules |
| Document type | AT commands manual |
| Document number | UBX-17003787 |
| Revision and date | R22 28-Jun-2021 |
| Disclosure restriction | C1-Public |

u-blox reserves all rights to this document and the information contained herein. Products, names, logos and designs described herein may in whole or in part be subject to intellectual property rights. Reproduction, use, modification or disclosure to third parties of this document or any part thereof without the express permission of u-blox is strictly prohibited.

The information contained herein is provided “as is” and u-blox assumes no liability for the use of the information. No warranty, either express or implied, is given, including but not limited, with respect to the accuracy, correctness, reliability and fitness for a particular purpose of the information. This document may be revised by u-blox at any time. For most recent documents, visit www.u-blox.com.

Copyright © 2018, u-blox AG

u-blox is a registered trademark of u-blox Holding AG in the EU and other countries.

Preface

Applicable products

This document applies to the following products:

| Name | Type number | Modem version | Application version | PCN reference |
|-------------------|---------------------|------------------|---------------------|---------------|
| SARA-R404M | SARA-R404M-00B-00 | K0.0.00.00.07.06 | N.A. | UBX-17047084 |
| | SARA-R404M-00B-01 | K0.0.00.00.07.08 | N.A. | UBX-18053670 |
| SARA-R410M | SARA-R410M-01B-00 | L0.0.00.00.02.03 | N.A. | UBX-18059854 |
| | SARA-R410M-02B-00 | L0.0.00.00.05.06 | A02.01 | UBX-18070443 |
| | SARA-R410M-02B-01 | L0.0.00.00.05.08 | 02.04 | UBX-19041392 |
| | SARA-R410M-02B-02 | L0.0.00.00.05.11 | A.02.16 | UBX-20033274 |
| | SARA-R410M-02B-03 | L0.0.00.00.05.12 | A.02.19 | UBX-20058104 |
| | SARA-R410M-52B-00 | L0.0.00.00.06.05 | A02.06 | UBX-18045915 |
| | SARA-R410M-52B-01 | L0.0.00.00.06.08 | A02.11 | UBX-19024506 |
| | SARA-R410M-52B-02 | L0.0.00.00.06.11 | A.02.16 | UBX-20033274 |
| | SARA-R410M-63B-00 | L0.08.12 | A.01.11 | UBX-20006293 |
| | SARA-R410M-63B-01 | L0.08.12 | A.01.12 | UBX-20053055 |
| | SARA-R410M-73B-00 | L0.08.12 | A.01.11 | UBX-20006294 |
| | SARA-R410M-73B-01 | L0.08.12 | A.01.12 | UBX-20049254 |
| | SARA-R410M-83B-00 | L0.08.12 | A.01.11 | UBX-20027231 |
| SARA-R410M-83B-01 | L0.08.12 | A.01.12 | UBX-20049255 | |
| SARA-R412M | SARA-R412M-02B-00 | M0.09.00 | A.02.11 | UBX-19004091 |
| | SARA-R412M-02B-01 | M0.10.00 | A.02.14 | UBX-19016568 |
| | SARA-R412M-02B-02 | M0.11.01 | A.02.17 | UBX-20031249 |
| | SARA-R412M-02B-03 | M0.12.00 | A.02.19 | UBX-20058105 |
| SARA-R422 | SARA-R422-00B-00 | 00.12 | A00.00 | UBX-21016086 |
| SARA-R422S | SARA-R422S-00B-00 | 00.12 | A00.00 | UBX-21016086 |
| SARA-R422M8S | SARA-R422M8S-00B-00 | 00.12 | A00.00 | UBX-21016086 |
| SARA-N410 | SARA-N410-02B-00 | L0.0.00.00.07.07 | A02.09 | UBX-18057459 |

How to use this manual

The u-blox Cellular Modules AT Commands Manual provides the necessary information to successfully design in and configure the applicable u-blox cellular modules.

This manual has a modular structure. It is not necessary to read it from the beginning to the end.

The following symbols are used to highlight important information within the manual:



An index finger points out key information pertaining to module integration and performance.



A warning symbol indicates actions that could negatively impact or damage the module.

Summary table

The summary table on the top of each command section is a quick reference for the user.

| command_name | | | | | | |
|-------------------|---------------------------------------|---------------------|-----------------------|-----------------------|----------------------|------------------------|
| Modules | TOBY-L2 MPCI-L2 | | | | | |
| | LISA-U110 LISA-U120 LISA-U130 LISA-U2 | | | | | |
| | LEON-G1 SARA-G3 | | | | | |
| Attributes | Syntax | PIN required | Settings saved | Can be aborted | Response time | Error reference |
| | full | No | No | No | - | - |

It is composed of two sections:

- **Modules:** lists all the modules that support the command. The modules are grouped in rows by cellular standard (i.e. L for LTE high data rate (Cat 3 and above), R for LTE low data rate (Cat 1 and below), U for UMTS/HSPA, G for GSM/GPRS, N for NB-IoT (LTE Cat NB1 / LTE Cat NB2)). In each row the modules

are grouped by: form factor (i.e. SARA, LISA), platform technology (e.g. SARA-G), platform generation (e.g. SARA-G3), product name (e.g. SARA-G350) and ordering code (e.g. SARA-G350-00S). In example: if 'LISA-U2' is reported, the command applies to all the modules having LISA form factor, second chipset version provided with any release of firmware.

- **Attributes**

- o **Syntax**

- **full:** the command syntax is fully compatible among all the products listed in the "Modules" section
- **partial:** the products support different syntaxes (usually backward compatible with respect to previous cellular standards)

- o **PIN required**

- **Yes:** it is necessary to insert the PIN before the set and/or read command execution
- **No:** the PIN insertion is not needed to execute the command

- o **Settings saved**

- **Profile:** the command setting can be saved in a personal profile as specified in [Chapter 1.4](#)
- **NVM:** the command setting is saved in the non-volatile memory as specified in [Chapter 1.4](#)
- **<command_name>:** the parameter values set with the command are volatile, but the whole profile can be stored in NVM with <command_name> AT command.
- **OP:** the command setting can be overwritten by the Mobile Network Operator (MNO) profile set with the +UMNOPROF or +UMNOCONF AT commands (if supported)
- **No:** the current command setting is volatile and cannot be saved

- o **Can be aborted**

- **Yes:** the command execution can be aborted if a character is sent to the DCE during the command execution
- **No:** the command cannot be aborted during the command execution

- o **Response time:** estimated maximum time to get the final result code for the AT command execution. More precisely, the command response time measures the time from the complete acquisition of the command line to the issuing of the command result code. This kind of response time is generally lower than the time measured by the application on the DTE, because the issuing of the command on the DTE is influenced by the AT interface characteristics (e.g. the synchronous/asynchronous transfer type, the selected baudrate, etc.), by power saving and flow control, which introduce a variable latency in the command acquisition by the DCE.

For example, the maximum expected response time shall be extended if the communication with the module is carried out on a MUX virtual port, because in this case the command line and the result code are transferred via a specific protocol running on the physical port, that might introduce additional communication delay due to framing and retransmissions.

Similarly, the maximum expected response time of AT commands accessing the SIM shall be extended if the module is using a remote SIM card via SAP instead of the local SIM card.

If the response time for a command is left blank (actually "-"), it is an "immediate" response. It means that the command is executed without asynchronous requests to the protocol stack or the internal applications, which usually require time to be answered: the command execution is synchronous (implying that no long blocking processing is done) and lasts a negligible time (the command response is issued by the module in typically less than 10 ms, and in any case less than 1 s).

The response time shall be extended if the issued AT command triggers a service that cannot be served immediately due to concurrent access to the same service or resource via AT commands issued on a different communication port or from internal applications; typical examples are registration commands and SIM access, that can be also autonomously triggered by the module (e.g. auto-COPS) and can therefore postpone the execution of the AT commands issued by the user.

- o **Error reference:** reference to the error result codes listed in the [Appendix A](#)

The attributes listed in the summary table apply by default to all u-blox modules supporting the specific AT command. If a u-blox module or module series does not comply to the default behavior, the exception is highlighted in [Chapter 1.4](#) for the saving of settings, in [Chapter 1.3.4](#) for the abortability, and in a product specific note in the AT command description for the PIN check.

u-blox technical documentation

As part of our commitment to customer support, u-blox maintains an extensive volume of technical documentation for our products. In addition to our product-specific technical data sheets, the following manuals are available to assist u-blox customers in product design and development.

AT Commands Manual: This document provides the description of the AT commands supported by u-blox cellular modules.

System Integration Manual: This document describes u-blox cellular modules from the hardware and the software point of view. It provides hardware design guidelines for the optimal integration of the cellular module in the application device and it provides information on how to set up production and final product tests on application devices integrating the cellular module.

Application Notes: These documents provide guidelines and information on specific u-blox cellular module hardware or software topics.

- For some guidelines when developing applications for LTE Cat M1 technologies, see the SARA-R4 series application development guide [16] or the SARA-R5 series application development guide [12].
- For some guidelines when developing applications for NB-IoT technologies, see the SARA-N3 series application development guide [32] or the NB-IoT application development guide [29].
- For more examples of typical scenarios when developing application for LTE Cat 4, LTE Cat 1, UMTS/HSPA and GSM/GPRS technologies, see the AT commands examples application note [34].

See [Related documents](#) for application notes related to your cellular module.

Questions

If you have any questions about u-blox Cellular Hardware Integration, please:

- Read this manual carefully
- Contact our information service on our homepage www.u-blox.com
- Read the questions and answers on our FAQ database

Technical Support

Worldwide Web

Our website (www.u-blox.com) is a rich pool of information. Product information, technical documents and helpful FAQ can be accessed 24h a day.

By email

If you have technical problems or cannot find the required information in the provided documents, contact the nearest of the Technical Support offices by email. Use our service pool email addresses rather than any personal email address of our staff. This makes sure that your request is processed as soon as possible. You will find the contact details at the end of the document.

Helpful Information when Contacting Technical Support

When contacting Technical Support please have the following information ready:

- Module type (e.g. SARA-G350-00S-00) and firmware version (e.g. 08.49)
- Module configuration
- Clear description of your question or the problem
- A short description of the application
- Your complete contact details

Contents

| | | |
|----------|---|-----------|
| 1 | AT command settings..... | 12 |
| 1.1 | Definitions..... | 12 |
| 1.2 | Operational mode of the AT interface..... | 12 |
| 1.3 | Command description..... | 13 |
| 1.4 | Storing of AT commands setting..... | 17 |
| 1.5 | S-parameters..... | 17 |
| 1.6 | +UDCONF AT command..... | 17 |
| 2 | General operation..... | 19 |
| 2.1 | Start up and initialization..... | 19 |
| 2.2 | AT commands types..... | 20 |
| 3 | IPC - Inter Processor Communication..... | 22 |
| 3.1 | Multiplexing mode +CMUX..... | 22 |
| 4 | General..... | 24 |
| 4.1 | Manufacturer identification +CGMI..... | 24 |
| 4.2 | Manufacturer identification +GMI..... | 24 |
| 4.3 | Model identification +CGMM..... | 24 |
| 4.4 | Model identification +GMM..... | 25 |
| 4.5 | Firmware version identification +CGMR..... | 25 |
| 4.6 | Firmware version identification +GMR..... | 26 |
| 4.7 | Request product serial number identification +CGSN..... | 26 |
| 4.8 | IMEI identification +GSN..... | 28 |
| 4.9 | Identification information I..... | 28 |
| 4.10 | TE character set configuration +CSCS..... | 29 |
| 4.11 | International mobile subscriber identification +CIMI..... | 30 |
| 4.12 | Card identification +CCID..... | 30 |
| 4.13 | Request complete capabilities list +GCAP..... | 31 |
| 4.14 | Repeat last command A/..... | 31 |
| 5 | Mobile equipment control and status..... | 32 |
| 5.1 | Phone activity status +CPAS..... | 32 |
| 5.2 | Module switch off +CPWROFF..... | 32 |
| 5.3 | Set module functionality +CFUN..... | 33 |
| 5.4 | Indicator control +CIND..... | 34 |
| 5.5 | Configuration of indicator control +UCIND..... | 36 |
| 5.6 | Mobile termination event reporting +CMER..... | 37 |
| 5.7 | Clock +CCLK..... | 39 |
| 5.8 | Set greeting text +CSGT..... | 39 |
| 5.9 | Automatic time zone update +CTZU..... | 40 |
| 5.10 | Time zone reporting +CTZR..... | 41 |
| 5.11 | Report mobile termination error +CMEE..... | 42 |
| 6 | Call control..... | 43 |
| 6.1 | Dial command D..... | 43 |
| 6.2 | Call answer A..... | 44 |
| 6.3 | Hook control H..... | 44 |
| 6.4 | Voice hangup control +CVHU..... | 44 |
| 7 | Network service..... | 46 |
| 7.1 | Network parameters definition..... | 46 |
| 7.2 | Subscriber number +CNUM..... | 48 |
| 7.3 | Signal quality +CSQ..... | 49 |
| 7.4 | Extended signal quality +CESQ..... | 50 |

| | | |
|----------|--|-----------|
| 7.5 | Operator selection +COPS..... | 51 |
| 7.6 | Radio Access Technology (RAT) selection +URAT..... | 53 |
| 7.7 | CloT Configuration - iRAT timer +URATSCAN..... | 55 |
| 7.8 | Full cell scan +UCFSCAN..... | 56 |
| 7.9 | MAC QoS inactivity timer(s) +UMACQOSTMR..... | 59 |
| 7.10 | Preferred PLMN list selection +CPLS..... | 59 |
| 7.11 | Network registration status +CREG..... | 60 |
| 7.12 | Preferred operator list +CPOL..... | 63 |
| 7.13 | Read operator names +COPN..... | 64 |
| 7.14 | Steering of Roaming configuration +UDCONF=20..... | 65 |
| 7.15 | Network selection control +PACSP..... | 66 |
| 7.16 | Integrity check on test networks configuration +UDCONF=81..... | 67 |
| 7.17 | Channel and network environment description +UCGED..... | 67 |
| 7.18 | Smart jamming detection +UJAD..... | 71 |
| 7.19 | Edit Verizon wireless APN table +VZWAPNE..... | 72 |
| 7.20 | Read RSRP values +VZWRSRP..... | 73 |
| 7.21 | Read RSRQ values +VZWRSRQ..... | 74 |
| 7.22 | Signalling connection status +CSCON..... | 75 |
| 7.23 | Radio Policy Manager (RPM) activation +URPM..... | 76 |
| 7.24 | eDRX setting +CEDRXS..... | 77 |
| 7.25 | eDRX read dynamic parameters +CEDRXRDP..... | 79 |
| 7.26 | Set MNO profile +UMNOPROF..... | 80 |
| 7.27 | Band selection bitmask +UBANDMASK..... | 83 |
| 7.28 | Device service domain configuration +USVCDOMAIN..... | 85 |
| 7.29 | CloT capabilities configuration +UCFGCIOT..... | 86 |
| 7.30 | CloT optimization configuration +CCIOTOPT..... | 87 |
| 7.31 | NB-IoT band scan tuning +UDCONF=77..... | 88 |
| 7.32 | Retrieve coverage enhancement mode information +CEINFO..... | 89 |
| 8 | Device lock..... | 91 |
| 8.1 | Enter PIN +CPIN..... | 91 |
| 8.2 | Facility lock +CLCK..... | 92 |
| 8.3 | Change password +CPWD..... | 93 |
| 9 | Short Messages Service..... | 95 |
| 9.1 | Introduction..... | 95 |
| 9.2 | Select message service +CSMS..... | 96 |
| 9.3 | Preferred message storage +CPMS..... | 97 |
| 9.4 | Preferred message format +CMGF..... | 98 |
| 9.5 | Save settings +CSAS..... | 99 |
| 9.6 | Restore settings +CRES..... | 99 |
| 9.7 | Show text mode parameters +CSDH..... | 100 |
| 9.8 | New message indication +CNMI..... | 100 |
| 9.9 | Select service for MO SMS messages +CGSMS..... | 104 |
| 9.10 | Read message +CMGR..... | 104 |
| 9.11 | New message acknowledgement to MT +CNMA..... | 107 |
| 9.12 | List message +CMGL..... | 108 |
| 9.13 | Send message +CMGS..... | 110 |
| 9.14 | Write message to memory +CMGW..... | 111 |
| 9.15 | Send message from storage +CMSS..... | 112 |
| 9.16 | Set text mode parameters +CSMP..... | 113 |
| 9.17 | Delete message +CMGD..... | 114 |
| 9.18 | Service center address +CSCA..... | 114 |
| 9.19 | Read concatenated message +UCMGR..... | 115 |
| 9.20 | List concatenated message +UCMGL..... | 118 |
| 9.21 | Send concatenated message +UCMGS..... | 120 |
| 9.22 | Write concatenated message to memory +UCMGW..... | 121 |
| 9.23 | More messages to send +CMMS..... | 122 |
| 9.24 | Peek message +UCMGP..... | 123 |
| 9.25 | Send SMS command +CMGC..... | 124 |
| 9.26 | Sending of originating data via the control plane +CSODCP..... | 125 |

| | | |
|-----------|---|------------|
| 9.27 | Terminating data reporting via control plane +CRTDCP..... | 126 |
| 10 | V24 control and V25ter..... | 128 |
| 10.1 | Introduction..... | 128 |
| 10.2 | Circuit 109 behavior &C..... | 128 |
| 10.3 | Circuit 108/2 and escape sequence behavior &D..... | 128 |
| 10.4 | DSR override &S..... | 130 |
| 10.5 | Flow control &K..... | 130 |
| 10.6 | DTE-DCE character framing +ICF..... | 131 |
| 10.7 | DTE-DCE local flow control +IFC..... | 132 |
| 10.8 | Set flow control \Q..... | 133 |
| 10.9 | UART data rate configuration +IPR..... | 133 |
| 10.10 | Return to on-line data state O..... | 134 |
| 10.11 | Escape character S2..... | 135 |
| 10.12 | Command line termination character S3..... | 136 |
| 10.13 | Response formatting character S4..... | 136 |
| 10.14 | Command line editing character S5..... | 137 |
| 10.15 | Pause before blind dialling S6..... | 137 |
| 10.16 | Connection completion timeout S7..... | 138 |
| 10.17 | Command dial modifier time S8..... | 138 |
| 10.18 | Automatic disconnect delay S10..... | 139 |
| 10.19 | Escape prompt delay (EPD) S12..... | 139 |
| 10.20 | Command echo E..... | 140 |
| 10.21 | Result code suppression Q..... | 140 |
| 10.22 | DCE response format V..... | 141 |
| 10.23 | Result code selection and call progress monitoring control X..... | 141 |
| 10.24 | Reset to default configuration Z..... | 142 |
| 10.25 | Set to factory defined configuration &F..... | 142 |
| 10.26 | Display current configuration &V..... | 143 |
| 11 | SIM management..... | 144 |
| 11.1 | Generic SIM access +CSIM..... | 144 |
| 11.2 | Restricted SIM access +CRSM..... | 144 |
| 11.3 | Read the SIM language +CLAN..... | 146 |
| 11.4 | Check for UICC card +UICC..... | 147 |
| 11.5 | UICC application discovery +CUAD..... | 147 |
| 11.6 | SIM states reporting +USIMSTAT..... | 148 |
| 12 | SIM toolkit..... | 150 |
| 12.1 | Introduction..... | 150 |
| 12.2 | Bearer Independent Protocol status indication +UBIP..... | 150 |
| 12.3 | Read the USAT profile +CUSATR..... | 151 |
| 12.4 | Write the USAT profile +CUSATW..... | 152 |
| 12.5 | Enable USAT terminal URCS +UCUSATA..... | 153 |
| 13 | Packet switched data services..... | 154 |
| 13.1 | PDP contexts and parameter definition..... | 154 |
| 13.2 | PPP LCP handshake behaviour..... | 155 |
| 13.3 | Printing IP address format +CGPIAF..... | 156 |
| 13.4 | PDP context definition +CGDCONT..... | 157 |
| 13.5 | Packet switched data configuration +UPSD..... | 161 |
| 13.6 | GPRS attach or detach +CGATT..... | 163 |
| 13.7 | PDP context activate or deactivate +CGACT..... | 164 |
| 13.8 | Enter PPP state/GPRS dial-up D*..... | 166 |
| 13.9 | Show PDP address +CGPADDR..... | 167 |
| 13.10 | Packet switched event reporting +CGEREP..... | 168 |
| 13.11 | GPRS network registration status +CGREG..... | 170 |
| 13.12 | Manual deactivation of a PDP context H..... | 172 |
| 13.13 | UE modes of operation for EPS +CEMODE..... | 172 |
| 13.14 | EPS network registration status +CEREG..... | 173 |
| 13.15 | Delete non-active PDP contexts +CGDEL..... | 176 |

| | | |
|-----------|--|------------|
| 13.16 | Configure the authentication parameters of a PDP/EPS bearer +UAUTHREQ..... | 177 |
| 13.17 | PDP context read dynamic parameters +CGCONTRDP..... | 178 |
| 13.18 | Initial PDP context activation +CIPCA..... | 180 |
| 13.19 | PDP IP configuration when roaming +UDCONF=75..... | 181 |
| 13.20 | Disable data when roaming +UDCONF=76..... | 182 |
| 14 | System features..... | 183 |
| 14.1 | Firmware installation +UFWINSTALL..... | 183 |
| 14.2 | Firmware update Over AT (FOAT) +UFWUPD..... | 185 |
| 14.3 | Antenna detection +UANTR..... | 186 |
| 14.4 | Production test +UTEST..... | 187 |
| 14.5 | MSPR profile handling configuration +UDCONF=40..... | 199 |
| 14.6 | UART baud rate and flow control NVM management +UUARTCONF..... | 200 |
| 14.7 | Serial interfaces configuration selection +USIO..... | 201 |
| 14.8 | Internal temperature monitor +UTEMP..... | 203 |
| 14.9 | Restore factory configuration +UFACTORY..... | 204 |
| 14.10 | Backup and restore the file system +UBKUPDATA..... | 204 |
| 14.11 | Cancel FOTA download +UFOTA..... | 206 |
| 14.12 | Sets FOTA status URCs +UFOTASTAT..... | 206 |
| 14.13 | uFOTA configuration +UFOTACONF..... | 209 |
| 14.14 | Last gasp configuration +ULGASP..... | 210 |
| 14.15 | RING line configuration +URINGCFG..... | 212 |
| 15 | Power management..... | 213 |
| 15.1 | Power saving control (Power SaVing) +UPSV..... | 213 |
| 15.2 | Power Saving Mode Setting +CPSMS..... | 214 |
| 15.3 | Power Saving Mode assigned values +UCPSMS..... | 217 |
| 15.4 | Power Saving Mode versions configuration +UPSMVER..... | 218 |
| 15.5 | Power Saving Mode indication +UPSMR..... | 220 |
| 16 | GPIO..... | 222 |
| 16.1 | Introduction..... | 222 |
| 16.2 | GPIO select configuration command +UGPIOC..... | 227 |
| 16.3 | GPIO read command +UGPIOR..... | 229 |
| 16.4 | GPIO set command +UGPIOW..... | 230 |
| 17 | File System..... | 231 |
| 17.1 | File tags..... | 231 |
| 17.2 | Download file +UDWNFILE..... | 233 |
| 17.3 | List files information +ULSTFILE..... | 234 |
| 17.4 | Read file +URDFILE..... | 235 |
| 17.5 | Partial read file +URDBLOCK..... | 236 |
| 17.6 | Delete file +UDELFILE..... | 237 |
| 17.7 | Partial download file +UDWNBLOCK..... | 237 |
| 17.8 | File system limits..... | 238 |
| 18 | DNS..... | 239 |
| 18.1 | Resolve name / IP number through DNS +UDNSRN..... | 239 |
| 18.2 | Dynamic DNS update +UDYNDNS..... | 240 |
| 19 | Internet protocol transport layer..... | 244 |
| 19.1 | Introduction..... | 244 |
| 19.2 | IPv4/IPv6 addressing..... | 244 |
| 19.3 | Create Socket +USOCR..... | 245 |
| 19.4 | SSL/TLS/DTLS mode configuration on TCP/UDP socket +USOSEC..... | 246 |
| 19.5 | Set socket option +USOSO..... | 247 |
| 19.6 | Get Socket Option +USOGO..... | 249 |
| 19.7 | Close Socket +USOCL..... | 250 |
| 19.8 | Get Socket Error +USOER..... | 251 |
| 19.9 | Connect Socket +USOCO..... | 251 |
| 19.10 | Write socket data +USOWR..... | 252 |
| 19.11 | SendTo command (UDP only) +USOST..... | 254 |

| | | |
|-----------|--|------------|
| 19.12 | Read Socket Data +USORD..... | 256 |
| 19.13 | Receive From command (UDP only) +USORF..... | 258 |
| 19.14 | Set Listening Socket +USOLI..... | 259 |
| 19.15 | HEX mode configuration +UDCONF=1..... | 260 |
| 19.16 | Set socket in Direct Link mode +USODL..... | 261 |
| 19.17 | UDP Direct Link Packet Size configuration +UDCONF=2..... | 263 |
| 19.18 | UDP Direct Link Sending timer configuration +UDCONF=3..... | 264 |
| 19.19 | Timer Trigger configuration for Direct Link +UDCONF=5..... | 264 |
| 19.20 | Data Length Trigger configuration for Direct Link +UDCONF=6..... | 265 |
| 19.21 | Character trigger configuration for Direct Link +UDCONF=7..... | 265 |
| 19.22 | Congestion timer configuration for Direct Link +UDCONF=8..... | 266 |
| 19.23 | Internal IP stack congestion configuration +UDCONF=18..... | 266 |
| 19.24 | Direct Link disconnect DSR line handling +UDCONF=10..... | 267 |
| 19.25 | Socket control +USOCTL..... | 268 |
| 19.26 | IP Change Notification +UIPCHGN..... | 269 |
| 19.27 | Configure Dormant Close Socket Behavior +USOCLCFG..... | 273 |
| 20 | Device and data security..... | 275 |
| 20.1 | Introduction..... | 275 |
| 20.2 | Device security..... | 275 |
| 20.3 | Data security..... | 282 |
| 21 | FTP..... | 310 |
| 21.1 | FTP service configuration +UFTP..... | 310 |
| 21.2 | FTP command +UFTPC..... | 313 |
| 21.3 | FTP error +UFTPER..... | 316 |
| 22 | HTTP..... | 318 |
| 22.1 | HTTP control +UHTTP..... | 318 |
| 22.2 | HTTP advanced control+UHTTPAC..... | 321 |
| 22.3 | HTTP command +UHTTPC..... | 323 |
| 22.4 | HTTP protocol error +UHTTPER..... | 325 |
| 23 | Ping..... | 327 |
| 23.1 | Ping command +UPING..... | 327 |
| 24 | Positioning..... | 329 |
| 24.1 | NMEA..... | 329 |
| 24.2 | AssistNow services..... | 329 |
| 24.3 | GNSS..... | 330 |
| 24.4 | CellLocate® and hybrid positioning..... | 344 |
| 25 | I²C..... | 353 |
| 25.1 | Introduction..... | 353 |
| 25.2 | I ² C open logical channel +UI2CO..... | 353 |
| 25.3 | I ² C write to peripheral +UI2CW..... | 354 |
| 25.4 | I ² C read from peripheral +UI2CR..... | 355 |
| 25.5 | I ² C read from peripheral register +UI2CREGR..... | 355 |
| 25.6 | I ² C close logical channel +UI2CC..... | 356 |
| 26 | Networking..... | 357 |
| 26.1 | Configure port filtering for embedded applications +UEMBPF..... | 357 |
| 27 | Constrained Application Protocol (CoAP)..... | 358 |
| 27.1 | Introduction..... | 358 |
| 27.2 | CoAP profile configuration +UCOAP..... | 358 |
| 27.3 | CoAP command +UCOAPC..... | 361 |
| 27.4 | CoAP error reporting +UCOAPER..... | 363 |
| 28 | MQTT..... | 364 |
| 28.1 | Introduction..... | 364 |
| 28.2 | MQTT profile configuration +UMQTT..... | 364 |

| | | |
|-----------|--|------------|
| 28.3 | MQTT will topic configuration +UMQTTWTOPIC..... | 369 |
| 28.4 | MQTT will message configuration +UMQTTWMSG..... | 370 |
| 28.5 | Save/Restore MQTT profile from NVM +UMQTTNV..... | 371 |
| 28.6 | MQTT command +UMQTTTC..... | 372 |
| 28.7 | MQTT error +UMQTTTER..... | 378 |
| 29 | MQTT-SN..... | 379 |
| 29.1 | Introduction..... | 379 |
| 29.2 | MQTT-SN profile configuration +UMQTTSN..... | 379 |
| 29.3 | Save/Restore MQTT-SN profile from NVM +UMQTTSNV..... | 382 |
| 29.4 | MQTT-SN command +UMQTTSC..... | 383 |
| 29.5 | MQTT-SN error +UMQTTSE..... | 386 |
| 30 | Lightweight M2M..... | 388 |
| 30.1 | LwM2M Objects management..... | 388 |
| 30.2 | LwM2M connectivity..... | 393 |
| A | Appendix: Error result codes..... | 409 |
| A.1 | Mobile termination error result codes +CME ERROR..... | 409 |
| A.2 | Message service error result codes +CMS ERROR..... | 415 |
| A.3 | Firmware install final result codes..... | 419 |
| A.4 | FOAT error result codes..... | 420 |
| A.5 | Dynamic DNS unsolicited indication codes..... | 420 |
| A.6 | Internal TCP/UDP/IP stack class error codes..... | 421 |
| A.7 | Internet suite error classes..... | 423 |
| A.8 | IP change notification error result codes..... | 433 |
| A.9 | Ping error result codes..... | 433 |
| B | Appendix: AT Commands List..... | 435 |
| B.1 | Parameters stored in profiles..... | 461 |
| B.2 | Parameters stored in non volatile memory..... | 462 |
| B.3 | Saving AT commands configuration..... | 466 |
| B.4 | Estimated command response time..... | 466 |
| B.5 | Multiple AT command interfaces..... | 467 |
| C | Mobile Network Operator profiles..... | 470 |
| C.1 | SARA-R4 Introduction..... | 470 |
| C.2 | SARA-R422 / SARA-R422M8S / SARA-R422S Americas MNO and conformance profiles table..... | 471 |
| C.3 | SARA-R422 / SARA-R422M8S / SARA-R422S EMEA MNO profiles table..... | 473 |
| C.4 | SARA-R410M-02B Americas MNO profile tables..... | 475 |
| C.5 | SARA-R410M-02B APAC MNO profiles table..... | 478 |
| C.6 | SARA-R410M-02B EMEA MNO profiles table..... | 480 |
| C.7 | SARA-R410M-52B Americas MNO profiles table..... | 482 |
| C.8 | SARA-R410M-63B / SARA-R410M-73B / SARA-R410M-83B Americas MNO profiles table..... | 484 |
| C.9 | SARA-R410M-63B / SARA-R410M-73B / SARA-R410M-83B APAC MNO profiles table..... | 486 |
| C.10 | SARA-R410M-83B EMEA MNO profile table..... | 488 |
| C.11 | SARA-R412M Americas MNO profiles table..... | 489 |
| C.12 | SARA-R412M EMEA profiles table..... | 492 |
| D | Appendix: UDP Direct Link workflow..... | 494 |
| D.1 | Data from the IP network to the external port..... | 494 |
| D.2 | Data from the external port to the IP network..... | 494 |
| E | Appendix: glossary..... | 496 |
| | Related documentation..... | 500 |
| | Revision history..... | 505 |
| | Contact..... | 510 |

1 AT command settings

u-blox cellular modules provide at least one physical serial interface that is compliant to V.24 [188]. When the module is powered on, it enters the command mode. For more details on command mode, see [Chapter 1.1](#).

For module and hyper terminal connection and settings see the corresponding evaluation kit user guide.

1.1 Definitions

In this document the following naming conventions are used:

- MT (Mobile Terminal) or DCE (Data Communications Equipment): u-blox cellular module
- TE (Terminal Equipment) or DTE (Data Terminal Equipment): terminal that issues the command to the module
- TA (Terminal Adaptor): the function, integrated in the MT, of supporting AT command interface according to the applicable standards
- ME (Mobile Equipment): equivalent to MT, it is used to refer to the device itself regardless of the inserted SIM card

The terms DCE and DTE are used in the serial interface context.



SARA-R4 / SARA-N4

u-blox cellular modules can implement more than one interface between the DTE and the DCE, either virtual interfaces (multiplexer channels) or physical interfaces (UART, USB, SPI, etc., when available). Each interface works as specified by the followings definitions. If not differently stated, all the subsequent descriptions are applicable to each interface. [Appendix B.5](#) describes the different behaviour among the interfaces in reference to the AT command interface.



See the corresponding module data sheet for the list of available AT command interfaces.



SARA-R4

Where supported, two UART AT interfaces can be used at the same time (it is not the default behaviour). See [+USIO](#) command description for details on how to set such behaviour.

According to the terminology used in the data sheet, UART is the main asynchronous serial interface, while AUX UART is the auxiliary asynchronous interface. For more details on supported serial interfaces and their characteristics, see the corresponding module data sheet.

The same naming will be used in the rest of the document (when not clearly specified, the description shall be considered applicable to both the interfaces).

1.2 Operational mode of the AT interface

The DCE/MT interface can operate in these modes:

- **Command mode:** the DCE waits for AT command instructions. The DCE interprets all the characters received as commands to execute. The DCE may send responses back to the DTE indicating the outcome of the command or further information without having received any commands by the DTE (e.g. unsolicited response code - URC). Any communication in the command mode (in both directions) is terminated by the command line termination character.
- **Data mode:** the DCE transfers data after having sent the "CONNECT" string; all the characters sent to the DCE are intended to be transmitted to the remote party. Any further characters received over the serial link are deemed to be from the remote party, and any characters sent are transmitted to the remote party. The DCE enters data mode immediately after it makes a Circuit Switched Data (CSD) or Packet Switched Data (PSD) connection (PPP or DUN connection).
- **Online command mode:** the DCE has a data connection established with a remote party, but treats signals from the DTE as command lines and sends back responses and unsolicited indications to the DTE.
- **Direct link mode:** intermediate state where the DCE transfers data transparently over a connected TCP/UDP socket (e.g. by means of [+USODL](#)), after reporting the "CONNECT" string.
- **SMS mode:** AT commands for writing or sending SMSs lead the AT interface into an intermediate state indicated by the ">" (greater-than sign) where SMS text/PDU can be entered (DCD signal shall be in ON state during this operation). <Ctrl-Z> indicates that the SMS editing is completed, while <ESC> indicates aborting of the edited SMS.
- **Raw mode:** special AT commands lead the AT interface into intermediate state where raw data is being exchanged (e.g. during file transfer).

- **AT commands over an IP connection:** the DCE is accepting a TCP connection on a specific TCP port. The DTE can connect via TCP protocol to the port and can send commands over this TCP connection. The DCE may send responses back to the DTE via the same TCP connection. The communication over IP connection is denoted by a set of two ports:
 - o AT command port;
 - o binary data port. The binary data port is used for the exchange of binary data between the DCE and DTE. For more details, on the configuration of the TCP ports see [+UIFCNF](#).

 SARA-R4 / SARA-N4
The AT commands over IP connection is not supported.

 SARA-R4 / SARA-N4
For more details on PSD connection, see the [+UPSD](#) and the [+CGACT](#) (where supported) AT commands description.

1.2.1 Switch from data mode to online command mode

When a data connection is established it is possible to switch from data mode to online command mode (OLCM) in the following ways:

- with the escape sequence: for more details, see the [S2](#) AT command description
- via a DTR transition: during data mode, the current DTR state is not important, but only its transition. Furthermore, only the DTR transition from ON to OFF is detected; it can be used to control the switch to OLCM, or to command mode (the data connection is released). For more details, see the [&D](#) AT command description

To switch back to data mode from OLCM the [O](#) AT command is used. For more details, see also the [&D](#) AT command.

When using the multiplexer and PPP combined, toggling the DTR line (of the physical serial interface where the multiplexer protocol is started) from ON to OFF state does not terminate the PPP session and return the device to the command mode. In this configuration, it is recommended that the host terminates the PPP session, which can be done by sending LCP_TERM REQ or deasserting the DTR virtual line (sending of specific MUX MSC command).

- SARA-R422 / SARA-R422M8S / SARA-R422S - For more details, see the SARA-R42 application development guide [\[17\]](#).
- SARA-R410M/SARA-R412M/SARA-N4 - For more details, see the SARA-R4 series application development guide [\[16\]](#).

 SARA-R4 / SARA-N4
The DTR transition is ignored if the DCE is in online command mode during a PPP call. To tear down the PPP call, switch back to data mode by means of the [O](#) AT command and then toggle the DTR from ON to OFF state.

1.3 Command description

The AT commands configure and enable the cellular module functionalities according to 3GPP normative and u-blox specifications. The AT commands are issued to the module via a hyper terminal through a command line and are described in the following sections. A general description of each command is provided including the functionalities, the correct syntax to be provided by the TE/DTE, the allowed responses and an example. The command description defines each named parameter with its type, its range (valid / acceptable values), the default value (when available) and the factory-programmed value (when applicable).

For default value it is intended the value automatically set if the parameter is omitted and at the module power-on (if the command setting is not stored in NVM/profile). For factory-programmed value it is intended the value set at the module power-on when the setting is not modified respect with the manufacturer setting; it is valid for the commands that store the setting in NVM/profile.

The summary table on the top of each command section and the [Appendix B](#) lists all the u-blox cellular modules that support that command.

 The example provided in the command description refers only to the handling provided by the command. It may be not valid for all the products which the document is applied to. The list of allowed values for a specific product is provided in the corresponding "Defined values" section.

 In this document <CR><LF> are intentionally omitted in the command syntax.

 If a parameter is omitted, no value will be inserted between the two commas indicating the interested parameter in the command line sent by the DTE.

1.3.1 Default values

If the command parameters are optional, they can be left out in the command line. If not otherwise specified, the default values are assumed as follows:

- For parameters of type Number, the default value is 0
- For parameters of type String, the default value is an empty string

1.3.2 Command line

The AT commands are typically issued to the cellular modules using a command line with the following generic syntax:

```
"AT"<command_name><string><S3_character>
```

Where:

- "AT": prefix to be set at the beginning of each command line
- <command_name>: command name string; it can have a "+" character as prefix
- <string>: string consisting of the parameters value following the syntax provided in this manual

The following rules are used when describing the command syntax:

- o <...>: the name in angle brackets is a parameter. The brackets themselves do not appear in the command line
- o [...]: the square brackets represent the optional parameters of a command or an optional part of the DCE information text response. Brackets themselves do not appear in the command line. When a parameter is not given, the value will be set to the default value provided in the command description

Parameter types:

- o Number: positive and negative counting numbers, as well as zero {..., -2, -1, 0, 1, 2,...}.
- o String: sequence of characters enclosed within quotation marks (" ").
- <S3_character>: command line termination character; the factory-programmed termination character is <CR>

 The maximum length of the command line is the maximum number of characters which can be accepted on a single command line (including the command line termination character).

 SARA-R4 / SARA-N4
The command line is not case sensitive unless autobauding is enabled; in this case the prefix "AT" must be typed either as "AT" or "at"; other combinations ("aT" or "Ta") are not allowed.

 When writing or sending an SMS, Ctrl-Z or ESC terminates the command; <CR> is used between the two parts of the SMS (address and text).

The serial interface driver generally does not allow a new command until the previous one has been terminated by "OK" final result code or by an error result code. In specific cases (see the abortability attribute), the command execution may be aborted if a character is sent to DCE before the command has ended.

1.3.2.1 Concatenation of AT commands

More than one AT command can be entered on the same command line. The "AT" prefix must be provided only at the beginning of the command line. Each command must be separated by using a semicolon as delimiter only if the command has a "+" character as prefix.

```
Example: ATI;+CGATT?;+COPS?<CR>
```

If a command in the command line causes an error, or is not recognized as a valid command, then the execution is terminated, the remaining commands in the command line are ignored and an error result code is returned.

If all the commands are correctly executed, only the "OK" final result code of the last command is returned.

 SARA-R4 / SARA-N4
Not all the commands can be entered with other commands on the same command line: **+CMGW**, **+CMGS**, **+USOWR**, **+USOST**, **+UDWNFILE** must be used by themselves.

1.3.3 Notes

SARA-R422 / SARA-R422M8S / SARA-R422S

- The maximum length of the command line is 2100 characters.
- String parameter type limitations - The following characters are not allowed in the parameter string:
 - o 0x00 (NUL)
 - o 0x0D (CR)
 - o 0x15 (NAK)
 - o 0x22 (")
 - o 0x2C (,)

SARA-R410M-02B / SARA-R410M-52B / SARA-R410M-63B / SARA-R410M-73B / SARA-R410M-83B

- The maximum length of the command line is 2600 characters.
- String parameter type limitations - The following characters are not allowed in the parameter string:
 - o 0x00 (NUL)
 - o 0x0D (CR)
 - o 0x15 (NAK)
 - o 0x22 (")
 - o 0x2C (,)



SARA-R410M-02B / SARA-R410M-52B / SARA-R412M

On SARA-R410M-02B-00, SARA-R410M-02B-01, SARA-R410M-52B-00, SARA-R410M-52B-01, SARA-R412M-02B-00, SARA-R412M-02B-01 the maximum length of the command line is 1600 characters.

SARA-R404M / SARA-R410M-01B / SARA-N4

- The maximum length of the command line is 1600 characters.
- String parameter type limitations - The following characters are not allowed in the parameter string:
 - o 0x00 (NUL)
 - o 0x0D (CR)
 - o 0x15 (NAK)
 - o 0x22 (")
 - o 0x2C (,)

1.3.4 Information text responses and result codes

The AT command response comprises an optional information text string and a final result code that can assume the format as follows:

- **Verbose format:**
Information text response(s): <S3_character><S4_character><text><S3_character><S4_character>
Final result code: <S3_character><S4_character><verbose code><S3_character><S4_character>
- **Numerical format:**
Information text response(s): <text><S3_character><S4_character>
Final result code: <numerical_code><S3_character>

where

- <S3_character> is the command line termination character
- <S4_character> is the linefeed character



SARA-R4 / SARA-N4

The **V** AT command configures the result code in numeric or verbose format.

The command line termination character can be set with **S3** AT command.

The linefeed character can be set with **S4** AT command.

Table 1 lists the allowed result codes.

| Verbose | Numeric | Result code type | Description |
|---------|---------|------------------|---|
| OK | 0 | Final | Command line successfully processed and the command is correctly executed |
| CONNECT | 1 | Intermediate | Data connection established |
| RING | 2 | Unsolicited | Incoming call signal from the network |

| Verbose | Numeric | Result code type | Description |
|----------------------|---------|------------------|--|
| NO CARRIER | 3 | Final | Connection terminated from the remote part or attempt to establish a connection failed |
| ERROR | 4 | Final | General failure. The <code>+CMEE</code> AT command configures the error result format |
| NO DIALTONE | 6 | Final | No dialtone detected |
| BUSY | 7 | Final | Engaged signal detected (the called number is busy) |
| NO ANSWER | 8 | Final | No hang up detected after a fixed network timeout |
| CONNECT<data rate> | 9 | Intermediate | Same as CONNECT including also the data rate (data call). |
| NOT SUPPORT | 10 | Final | Operation not supported |
| INVALID COMMAND LINE | 11 | Final | Invalid command line |
| CR | 12 | Final | Carriage return |
| SIM DROP | 13 | Final | SIM not inserted |
| Command aborted | 3000 | Final | Command execution aborted issuing a character to the DCE |
| DISCONNECT | 14 | Final | Data connection disconnected |
| ABORTED | 18 | Final | Aborted terminal |

Table 1: Allowed result codes

 SARA-R4 / SARA-N4
The `DISCONNECT` result code is not supported.

 SARA-R4 / SARA-N4
The `ABORTED` result code is not supported.

 SARA-R4 / SARA-N4
These result codes are not supported: `NOT SUPPORT`, `INVALID COMMAND LINE`, `CR`, `SIM DROP`.

As already stated in the [Preface](#) section (see the "Can be aborted" attribute), some AT commands can be aborted after having issued them.

 SARA-R4 / SARA-N4
The AT commands cannot be aborted, except if explicitly stated in the corresponding AT command description.

Intermediate outputs as well as descriptive outputs of a command are formatted as information text responses; if more than one string has to be printed out (see for example the `+CGDCONT` command description), additional command line termination and linefeed characters may be inserted for sake of readability.

If the command is not accepted by the MT an error result code will be displayed. The `+CMEE` AT command configures the error result code format as follows:

- "+CMS ERROR: <err>" for SMS-related AT commands
- "+CME ERROR: <err>" for any other AT commands

where <err> represents the verbose or numeric error result code depending on the `+CMEE` AT command setting.

The most typical error result codes are the following:

- If the command is not supported or unknown, either "+CME ERROR: unknown" or "+CME ERROR: operation not supported" is sent
- If the command syntax is wrong, "+CME ERROR: operation not supported" is sent ("+CMS ERROR: operation not supported" for SMS related commands)

The list of all the possible error result codes is available in [Appendix A.1](#) and [Appendix A.2](#). For some commands only the "ERROR" final result code is displayed and is documented in the command description.

The proprietary AT commands supporting the following features implement a different error management and provide different error result codes:

- SARA-R4 / SARA-N4 - Firmware update Over The Air: see the [Appendix A.3](#)
- SARA-R4 / SARA-N4 - Firmware update Over AT command: see the [Appendix A.4](#)
- SARA-R422 / SARA-R422M8S / SARA-R422S - DNS: see the [Appendix A.5](#) and [Appendix A.6](#)
- SARA-R410M / SARA-R412M / SARA-N4 - DNS: see the [Appendix A.6](#)
- SARA-R4 / SARA-N4 - TCP and UDP connections: see the [Appendix A.6](#), [Appendix A.7](#)

- SARA-R404M / SARA-R410M / SARA-R412M / SARA-R422M8S / SARA-R422S / SARA-N4 - FTP: see the [Appendix A.7.1](#)
- SARA-R404M / SARA-R410M / SARA-R412M / SARA-R422M8S / SARA-R422S / SARA-N4 - HTTP: see the [Appendix A.7.2](#)
- SARA-R410M / SARA-R412M / SARA-R422M8S / SARA-R422S / SARA-N4 - MQTT: see the [Appendix A.7.4](#)
- SARA-R422M8S / SARA-R422S - MQTT-SN: see the [Appendix A.7.5](#)
- SARA-R422M8S / SARA-R422S - IP change notification: see the [Appendix A.8](#)
- SARA-R422M8S / SARA-R422S - CoAP: see the [Appendix A.7.6](#)
- SARA-R422 / SARA-R422M8S / SARA-R422S - Ping: see the [Appendix A.9](#)

The corresponding sections provide more details for retrieving the error result codes for these operations.

1.4 Storing of AT commands setting

Several user settings may be stored in the cellular module's memory. Some are directly stored in the non volatile memory (NVM), while the others are organized into two personal profiles.

[Appendix B.2](#) lists the complete settings that can be directly stored in NVM and the corresponding commands.



SARA-R4 / SARA-N4

The module does not store the AT commands setting in the personal profiles.

1.5 S-parameters

The S-parameters, as specified in ITU-T recommendation V250 [184], constitute a group of commands that begin with the string "ATS". They are generally indicated as S registers and are used to configure the way the module operates. Their syntax is:

```
ATS<parameter_number>?
```

```
ATS<parameter_number>=<value>
```

The number following the "ATS" is the referenced S parameter.

u-blox cellular modules support the following set of S-parameters (<parameter_number>):

| AT command | S Number | Description |
|------------|----------|--|
| S2 | 2 | Escape character setting |
| S3 | 3 | Command line termination character setting |
| S4 | 4 | Response formatting character setting |
| S5 | 5 | Command line editing character setting |
| S6 | 6 | Pause before blind dialling setting |
| S7 | 7 | Connection completion timeout setting |
| S8 | 8 | Command dial modifier time setting |
| S10 | 10 | Automatic disconnect delay setting |
| S12 | 12 | Escape prompt delay setting |



If a <parameter_number> other than those listed above is introduced, the S command returns an error result code (+CME ERROR: operation not supported).

1.6 +UDCONF AT command

The UDCONF AT commands constitute a group of u-blox proprietary AT commands that allow to configure some features belonging to i.e network services, internet suite, etc. They are indicated by the "+UDCONF=" string followed by an <op_code> (i.e. +UDCONF=20). The allowed <op_code> values depend on the module series.

The generic set command syntax is:

```
AT+UDCONF=<op_code>,<param1>,<param2>,...
```

while the generic read command syntax is

```
AT+UDCONF=<op_code>
```

The test command syntax is defined as follows:

```
+UDCONF: <op_code1>,(supported <op_code1_param1>),(supported <op_code1_param2>),..
```

```
+UDCONF: <op_code2>,(supported <op_code2_param1>),(supported <op_code2_param2>),..
```

```
+UDCONF: <op_code3>,(supported <op_code3_param1>),(supported <op_code3_param2>),..
```

OK

The test command syntax for <op_code>=110 (NVM RAM mode management) differs respect with the other <op_code> values:

```
+UDCONF: 110, "audio", "+CLVL, +CRSL, +UMGC, +USGC, +UMSEL, +UMAFE, +USAFE, +UI2S, +USPM"
```

The string after the <at_group> parameter (i.e. "audio") lists the commands that are impacted by the corresponding "command class". The allowed values for the <at_group> parameter (i.e. AT+UDCONF=110, "audio") are provided by means of the corresponding read command.

2 General operation

2.1 Start up and initialization

The characteristics of the boot of the cellular device vary from module to module and are described in the corresponding system integration manual. During the boot phase the module might not respond to the AT interface until all necessary SW modules have been installed (e.g. USB drivers). Monitoring of the greeting text, where supported, can help in detecting the successful end of the boot phase.

A complete start up including cellular network operation can only take place with a SIM card.



SARA-R4

If the SIM card has enabled the PIN check, some commands answer with "+CME ERROR: SIM PIN required" and most cellular functionalities are not started. After entering the required PIN via the **+CPIN** command, or if booting with a SIM with disabled PIN check, SIM initialization is carried out and a lot of SIM files are read: it is possible that some commands (e.g. phonebook AT commands) are affected by this preliminary phase, resulting in a temporary error response.

2.1.1 Auto-registration

If the **+COPS** <mode> parameter in the profiles or in NVM is left to its factory-programmed value 0 or is set to 1, then after SIM initialization, all u-blox modules will automatically perform PLMN selection and registration for circuit switched/non EPS services as well as packet switched/EPS services. Auto-registration (also sometimes called "auto-COPS", not to be confused with automatic <mode>=0) will also be triggered at SIM insertion, for modules supporting SIM hot insertion, or at SIM driver recovery, occurring when the communication with the SIM card is re-established by the module after an unrecoverable error, caused e.g. by mechanical vibrations or electrical interference.



SARA-R4 / SARA-N4

If no SIM is inserted in the module, the module will not start cell selection even if it is in automatic PLMN selection mode.



SARA-R4 / SARA-N4

During the auto-registration any further network request (by means of **AT+COPS=0** or **AT+COPS=1**) is processed immediately.



SARA-R4 / SARA-N4

The radio access technology selected by the module at start up is defined by the <1stAct> parameter of the **+URAT** command; afterwards the module will reselect the RAT based on the requirements of the cellular standards it complies with and it is not possible to force it to remain in a given RAT unless it is locked on it via **+URAT**.

The user can retrieve the result of the auto-registration by polling the registration status commands (e.g. **+CREG**/**+CGREG**/**+CEREG**/**+CIREG**) or enabling their unsolicited notifications. If auto-COPS is running, at boot time or at SIM insertion, network service commands issued by the user might have a longer response time than expected; this is particularly visible when the module is switched on in a jammed condition, or with a roaming SIM card that shall perform several registration attempts before gaining access to a VPLMN. In case of failures of the automatic registration whose cause cannot be retrieved via **+CEER**, it is suggested to disable auto-COPS starting the module in **+COPS: 2** or in airplane mode **+CFUN: 4** and trigger registration with AT commands.

2.1.2 Operational restrictions

Operational restrictions may derive from several settings: PIN required, SIM lock, invalidation of the IMEI or SIM credentials by the Mobile Network Operator (MNO) during the registration procedure, FDN enabled. Restrictions to access the network are also applied by the module in any one of these conditions:

- In eCall only state (for all modules supporting the eCall feature)
- In minimum functionality power modes (**+CFUN: 0**, **+CFUN: 4**, **+CFUN: 19**, **+CFUN: 127**), and even if the module is restarted in **+CFUN: 4** or **+CFUN: 19** modes, because they are persistent

In case the module is in operational restricted state, it may reject all or specific service requests (e.g. operator selection, connection establishment).

2.2 AT commands types

2.2.1 Action command

An action command forces the DCE to print information text or execute a specific action for the command. A typical example of this command type is the provision of the factory-programmed settings of the DCE like manufacturer name, firmware version, etc.

2.2.2 Set command

A set command configures the preferred settings for the specified command. The set command is the only way to set the preferred settings in the DCE. For some commands it is possible to store the current settings in the profile or in the non volatile memory and retrieve them in another connection.

2.2.3 Read command

A read command provides the current setting of the command parameters. It is used to find out the current command configuration.

2.2.4 Test command

A test command provides the list of the values allowed by each parameter of the command.

2.2.5 Unsolicited Result Code (URC)

An unsolicited result code is a string message (provided by the DCE) that is not triggered as a information text response to a previous AT command and can be output, when enabled, at any time to inform the DTE of a specific event or status change.

The URC can have the same name of the command that enables it (e.g. **+CREG**) or can be enabled by another command (e.g. the **+CMTI** URC must be enabled by **+CNMI** AT command).

2.2.5.1 URCs presentation deferring

Since the URCs are text responses issued by the DCE without being requested by the DTE, their occurrence is completely uncorrelated to an AT command execution. Therefore, a collision between a URC and an AT command response might occur and it may lead the DTE to misunderstand the URC as part of the AT command's text response or viceversa.

The module avoids this collision by delaying the URCs presentation in case the AT command interface is busy. The AT command interface can be busy in the following cases:

- During a data call (data mode)
- During the execution of an AT command in command or online command mode

The command execution starts when the command line is completed by the command line termination character and the AT interpreter in the module accepts it; the command execution ends when the final result code for the command is sent out. Inside this period, the module is not allowed to send the not buffered URCs. For most of the messages, the DCE needs to be configured whether or not to send a URC. After enabling, for most of the URCs, if the AT command interface is busy, the pending URCs are buffered and their sending to the DCE is deferred. The RING indication is always generated as an unsolicited result code. The NO CARRIER indication is generated as an unsolicited result code when it has not to be considered the final response for the executing command (e.g.: ATH); in case it is handled as an unsolicited result code, it follows the rule of the other URCs.

Generally, the buffered URCs are sent to the terminal as soon as the terminal exits the data mode or the command execution is terminated. An exception to this behavior is implemented for the following URCs classes:

| Class | AT command to configure the class |
|-------------------------------------|-----------------------------------|
| Reception of a new SMS related URCs | +CNMI AT command |
| +CIEV URCs | +CMER AT command |

For the above classes, it is possible to select the presentation strategy in case of AT interface busy according the 3GPP TS 27.007 [58]; the buffering or discarding are the two possible choices (URCs are lost in the latter case). This is done by means of the corresponding AT command (see the AT command listed in the table above).

If the URCs are enabled or for the three described classes of URCs, the buffered URCs are sent out only when the AT interface is in idle again; this occurs as soon as:

- The data mode is released (the data call is disconnected)
- The final result code for an AT command is issued



The DTE should wait some time (the recommended value is at least 20 ms) after the reception of an AT command final result code or URC before issuing a new AT command to give the DCE the opportunity to transmit the buffered URCs. Otherwise the collision of the URCs with the subsequent AT command is still possible.



In case multiple AT interfaces are available, it should be advisable to use one of the different AT interfaces to manage all the user enabled URCs, while use the others ones to send AT commands and receive their responses.

Anyway URCs related to external causes (e.g. RING) are issued on all interfaces.

2.2.6 Intermediate Result Code (IRC)

An intermediate result code is a string message (provided by the DCE) which provides to the DTE some information about the processing status of the pending AT command.

3 IPC - Inter Processor Communication

3.1 Multiplexing mode +CMUX

| +CMUX | | | | | | |
|-------------------|---------------|---------------------|-----------------------|-----------------------|----------------------|------------------------|
| Modules | All products | | | | | |
| Attributes | Syntax | PIN required | Settings saved | Can be aborted | Response time | Error reference |
| | partial | No | No | No | - | +CME Error |

3.1.1 Description

Enables the multiplexing protocol control channel as defined in 3GPP TS 27.010 [87]. The command sets the parameters for the control channel. The result code is returned using the old interface speed. The parameters become active only after sending the OK result code.

The usage of +CMUX set command during the multiplexing is not allowed.

The multiplexer configuration is as follows:

| Modules | Control channel | AT commands / data GNSS tunneling connection | SAP (SIM Access Profile) |
|---|-----------------|--|--------------------------|
| SARA-R404M / SARA-R410M-01B | Channel 0 | Channel 1 - 3 | |
| SARA-R410M-02B / SARA-R410M-52B / SARA-R410M-63B / SARA-R410M-73B / SARA-R410M-83B / SARA-R412M / SARA-R422M8S / SARA-R422S | Channel 0 | Channel 1 - 2 | Channel 3 |
| SARA-R422 | Channel 0 | Channel 1 - 2 | |
| SARA-N4 | Channel 0 | Channel 1 - 2 | Channel 3 |

Table 2: Multiplexer configuration

3.1.2 Syntax

| Type | Syntax | Response | Example |
|------|--|---|--|
| Set | AT+CMUX=<mode>[,<subset>[,<port_speed>[,<N1>[,<T1>[,<N2>[,<T2>[,<T3>[,<k>]]]]]]] | OK | AT+CMUX=0,0,,1500,50,3,90 OK |
| Read | AT+CMUX=? | +CMUX: <mode>[,<subset>[,<port_speed>[,<N1>[,<T1>[,<N2>[,<T2>[,<T3>[,<k>]]]]]]] OK | +CMUX: 0,0,0,1500,253,3,254,0,0 OK |
| Test | AT+CMUX=? | +CMUX: (list of supported <mode>s),(list of supported <subset>s),(list of supported <port_speed>s),(list of supported <N1>s),(list of supported <T1>s),(list of supported <N2>s),(list of supported <T2>s),(list of supported <T3>s),(list of supported <k>s) OK | +CMUX: (0),(0),,(1-1509),(1-255),(0-5),(2-255),, OK |

3.1.3 Defined values

| Parameter | Type | Description |
|-----------|--------|---|
| <mode> | Number | Multiplexer transparency mechanism: <ul style="list-style-type: none"> 0: basic option |
| <subset> | Number | The way in which the multiplexer control channel is set up: <ul style="list-style-type: none"> 0 (default value): UIH frames used only |

| Parameter | Type | Description |
|--------------|--------|--|
| | | <ul style="list-style-type: none"> 1: UI frames used only See Notes for the parameter applicability. |
| <port_speed> | Number | Transmission rate. The allowed range is 0-7. This parameter is ignored and the value 0 is always displayed in case of read command. |
| <N1> | Number | Maximum frame size: <ul style="list-style-type: none"> Allowed range is 1-1509. The default value is 31. |
| <T1> | Number | Acknowledgement timer in units of ten milliseconds. The allowed range is 1-255. This parameter is ignored and the value 253 is always set. |
| <N2> | Number | Maximum number of re-transmissions: <ul style="list-style-type: none"> Allowed range is 0-5. The default value is 3. |
| <T2> | Number | Response timer for the multiplexer control channel in units of ten milliseconds. The allowed range is 2-255. This parameter is ignored and the value 254 is always set. |
| <T3> | Number | Wake up response timer. The allowed range is 0-255. This parameter is ignored and the value 0 is always displayed in case of the read command. |
| <k> | Number | Window size, for advanced operation with Error Recovery options. The allowed range is 0-255. This parameter is ignored and the value 0 is always displayed in case of the read command. |

3.1.4 Notes

- If the multiplexer protocol is not started (the +CMUX set command has not been issued or returned an error result code) and [AT+CMEE](#) is set to 2, the +CMUX read command returns the following error result code: +CME ERROR: operation not allowed.
- For complete compatibility between u-blox products, leave the unsupported/unused parameters blank (which are reported as blank by the +CMUX test command).
- <T1> must be lower than or equal to <T2>.

SARA-R404M / SARA-R410M / SARA-R412M / SARA-N4

- <subset> can only assume the value 0.
- <T1>, <T2>, <N2> values are ignored, since the related timers are not implemented.
- The command is only supported on the UART interface. It cannot be used on the USB interface.

SARA-R422 / SARA-R422M8S / SARA-R422S

- <subset> can only assume the value 0.
- <T1>, <T2>, <N2> values are ignored, since the related timers are not implemented.
- The command is only supported on the UART interface. It cannot be used on the USB interface.
- The multiplexer protocol is not supported when the AUX UART interface is activated (for more details, see [+USIO](#) AT command, <requested_variant>=1 or 4).

4 General

4.1 Manufacturer identification +CGMI

| +CGMI | | | | | | |
|-------------------|---------------|---------------------|-----------------------|-----------------------|----------------------|----------------------------|
| Modules | All products | | | | | |
| Attributes | Syntax | PIN required | Settings saved | Can be aborted | Response time | Error reference |
| | full | No | No | No | - | +CME Error |

4.1.1 Description

Text string identifying the manufacturer.

4.1.2 Syntax

| Type | Syntax | Response | Example |
|--------|-----------|----------------------|--------------|
| Action | AT+CGMI | <manufacturer> OK | u-blox OK |
| Test | AT+CGMI=? | OK | |

4.1.3 Defined values

| Parameter | Type | Description |
|----------------|--------|-------------------|
| <manufacturer> | String | Manufacturer name |

4.2 Manufacturer identification +GMI

| +GMI | | | | | | |
|-------------------|---------------|---------------------|-----------------------|-----------------------|----------------------|----------------------------|
| Modules | All products | | | | | |
| Attributes | Syntax | PIN required | Settings saved | Can be aborted | Response time | Error reference |
| | full | No | No | No | - | +CME Error |

4.2.1 Description

Text string identifying the manufacturer.

4.2.2 Syntax

| Type | Syntax | Response | Example |
|--------|--------|----------------------|--------------|
| Action | AT+GMI | <manufacturer> OK | u-blox OK |

4.2.3 Defined values

| Parameter | Type | Description |
|----------------|--------|-------------------|
| <manufacturer> | String | Manufacturer name |

4.3 Model identification +CGMM

| +CGMM | | | | | | |
|-------------------|---------------|---------------------|-----------------------|-----------------------|----------------------|----------------------------|
| Modules | All products | | | | | |
| Attributes | Syntax | PIN required | Settings saved | Can be aborted | Response time | Error reference |
| | full | No | No | No | - | +CME Error |

4.3.1 Description

Text string identifying the model identification.

4.3.2 Syntax

| Type | Syntax | Response | Example |
|--------|-----------|---------------|-----------------|
| Action | AT+CGMM | <model> OK | LISA-U200 OK |
| Test | AT+CGMM=? | OK | |

4.3.3 Defined values

| Parameter | Type | Description |
|-----------|--------|---------------|
| <model> | String | Name of model |

4.3.4 Notes

SARA-R4 / SARA-N4

- The action command returns the product ordering code instead of the name of model.

4.4 Model identification +GMM

| +GMM | | | | | | |
|------------|--------------|--------------|----------------|----------------|---------------|----------------------------|
| Modules | All products | | | | | |
| Attributes | Syntax | PIN required | Settings saved | Can be aborted | Response time | Error reference |
| | full | No | No | No | - | +CME Error |

4.4.1 Description

Text string identifying the model identification.

4.4.2 Syntax

| Type | Syntax | Response | Example |
|--------|--------|---------------|-----------------|
| Action | AT+GMM | <model> OK | LISA-U120 OK |

4.4.3 Defined values

| Parameter | Type | Description |
|-----------|--------|---------------|
| <model> | String | Name of model |

4.4.4 Notes

SARA-R4 / SARA-N4

- The action command returns the product ordering code instead of the name of model.

4.5 Firmware version identification +CGMR

| +CGMR | | | | | | |
|------------|--------------|--------------|----------------|----------------|---------------|----------------------------|
| Modules | All products | | | | | |
| Attributes | Syntax | PIN required | Settings saved | Can be aborted | Response time | Error reference |
| | full | No | No | No | - | +CME Error |

4.5.1 Description

Returns the firmware version of the module.

4.5.2 Syntax

| Type | Syntax | Response | Example |
|--------|-----------|-----------------|-------------|
| Action | AT+CGMR | <version> OK | 11.40 OK |
| Test | AT+CGMR=? | OK | |

4.5.3 Defined values

| Parameter | Type | Description |
|-----------|--------|---|
| <version> | String | Firmware version  SARA-R4 / SARA-N4 The firmware version is returned together with its release date reported within square brackets. |

4.6 Firmware version identification +GMR

| +GMR | | | | | | |
|------------|--------------|--------------|----------------|----------------|---------------|----------------------------|
| Modules | All products | | | | | |
| Attributes | Syntax | PIN required | Settings saved | Can be aborted | Response time | Error reference |
| | full | No | No | No | - | +CME Error |

4.6.1 Description

Returns the firmware version of the module.

4.6.2 Syntax

| Type | Syntax | Response | Example |
|--------|--------|-----------|---------|
| Action | AT+GMR | <version> | 11.40 |
| | | OK | OK |

4.6.3 Defined values

| Parameter | Type | Description |
|-----------|--------|---|
| <version> | String | Firmware version  SARA-R4 / SARA-N4 The firmware version is returned together with its release date reported within square brackets. |

4.7 Request product serial number identification +CGSN

| +CGSN | | | | | | |
|------------|--------------|--------------|----------------|----------------|---------------|----------------------------|
| Modules | All products | | | | | |
| Attributes | Syntax | PIN required | Settings saved | Can be aborted | Response time | Error reference |
| | partial | No | No | No | - | +CME Error |

4.7.1 Description

Returns the International Mobile station Equipment Identity (IMEI) number and related information to identify the MT that the TE is connected to.

4.7.2 Syntax

| Type | Syntax | Response | Example |
|------------------------------|-----------------|----------------------|--------------------------|
| Generic syntax | | | |
| Set | AT+CGSN[=<snt>] | [+CGSN:]<param_val> | AT+CGSN=0 |
| | | OK | 357520070120767 |
| | | OK | OK |
| Serial number request | | | |
| Set | AT+CGSN[=0] | <sn> | AT+CGSN |
| | | OK | 357520070120767 |
| | | OK | OK |
| IMEI request | | | |
| Set | AT+CGSN=1 | +CGSN: <imei> | AT+CGSN=1 |
| | | OK | +CGSN: "357520070120767" |

| Type | Syntax | Response | Example |
|----------------------------------|-------------|---|--|
| | | | OK |
| IMEISV request | | | |
| Set | AT+CGSN=2 | +CGSN: <imeisv> OK | AT+CGSN=2 +CGSN: "3575200701207601" OK |
| SVN request | | | |
| Set | AT+CGSN=3 | +CGSN: <svn> OK | AT+CGSN=3 +CGSN: "01" OK |
| Full IMEI and SVN request | | | |
| Set | AT+CGSN=255 | <imei_full> OK | AT+CGSN=255 35752007012076701 OK |
| Test | AT+CGSN=? | +CGSN: (list of supported <snt>s) OK | +CGSN: (0-3,255) OK |

4.7.3 Defined values

| Parameter | Type | Description |
|-------------|-------------------|---|
| <snt> | Number | It indicates the requested serial number type. Depending on <snt> value, the <param_val> parameter in the information text response provides different information: <ul style="list-style-type: none"> • 0 (default value): MT serial number, typically the International Mobile station Equipment Identity (IMEI) • 1: International Mobile station Equipment Identity (IMEI) • 2: International Mobile station Equipment Identity and Software Version Number (IMEISV) • 3: Software Version Number (SVN) • 255: IMEI (not including the spare digit), the check digit and the SVN |
| <sn> | Number | MT serial number, typically the International Mobile station Equipment Identity (IMEI) |
| <imei> | String | International Mobile station Equipment Identity (IMEI). IMEI is composed of Type Allocation Code (TAC) (8 digits), Serial Number (SNR) (6 digits) and the Check Digit (CD) (1 digit). |
| <imeisv> | String | International Mobile station Equipment Identity and Software Version Number (IMEISV). The 16 digits of IMEISV are composed of Type Allocation Code (TAC) (8 digits), Serial Number (SNR) (6 digits) and the software version (SVN) (2 digits). |
| <svn> | String | Software Version Number (SVN) which is a part of IMEISV. |
| <imei_full> | Number | International Mobile station Equipment Identity (IMEI), Check Digit and Software Version Number. |
| <param_val> | Number/ String | Type and supported content depend on related <snt> (details are given above) |

4.7.4 Notes

SARA-R4 / SARA-N4

- The <snt> parameter is not supported.
- The response to the test command does not provide the information text response.

4.8 IMEI identification +GSN

| +GSN | | | | | | |
|-------------------|---------------|---------------------|-----------------------|-----------------------|----------------------|----------------------------|
| Modules | All products | | | | | |
| Attributes | Syntax | PIN required | Settings saved | Can be aborted | Response time | Error reference |
| | full | No | No | No | - | +CME Error |

4.8.1 Description

The commands handling is the same of [+CGSN](#).

4.8.2 Syntax

| Type | Syntax | Response | Example |
|--------|----------------|----------|-----------------|
| Action | AT+GSN[=<snt>] | <sn> | 004999010640000 |
| | | OK | OK |
| Test | AT+GSN=? | OK | |

4.8.3 Defined values

See [+CGSN](#) AT command.

4.9 Identification information I

| I | | | | | | |
|-------------------|---------------|---------------------|-----------------------|-----------------------|----------------------|----------------------------|
| Modules | All products | | | | | |
| Attributes | Syntax | PIN required | Settings saved | Can be aborted | Response time | Error reference |
| | partial | No | No | No | - | +CME Error |

4.9.1 Description

Returns some module information as the module type number and some details about the firmware version.



The information text response of ATi9 contains the modem version and the application version of the module where applicable; it returns "Undefined" where not applicable.

4.9.2 Syntax

| Type | Syntax | Response | Example |
|--------|--|---|---|
| Action | Module information request ATI | Manufacturer: <manufacturer> Model: <ordering_code> Revision: <modem_version> [<FW_ rel_date>] SVN: <SVN> IMEI: <IMEI> OK | ATI Manufacturer: u-blox Model: SARA-R412M-02B Revision: M0.05.00 [Jul 06 2018 10:01:55] SVN: 02 IMEI: 354679090015846 OK |
| | Type number request ATi0 | <type_number> OK | ATi0 SARA-R410M-63B-00 OK |
| | Modem and application version request ATi9 | <modem_version>,<applications_ version> OK | ATi9 M0.09.00,A.02.11 OK |

4.9.3 Defined values

| Parameter | Type | Description |
|----------------|--------|-------------------|
| <manufacturer> | String | Manufacturer name |

| Parameter | Type | Description |
|--------------------------------|--------|--|
| <type_number> | String | Product type number |
| <ordering_code> | String | Product ordering code |
| <modem_version> | String | Module modem version |
| <FW_rel_date> | String | Firmware release date and time |
| <applications_version> | String | Module application version. Where not applicable the module provides "Undefined" |
| <SVN> | String | Software Version Number |
| <IMEI> | String | International Mobile Equipment Identity (IMEI) of the MT |
| <module_boot_sequence_version> | Number | Module boot sequence version. Where not applicable the module provides "Undefined" |

4.9.4 Notes

SARA-R404M / SARA-R410M-01B / SARA-R410M-02B / SARA-R410M-52B / SARA-R412M / SARA-N4

- The ATI and ATIO commands return the product ordering code instead of the product type number.

4.10 TE character set configuration +CSCS

| +CSCS | | | | | | |
|------------|--------------|--------------|-------------------------|----------------|---------------|----------------------------|
| Modules | All products | | | | | |
| Attributes | Syntax | PIN required | Settings saved | Can be aborted | Response time | Error reference |
| | full | No | Profile | No | - | +CME Error |

4.10.1 Description

Selects the TE character set.



The selected character set is used for encoding/decoding of only the AT commands' string type parameters whose description explicitly references the +CSCS setting itself.



SARA-R4 / SARA-N4

The command setting is not stored in the profile.

4.10.2 Syntax

| Type | Syntax | Response | Example |
|------|-----------------|--|---|
| Set | AT+CSCS=<chset> | OK | AT+CSCS="IRA" OK |
| Read | AT+CSCS? | +CSCS: <chset> OK | +CSCS: "IRA" OK |
| Test | AT+CSCS=? | +CSCS: (list of supported <chset>'s) OK | +CSCS: ("IRA","GSM","PCCP437", "8859-1","UCS2","HEX", "PCCP936") OK |

4.10.3 Defined values

| Parameter | Type | Description |
|-----------|--------|---|
| <chset> | String | Allowed characters set: <ul style="list-style-type: none"> "IRA" (factory-programmed value): International Reference Alphabet (ITU-T T.50) "GSM": GSM default alphabet (3GPP TS 23.038) "PCCP437": PC character set Code Page 437 "8859-1": ISO 8859 Latin 1 character set "UCS2": 16-bit universal multiple-octet coded character set (USO/IEC10646); UCS2 character strings are converted to hexadecimal numbers from 0000 to FFFF; e.g. "004100620063" equals three 16-bit characters with decimal values 65, 98 and 99 "HEX": character strings consist only of hexadecimal numbers from 00 to FF; e.g. "032FE6" equals three 8-bit characters with decimal values 3, 47 and 230; no conversions to the original MT character set shall be done "PCCP936": Chinese character set Allowed values: |

| Parameter | Type | Description |
|-----------|------|---|
| | | <ul style="list-style-type: none"> SARA-R4 / SARA-N4 - "IRA" (factory-programmed value), "GSM" |

4.10.4 Notes

SARA-R4 / SARA-N4

- The command setting is not stored in the personal profile.

4.11 International mobile subscriber identification +CIMI

| +CIMI | | | | | | |
|------------|--------------|--------------|----------------|----------------|---------------|----------------------------|
| Modules | All products | | | | | |
| Attributes | Syntax | PIN required | Settings saved | Can be aborted | Response time | Error reference |
| | full | Yes | No | No | - | +CME Error |

4.11.1 Description

Request the IMSI (International Mobile Subscriber Identity).

4.11.2 Syntax

| Type | Syntax | Response | Example |
|--------|-----------|--------------|-----------------------|
| Action | AT+CIMI | <IMSI> OK | 222107701772423 OK |
| Test | AT+CIMI=? | OK | |

4.11.3 Defined values

| Parameter | Type | Description |
|-----------|--------|--|
| <IMSI> | Number | International Mobile Subscriber Identity |

4.12 Card identification +CCID

| +CCID | | | | | | |
|------------|--------------|--------------|----------------|----------------|---------------|----------------------------|
| Modules | All products | | | | | |
| Attributes | Syntax | PIN required | Settings saved | Can be aborted | Response time | Error reference |
| | full | No | No | No | - | +CME Error |

4.12.1 Description

Returns the ICCID (Integrated Circuit Card ID) of the SIM-card. ICCID is a serial number identifying the SIM.

4.12.2 Syntax

| Type | Syntax | Response | Example |
|--------|-----------|----------------------|----------------------------------|
| Action | AT+CCID | +CCID: <ICCID> OK | +CCID: 8939107800023416395 OK |
| Read | AT+CCID? | +CCID: <ICCID> OK | +CCID: 8939107900010087330 OK |
| Test | AT+CCID=? | OK | |

4.12.3 Defined values

| Parameter | Type | Description |
|-----------|--------|-----------------------|
| <ICCID> | String | ICCID of the SIM card |

4.12.4 Notes

- The command needs of the SIM to correctly work.

4.13 Request complete capabilities list +GCAP

| +GCAP | | | | | | |
|-------------------|-----------------------------------|---------------------|-----------------------|-----------------------|----------------------|----------------------------|
| Modules | SARA-R422 SARA-R422M8S SARA-R422S | | | | | |
| Attributes | Syntax | PIN required | Settings saved | Can be aborted | Response time | Error reference |
| | full | No | No | No | - | +CME Error |

4.13.1 Description

This command requests the list of capabilities, containing the corresponding command names. The Complete Capabilities List command indicates the major capability areas of the MT. Each area is presented by the selection command name of the specific capability area or some other predefined response.

The first response text (+FCLASS) informs that some fax or voice capabilities are present while the second supported area presented with +CGSM shows that all GSM commands of the present document are supported.

4.13.2 Syntax

| Type | Syntax | Response | Example |
|--------|-----------|---|-----------------------------|
| Action | AT+GCAP | +GCAP: <capability_area 1>[, <capability_area 2>[...]] OK | +GCAP: +FCLASS, +CGSM OK |
| Test | AT+GCAP=? | OK | |

4.13.3 Defined values

| Parameter | Type | Description |
|-------------------|--------|---|
| <capability_area> | String | Command name or predefined response of the specific capability area In the example: +FCLASS response text informs that some fax or voice capabilities are present, while +CGSM response text shows that all GSM commands of the present document are supported by the MT |

4.14 Repeat last command A/

| A/ | | | | | | |
|-------------------|---|---------------------|-----------------------|-----------------------|----------------------|----------------------------|
| Modules | SARA-R404M SARA-R410M SARA-R412M SARA-N4 | | | | | |
| Attributes | Syntax | PIN required | Settings saved | Can be aborted | Response time | Error reference |
| | full | No | No | No | - | +CME Error |

4.14.1 Description

Repeats the previously executed command again. Only the A/ command cannot be repeated.



If autobauding is active, the MT is not able to recognize the command and the command A/ cannot be used.

4.14.2 Syntax

| Type | Syntax | Response | Example |
|--------|--------|----------|---------|
| Action | A/ | | |

5 Mobile equipment control and status

5.1 Phone activity status +CPAS

| +CPAS | | | | | | |
|-------------------|---------------|---------------------|-----------------------|-----------------------|----------------------|----------------------------|
| Modules | All products | | | | | |
| Attributes | Syntax | PIN required | Settings saved | Can be aborted | Response time | Error reference |
| | full | No | No | No | - | +CME Error |

5.1.1 Description

Returns the activity status <pas> of the MT.

5.1.2 Syntax

| Type | Syntax | Response | Example |
|--------|-----------|---|--------------------|
| Action | AT+CPAS | +CPAS: <pas> OK | +CPAS: 0 OK |
| Test | AT+CPAS=? | +CPAS: (list of supported <pas>s) OK | +CPAS: (0-5) OK |

5.1.3 Defined values

| Parameter | Type | Description |
|-----------|--------|---|
| <pas> | Number | MT activity status: <ul style="list-style-type: none"> 0: ready (MT allows commands from DTE) 1: unavailable (MT does not allow commands from DTE) 2: unknown (MT is not guaranteed to respond to instructions) 3: ringing (MT is ready for commands from DTE, but the ringer is active) 4: call in progress (MT is ready for commands from DTE, but a call is in progress, e.g. call active, hold, disconnecting) 5: asleep (ME is unable to process commands from DTE because it is in a low functionality state) Allowed values: <ul style="list-style-type: none"> SARA-R4 / SARA-N4 - 0, 3, 4 |

5.2 Module switch off +CPWROFF

| +CPWROFF | | | | | | |
|-------------------|---------------|---------------------|-----------------------|-----------------------|----------------------|----------------------------|
| Modules | All products | | | | | |
| Attributes | Syntax | PIN required | Settings saved | Can be aborted | Response time | Error reference |
| | full | No | No | No | < 40 s | +CME Error |

5.2.1 Description

Switches off the MT. During shutdown current settings are saved in module's non-volatile memory.



Using this command can result in the following command line being ignored.



See the corresponding System Integration Manual for the timing and the electrical details of the module power-off sequence via the +CPWROFF command.



SARA-R4

The +UCPWROFF URC notifies that the module power-off is in progress. For more details on the module power-off procedure, see the SARA-R4 series system integration manual [14].

5.2.2 Syntax

| Type | Syntax | Response | Example |
|--------|--------------|-----------|-----------|
| Action | AT+CPWROFF | OK | |
| Test | AT+CPWROFF=? | OK | |
| URC | | +UCPWROFF | +UCPWROFF |

5.2.3 Notes

SARA-R404M / SARA-R410M-01B / SARA-R410M-02B / SARA-R410M-52B / SARA-R412M / SARA-N4

- The +UCPWROFF URC is not supported.

5.3 Set module functionality +CFUN

| +CFUN | | | | | | |
|------------|--------------|--------------|----------------|----------------|---------------|-----------------|
| Modules | All products | | | | | |
| Attributes | Syntax | PIN required | Settings saved | Can be aborted | Response time | Error reference |
| | partial | | No | No | No | Up to 3 min |

5.3.1 Description

Selects the level of functionality <fun> in the MT.



SARA-R4 / SARA-N4

If the syntax AT+CFUN=15 or AT+CFUN=16 (resets) or AT+CFUN=127 is used (where supported), the rest of the command line, placed after that will be ignored.



SARA-R4 / SARA-N4



A SW reset started via AT+CFUN=x,1 or AT+CFUN=16 triggers signalling attempts whose number is internally counted by the FW and limited based on mobile network operators' thresholds. The AT&T RPM feature limits the number of SW resets per hour, and might cause the AT command to return an error result code.

5.3.2 Syntax

| Type | Syntax | Response | Example |
|------|-----------------------|--|-------------------------------------|
| Set | AT+CFUN=<fun>[,<rst>] | OK | AT+CFUN=1 OK |
| Read | AT+CFUN? | +CFUN: <power_mode> OK | +CFUN: 1 OK |
| Test | AT+CFUN=? | +CFUN: (list of supported <fun>'s), (list of supported <rst>'s) OK | +CFUN: (0,1,4,15,16,19),(0-1) OK |
| URC | | +UUFASHTSHUTDOWN: <value> OK | +UUFASHTSHUTDOWN: 0 |

5.3.3 Defined values

| Parameter | Type | Description |
|-----------|--------|--|
| <fun> | Number | Selected functionality: <ul style="list-style-type: none"> 0: sets the MT to minimum functionality (disable both transmit and receive RF circuits by deactivating both CS and PS services) 1 (factory-programmed value): sets the MT to full functionality, e.g. from airplane mode or minimum functionality 4: disables both transmit and receive RF circuits by deactivating both CS and PS services and sets the MT into airplane mode. Airplane mode is persistent between power cycles triggered by AT+CFUN=15, AT+CFUN=16 or AT+CPWROFF (where supported). 10: fast and safe power-off, the command triggers a fast shutdown, without sending a detach request to the network, with storage of current settings in module's non-volatile memory. The "OK" final result code indicates the command request was successful, while the +UUFASHTSHUTDOWN URC provides the status of the power-off process. |

| Parameter | Type | Description |
|--------------|--------|---|
| | | <ul style="list-style-type: none"> 15: MT silent reset (with detach from network and saving of NVM parameters), without reset of the SIM card 16: MT silent reset (with detach from network and saving of NVM parameters), with reset of the SIM card 19: sets the MT to minimum functionality by deactivating CS and PS services and the SIM card. Re-enable the SIM card by means of <fun>=0, 1, 4. Allowed values: <ul style="list-style-type: none"> SARA-R422 / SARA-R422M8S / SARA-R422S - 0, 1, 4, 10, 15, 16, 19 SARA-R410M-63B / SARA-R410M-73B / SARA-R410M-83B - 0, 1, 4, 15, 19 SARA-R404M / SARA-R410M-01B / SARA-R410M-02B / SARA-R410M-52B / SARA-R412M / SARA-N4 - 0, 1, 4, 15  SARA-R410M-63B / SARA-R410M-73B / SARA-R410M-83B On SARA-R410M-63B-00, SARA-R410M-63B-01, SARA-R410M-73B-00, SARA-R410M-73B-01, SARA-R410M-83B-00, SARA-R410M-83B-01 the allowed values are: 0, 1, 4, 15. |
| <rst> | Number | Reset mode: <ul style="list-style-type: none"> 0 (default value): do not reset the MT before setting it to the selected <fun> 1: performs a MT silent reset (with detach from network and saving of NVM parameters) with reset of the SIM card before setting it to the selected <fun> |
| <power_mode> | Number | Power mode: <ul style="list-style-type: none"> 0: MT is switched on with minimum functionality 1: MT is switched on 4: MT is in "airplane mode" 5: MT is in "test mode" 19: MT is in minimum functionality with SIM deactivated Allowed values: <ul style="list-style-type: none"> SARA-R410M-63B / SARA-R410M-73B / SARA-R410M-83B / SARA-R422 / SARA-R422M8S / SARA-R422S - 0, 1, 4, 5, 19 SARA-R404M / SARA-R410M-01B / SARA-R410M-02B / SARA-R410M-52B / SARA-R412M / SARA-N4 - 0, 1, 4, 5  SARA-R410M-63B / SARA-R410M-73B / SARA-R410M-83B On SARA-R410M-63B-00, SARA-R410M-63B-01, SARA-R410M-73B-00, SARA-R410M-73B-01, SARA-R410M-83B-00, SARA-R410M-83B-01 the allowed values are: 0, 1, 4, 5. |
| <value> | Number | Allowed values: <ul style="list-style-type: none"> 0: fast power-off ongoing 1: fast power-off completed |

5.3.4 Notes

SARA-R4 / SARA-N4

- The <power_mode> parameter is set to 5 (test mode) after the module enters the non-signalling mode (AT+UTEST=1).
- <fun>=15 resets the SIM card.
- The command will provide an error result code while in Online Command Mode (OLCM).

SARA-R422 / SARA-R422M8S / SARA-R422S

- Only the +UUFASHTUTDOWN: 1 URC is provided after the trigger of <gpio_mode>=24 GPIO functionality.

5.4 Indicator control +CIND

| +CIND | | | | | | |
|------------|--------------|--------------|----------------|----------------|---------------|-----------------|
| Modules | All products | | | | | |
| Attributes | Syntax | PIN required | Settings saved | Can be aborted | Response time | Error reference |
| | | partial | No | No | No | - |

5.4.1 Description

Provides indication states related to network status, battery information and so on.

The set command does not allow setting the values for those indications which are set according to module state (see <descr> parameter).

The list of indications for set and read commands follows the indexes reported in the <descr> parameter, so that the first <ind> corresponds to "battchg" and so on.

For more details, see the 3GPP TS 27.007 [58].

5.4.2 Syntax

| Type | Syntax | Response | Example |
|------|-------------------------------|----------------------------------|--|
| Set | AT+CIND=[<ind>[,<ind>[,...]]] | OK | AT+CIND= OK |
| Read | AT+CIND? | +CIND: <ind>[,<ind>[,...]] OK | +CIND: 5,0,0,0,0,0,0,0,0,0,0,0 OK |
| Test | AT+CIND=? | +CIND: (list of <descr>s) OK | +CIND: ("battchg",(0-5)),("signal", (0-5)),("service",(0,1)),("sounder", (0,1)),("message",(0,1)),("call",(0,1)), (("roam",(0,1)),("smsfull",(0,1)),("gprs", (0-2)),("callsetup",(0-3)),("callheld",(0, ,1)),("simind",(0-2)) OK |

5.4.3 Defined values

| Parameter | Type | Description |
|-----------|--------|---|
| <ind> | Number | Range of corresponding <descr> used to identify the service when an unsolicited indication is provided |
| <descr> | String | Reserved by the norm and their <ind> ranges; it may have the values: <ul style="list-style-type: none"> • "battchg": battery charge level (0-5) • "signal": signal level. See mapping in the Notes below • "service": network service availability <ul style="list-style-type: none"> o 0: not registered to any network o 1: registered to the network o 65535: indication not available • "sounder": sounder activity, indicating when the module is generating a sound <ul style="list-style-type: none"> o 0: no sound o 1: sound is generated • "message": unread message available in <mem1> storage <ul style="list-style-type: none"> o 0: no messages o 1: unread message available • "call": call in progress <ul style="list-style-type: none"> o 0: no call in progress o 1: call in progress • "roam": registration on a roaming network <ul style="list-style-type: none"> o 0: not in roaming or not registered o 1: roaming o 65535: indication not available • "smsfull": indication that an SMS has been rejected with the cause of SMS storage full <ul style="list-style-type: none"> o 0: SMS storage not full o 1: SMS storage full • "gprs": PS indication status: <ul style="list-style-type: none"> o 0: no PS available in the network o 1: PS available in the network but not registered o 2: registered to PS o 65535: indication not available • "callsetup": call set-up: <ul style="list-style-type: none"> o 0: no call set-up o 1: incoming call not accepted or rejected |

| Parameter | Type | Description |
|-----------|------|---|
| | | <ul style="list-style-type: none"> o 2: outgoing call in dialling state o 3: outgoing call in remote party alerting state • "callheld": call on hold: <ul style="list-style-type: none"> o 0: no calls on hold o 1: at least one call on hold • "simind": SIM detection <ul style="list-style-type: none"> o 0: no SIM detected o 1: SIM detected o 2: not available |

5.4.4 Notes

- If the battery charging is not supported, "battchg" always returns 5 (full charge).
- The <descr> values cannot be changed with +CIND set.
- The following mapping of "signal" value to the power level exists:

| "signal" value | Power level |
|----------------|-------------------------|
| 0 | (< -105 dBm or unknown) |
| 1 | (< -93 dBm) |
| 2 | (< -81 dBm) |
| 3 | (< -69 dBm) |
| 4 | (< -57 dBm) |
| 5 | (>= -57 dBm) |

SARA-R422 / SARA-R422M8S / SARA-R422S

- <descr>="sounder", "call", "callsetup" and "callheld" are not supported.

5.5 Configuration of indicator control +UCIND

| +UCIND | | | | | | |
|------------|--------------|--------------|----------------|----------------|---------------|----------------------------|
| Modules | All products | | | | | |
| Attributes | Syntax | PIN required | Settings saved | Can be aborted | Response time | Error reference |
| | full | No | No | No | - | +CME Error |

5.5.1 Description

Allows the configuration of unsolicited results for indications with +CIEV.

5.5.2 Syntax

| Type | Syntax | Response | Example |
|------|-------------------|----------------------|------------------|
| Set | AT+UCIND=[<conf>] | OK | AT+UCIND=7 OK |
| Read | AT+UCIND? | +UCIND: <conf> OK | +UCIND: 7 OK |
| Test | AT+UCIND=? | OK | |

5.5.3 Defined values

| Parameter | Type | Description |
|-----------|--------|---|
| <conf> | Number | <p>The unsigned integer (0 to 4095) is a bitmask representing the list of the indications active for +CIEV URC reporting. The bit position corresponds to the indicator order number (see the <descr> parameter of +CMER). The least significant bit is used for the first indicator.</p> <p>The bits corresponding to unused indicator order numbers (greater than 13) must be set to 0 (setting a <conf> greater than 4095 causes an error). The default value is 4095 (all the indications are enabled).</p> |

5.6 Mobile termination event reporting +CMER

| +CMER | | | | | | |
|-------------------|---------------|---------------------|-----------------------|-----------------------|----------------------|----------------------------|
| Modules | All products | | | | | |
| Attributes | Syntax | PIN required | Settings saved | Can be aborted | Response time | Error reference |
| | partial | No | No | No | - | +CME Error |

5.6.1 Description

Configures sending of URCs from MT to DTE for indications. The <mode> parameter controls the processing of URCs specified within this command.

The URC is generated each time an indicator which is defined in [+CIND](#) command changes status. The code is actually submitted to MT according to the +CMER settings.



SARA-R4 / SARA-N4

The command [+UCIND](#) allows enabling or disabling indicators.

5.6.2 Syntax

| Type | Syntax | Response | Example |
|------|--|---|--|
| Set | AT+CMER=[<mode>[,<keyp>[,<disp>[,<ind>[,<bfr>]]]]] | OK | AT+CMER=1,0,0,2,1 OK |
| Read | AT+CMER? | +CMER: <mode>,<keyp>,<disp>,<ind>,<bfr> OK | +CMER: 1,0,0,0,1 OK |
| Test | AT+CMER=? | +CMER: (list of supported <mode>'s),(list of supported <keyp>'s),(list of supported <disp>'s),(list of supported <ind>'s),(list of supported <bfr>'s) OK | +CMER: (0-3),(0),(0),(0-2),(0,1) OK |
| URC | | +CIEV: <descr>,<value> | |

5.6.3 Defined values

| Parameter | Type | Description |
|-----------|--------|---|
| <mode> | Number | Allowed values: <ul style="list-style-type: none"> 0 (default value): buffer URCs in the MT 1: discard URCs when the V.24 interface is reserved for data; otherwise directly display them on the DTE 2: buffer URCs in MT when the V.24 interface is reserved and flush them after reservation; otherwise directly display them on the DTE 3: same as 1 |
| <keyp> | Number | Allowed values: <ul style="list-style-type: none"> 0: no keypad event reporting |
| <disp> | Number | Allowed values: <ul style="list-style-type: none"> 0: no display event reporting |
| <ind> | Number | Allowed values: <ul style="list-style-type: none"> 0: no indicator event reporting 1: indicator event reporting using the +CIEV URC. Only the indicator events which are not caused by +CIND shall be indicated by the MT to the DTE. 2: indicator event reporting using the +CIEV URC. All the indicator events shall be directed from MT to DTE. |
| <bfr> | Number | Allowed values: <ul style="list-style-type: none"> 0: MT buffer of URCs defined within this command is cleared when <mode> 1...3 is entered 1: MT buffer of URCs defined within this command is flushed to the DTE when <mode> 1...3 is entered (the OK final result code shall be given before flushing the codes). |

| Parameter | Type | Description |
|-----------|--------|---|
| <descr> | Number | <p>Indicates the indicator order number. The name in the brackets indicates the corresponding <descr> parameter of +CIND; <value> is the new value of indicator:</p> <ul style="list-style-type: none"> • 1 ("battchg"): <value> provides the battery charge level (0-5) • 2 ("signal"): <value> provides the signal level <ul style="list-style-type: none"> o 0: < -105 dBm o 1: < -93 dBm o 2: < -81 dBm o 3: < -69 dBm o 4: < - 57 dBm o 5: >= -57 dBm • 3 ("service"): <value> provides the network service availability: <ul style="list-style-type: none"> o 0: not registered to the network o 1: registered to the network • 4 ("sounder"): <value> provides the sounder activity: <ul style="list-style-type: none"> o 0: no sound o 1: sound is generated • 5 ("message"): <value> provides the unread message available in <mem1> storage: <ul style="list-style-type: none"> o 0: no messages o 1: unread message available • 6 ("call"): <value> provides the call in progress: <ul style="list-style-type: none"> o 0: no call in progress o 1: call in progress • 7 ("roam"): <value> provides the registration on a roaming network: <ul style="list-style-type: none"> o 0: not in roaming o 1: roaming • 8 ("smsfull"): <value> provides the SMS storage status: <ul style="list-style-type: none"> o 0: SMS storage not full o 1: SMS Storage full (an SMS has been rejected with the cause of SMS storage full) • 9 ("gprs"): <value> provides the GPRS indication status: <ul style="list-style-type: none"> o 0: no GPRS available in the network o 1: GPRS available in the network but not registered o 2: registered to GPRS o 65535: PS service indication is not available • 10 ("callsetup"): <value> provides the call set-up: <ul style="list-style-type: none"> o 0: no call set-up o 1: incoming call not accepted or rejected o 2: outgoing call in dialing state o 3: outgoing call in remote party alerting state • 11 ("callheld"): <value> provides the call on hold: <ul style="list-style-type: none"> o 0: no calls on hold o 1: at least one call on hold • 12 ("simind"): <value> provides the SIM detection: <ul style="list-style-type: none"> o 0: no SIM detected o 1: SIM detected o 2: not available |

5.6.4 Notes

SARA-R422 / SARA-R422M8S / SARA-R422S

- <descr>=4 ("sounder"), 6 ("call"), 10 ("callsetup") and 11 ("callheld") are not supported.

5.7 Clock +CCLK

| +CCLK | | | | | | |
|-------------------|---------------|---------------------|-----------------------|-----------------------|----------------------|------------------------|
| Modules | All products | | | | | |
| Attributes | Syntax | PIN required | Settings saved | Can be aborted | Response time | Error reference |
| | partial | No | NVM | No | - | +CME Error |

5.7.1 Description

Sets and reads the real-time clock of the MT.

5.7.2 Syntax

| Type | Syntax | Response | Example |
|------|----------------|---------------------|--------------------------------------|
| Set | AT+CCLK=<time> | OK | AT+CCLK="14/07/01,15:00:00+01" OK |
| Read | AT+CCLK? | +CCLK: <time> OK | +CCLK: "14/07/01,15:00:00+01" OK |
| Test | AT+CCLK=? | OK | |

5.7.3 Defined values

| Parameter | Type | Description |
|-----------|--------|--|
| <time> | String | Format is "yy/MM/dd,hh:mm:ss+TZ". Characters indicate year, month, day, hours, minutes, seconds, time zone. <ul style="list-style-type: none"> SARA-R4 / SARA-N4 - The factory-programmed value is "80/01/06,00:00:00+00" Values prior to the factory-programmed value are not allowed. |

5.7.4 Notes

- If the parameter value is out of range, then the "+CME ERROR: operation not supported" or "+CME ERROR: 4" will be provided (depending on the +CMEE AT command setting).
- "TZ": The Time Zone information is represented by two digits. The value is updated during the registration procedure when the automatic time zone update is enabled (using +CTZU AT command) and the network supports the time zone information.
- The Time Zone information is expressed in steps of 15 minutes and it can assume a value in the range that goes from -96 to +96.

SARA-R404M / SARA-R410M-01B / SARA-R410M-52B / SARA-R410M-63B / SARA-R410M-73B / SARA-R410M-83B / SARA-N4

- The command always reports the UTC time regardless of the current +CTZU AT command setting.

SARA-R410M-02B / SARA-R412M

- On SARA-R410M-02B-00, SARA-R410M-02B-01, SARA-R410M-02B-02, SARA-R412M-02B-00, SARA-R412M-02B-01, SARA-R412M-02B-02 the command always reports the UTC time regardless of the current +CTZU AT command setting.

5.8 Set greeting text +CSGT

| +CSGT | | | | | | |
|-------------------|---|---------------------|-----------------------|-----------------------|----------------------|------------------------|
| Modules | SARA-R410M-02B SARA-R410M-52B SARA-R410M-63B SARA-R410M-73B SARA-R410M-83B SARA-R412M SARA-R422 SARA-R422M8S SARA-R422S SARA-N4 | | | | | |
| Attributes | Syntax | PIN required | Settings saved | Can be aborted | Response time | Error reference |
| | partial | No | NVM | No | - | +CME Error |

5.8.1 Description

Configures and activates/deactivates the greeting text. The greeting text configuration's change will be applied at the subsequent boot. If active, the greeting text is shown at boot once, on any AT interface, the first time the TE sets the DTR line to ON state.

5.8.2 Syntax

| Type | Syntax | Response | Example |
|------|-------------------------|--|------------------------------|
| Set | AT+CSGT=<mode>[,<text>] | OK | AT+CSGT=1,"Hello user" OK |
| Read | AT+CSGT? | +CSGT: <text>,<mode> OK | +CSGT: "Hello",0 OK |
| Test | AT+CSGT=? | +CSGT: (list of supported <mode>s), +CSGT: (0-1),49 <lt;text> OK | OK |

5.8.3 Defined values

| Parameter | Type | Description |
|-----------|--------|---|
| <text> | String | Greeting text. The factory-programmed value is the empty string. |
| <mode> | Number | <ul style="list-style-type: none"> 0: turn off the greeting text 1: turn on the greeting text |
| <lt;text> | Number | Maximum length of the <text> parameter. |

5.8.4 Notes

SARA-R410M-02B

- The command is not supported by SARA-R410M-02B-00.

5.9 Automatic time zone update +CTZU

| +CTZU | | | | | | |
|------------|--------------|--------------|----------------|----------------|---------------|-----------------|
| Modules | All products | | | | | |
| Attributes | Syntax | PIN required | Settings saved | Can be aborted | Response time | Error reference |
| | full | Yes | NVM | No | - | +CME Error |

5.9.1 Description

Configures the automatic time zone update via NITZ.



The Time Zone information is provided after the network registration (if the network supports the time zone information).

5.9.2 Syntax

| Type | Syntax | Response | Example |
|------|------------------|--|--------------------|
| Set | AT+CTZU=<on_off> | OK | AT+CTZU=1 OK |
| Read | AT+CTZU? | +CTZU: <on_off> OK | +CTZU: 0 OK |
| Test | AT+CTZU=? | +CTZU: (list of supported <on_off>s) OK | +CTZU: (0-2) OK |

5.9.3 Defined values

| Parameter | Type | Description |
|-----------|--------|--|
| <on_off> | Number | Automatic time zone update: <ul style="list-style-type: none"> 0: automatic time zone via NITZ disabled 1: automatic time zone update via NITZ enabled; if the network supports the service, update the local time to the module (not only time zone) 2: automatic time zone update via NITZ enabled; if the network supports the service, update the GMT time to the module (not only time zone) Allowed values: <ul style="list-style-type: none"> SARA-R4 / SARA-N4 - 0 (factory-programmed value), 1 |

5.10 Time zone reporting +CTZR

| +CTZR | | | | | | |
|-------------------|--|---------------------|-----------------------|-----------------------|----------------------|------------------------|
| Modules | SARA-R410M SARA-R412M SARA-R422 SARA-R422M8S SARA-R422S SARA-N4 | | | | | |
| Attributes | Syntax | PIN required | Settings saved | Can be aborted | Response time | Error reference |
| | partial | Yes | NVM | No | - | +CME Error |

5.10.1 Description

Configures the time zone change event reporting. If the reporting is enabled, according with the <mode> parameter the MT returns:

- the **+CTZV** URC whenever the time zone changes and additionally the **+CTZDST** URC if the daylight saving time information is available
- the **+CTZE** URC
- the **+CTZEU** URC whenever the universal time reporting is available

5.10.2 Syntax

| Type | Syntax | Response | Example |
|------|----------------|--|----------------------------------|
| Set | AT+CTZR=<mode> | OK | AT+CTZR=1 OK |
| Read | AT+CTZR? | +CTZR: <mode> OK | +CTZR: 0 OK |
| Test | AT+CTZR=? | +CTZR: (list of supported <mode>s) OK | +CTZR: (0-1) OK |
| URC | | +CTZV: <tz>[,<time>] | +CTZV: +04,"12/12/31,23:46:33" |
| URC | | +CTZE: <tz>,<dst>[,<time>] | +CTZE: +04,1,"12/12/31,23:46:33" |
| URC | | +CTZEU: <tz>,<dst>[,<utime>] | +CTZEU: +04,1 |
| URC | | +CTZDST: <dst> | +CTZDST: 1 |

5.10.3 Defined values

| Parameter | Type | Description |
|-----------|--------|---|
| <mode> | Number | Enables the time zone reporting URCs: <ul style="list-style-type: none"> • 0: disable the time zone change event reporting • 1: enable the time zone reporting by +CTZV and +CTZDST URCs • 2: enable the time zone reporting by +CTZE URC • 3: enable the time zone reporting and universal time reporting by +CTZEU URC according with 3GPP TS 27.007 Release 13 Allowed values: <ul style="list-style-type: none"> • SARA-R4 / SARA-N4 - 0 (default value), 1. The +CTZDST URC is not supported. |
| <tz> | Number | Indicates the time zone. The range goes from -48 to +56. |
| <time> | String | Current local time in format "yy/MM/dd,hh:mm:ss". The characters indicate year, month, day, hour, minutes, seconds. |
| <dst> | Number | Indicates the daylight saving time. The allowed values are: <ul style="list-style-type: none"> • 0: no adjustments • 1: +1 hour adjustment • 2: +2 hours adjustment |
| <utime> | String | Universal time in format "yyyy/MM/dd,hh:mm:ss". The characters indicate year, month, day, hour, minutes, seconds. |

5.10.4 Notes

- The **+CTZU** AT command (automatic time zone setting) does not affect the time zone reporting.
- The time zone information is expressed in steps of 15 minutes.
- The reported <tz> reflects the <dst> offset: if time zone is +1 hour and the daylight saving time is +1 hour, the reported <tz> is +08.

- For the +CTZE URC, the local time <time> needs to be derived by the MT.

SARA-R4 / SARA-N4

- The command setting is not stored in the NVM.
- The <time> parameter is not supported.

5.11 Report mobile termination error +CMEE

| +CMEE | | | | | | |
|-------------------|---------------|---------------------|-----------------------|-----------------------|----------------------|----------------------------|
| Modules | All products | | | | | |
| Attributes | Syntax | PIN required | Settings saved | Can be aborted | Response time | Error reference |
| | full | No | No | No | - | +CME Error |

5.11.1 Description

Configures the formatting of the result code +CME ERROR: <err> as an indication of an error relating to the functionality of the MT. When enabled, MT related errors cause +CME ERROR: <err> final result code instead of the regular ERROR final result code. The error result code is returned normally when an error is related to syntax, invalid parameters or MT functionality.

5.11.2 Syntax

| Type | Syntax | Response | Example |
|------|---------------|---------------------------------------|--------------------|
| Set | AT+CMEE=[<n>] | OK | AT+CMEE=2 OK |
| Read | AT+CMEE? | +CMEE: <n> OK | +CMEE: 0 OK |
| Test | AT+CMEE=? | +CMEE: (list of supported <n>s) OK | +CMEE: (0-2) OK |

5.11.3 Defined values

| Parameter | Type | Description |
|-----------|--------|--|
| <n> | Number | <ul style="list-style-type: none"> • 0: +CME ERROR: <err> result code disabled and ERROR used • 1: +CME ERROR: <err> result code enabled and numeric <err> values used • 2: +CME ERROR: <err> result code enabled and verbose <err> values used |

5.11.4 Notes

- The following convention is valid:

| Numeric error code | Verbose error code | Description |
|--------------------|---------------------------|---|
| 3 | "operation not allowed" | The MT is in a state which does not allow performing the entered command. |
| 4 | "operation not supported" | The error result code is related to a parameter not covered by the GSM/ETSI or u-blox specification |

6 Call control

6.1 Dial command D

| D | | | | | | |
|-------------------|---------------|---------------------|-----------------------|-----------------------|----------------------|------------------------|
| Modules | SARA-R4 | | | | | |
| Attributes | Syntax | PIN required | Settings saved | Can be aborted | Response time | Error reference |
| | full | Yes | No | Yes | Up to 3 min | +CME Error |

6.1.1 Description

Lists characters that may be used in a dialling string for making a call (voice, data or fax call) or controlling supplementary services in accordance with 3GPP TS 22.030 [60] and initiates the indicated kind of call. No further commands may follow in the command line in case of data or fax calls.

- SARA-R4
Voice calls are not supported.
Set the DTR line to ON state before making a data call.

6.1.2 Syntax

| Type | Syntax | Response | Example |
|--------|--------------------------|----------------------------------|---|
| Action | ATD<number>[<I>][<G>][:] | See Result codes | Voice call ATD123456; OK <hr/> Data / fax call ATD123456 CONNECT 9600 <hr/> Supplementary services ATD*#43# +CCWA: 0,1 +CCWA: 0,2 OK |

6.1.3 Defined values

| Parameter | Type | Description |
|-----------|--------|---|
| <number> | Number | Dial string; the allowed characters are: 1 2 3 4 5 6 7 8 9 0 * # + A B C D , T P ! W @ (see the 3GPP TS 27.007 [58]). The following characters are ignored: , T ! W @. The first occurrence of P is interpreted as pause and separator between the dialling number and the DTMF string. The following occurrences are interpreted only as pause. The use of P as pause has been introduced for AT&T certification. |
| <I> | String | Set the CLI status; the allowed values are: <ul style="list-style-type: none"> • I (ASCII code 49 Hex): CLI presentation restricted • i: CLI presentation allowed The CLIR supplementary service subscription is overridden for this call. |
| <G> | String | Configures the CUG supplementary service for the specific call: <ul style="list-style-type: none"> • G: CUG activated • g: CUG deactivated |

6.1.4 Notes

SARA-R4

- This command is abortable.

6.2 Call answer A

| A | | | | | | |
|-------------------|----------------------------------|---------------------|-----------------------|-----------------------|----------------------|------------------------|
| Modules | SARA-R404M SARA-R410M SARA-R412M | | | | | |
| Attributes | Syntax | PIN required | Settings saved | Can be aborted | Response time | Error reference |
| | full | No | No | No | < 20 s | +CME Error |

6.2.1 Description

Instructs the DCE to immediately connect to the line and start the answer sequence as specified for the underlying DCE. Any additional command that appears after A on the same command line is ignored. The command is abortable.



SARA-R4

The user is informed that an incoming call is waiting, by the RING IRC.

6.2.2 Syntax

| Type | Syntax | Response | Example |
|--------|--------|----------|---------|
| Action | ATA | RING | |
| | | OK | |

6.2.3 Notes

SARA-R4

- This command is abortable.

6.3 Hook control H

| H | | | | | | |
|-------------------|-----------------------------------|---------------------|-----------------------|-----------------------|----------------------|------------------------|
| Modules | SARA-R422 SARA-R422M8S SARA-R422S | | | | | |
| Attributes | Syntax | PIN required | Settings saved | Can be aborted | Response time | Error reference |
| | full | No | No | No | < 20 s | +CME Error |

6.3.1 Description

Disconnects the remote user. In case of multiple calls, all the active calls and held calls are released while the waiting calls are not.



In case of dual service calls, the command will switch the call from data (if different from fax) to voice.



SARA-R422 / SARA-R422M8S / SARA-R422S

Issue the `AT+CVHU=0` command in order to make ATH over Online Command Mode (OLCM) work, according to 3GPP requirements. If the module has a DUN/PPP activated and is in OLCM, the command deactivates the PPP and the associated PDP context (if possible).

6.3.2 Syntax

| Type | Syntax | Response | Example |
|--------|--------|----------|---------|
| Action | ATH | OK | |

6.4 Voice hangup control +CVHU

| +CVHU | | | | | | |
|-------------------|-----------------------------------|---------------------|-----------------------|-----------------------|----------------------|------------------------|
| Modules | SARA-R422 SARA-R422M8S SARA-R422S | | | | | |
| Attributes | Syntax | PIN required | Settings saved | Can be aborted | Response time | Error reference |
| | full | No | No | No | - | +CME Error |

6.4.1 Description

Sets whether issuing the ATH command or an ON-to-OFF transition on the DTR line causes a voice connection, including alternating mode calls that are currently in voice mode, to be disconnected or not.

6.4.2 Syntax

| Type | Syntax | Response | Example |
|------|------------------|--|--------------------|
| Set | AT+CVHU=[<mode>] | OK | AT+CVHU=0 OK |
| Read | AT+CVHU? | +CVHU: <mode> OK | +CVHU: 1 OK |
| Test | AT+CVHU=? | +CVHU: (list of supported <mode>s) OK | +CVHU: (0-1) OK |

6.4.3 Defined values

| Parameter | Type | Description |
|-----------|--------|---|
| <mode> | Number | Allowed values: <ul style="list-style-type: none"> 0: the ON-to-OFF transition on the DTR line is ignored, but the "OK" final result code is issued. The ATH command disconnects the remote user. 1 (default value): both the ON-to-OFF transition on the DTR line and the ATH command are ignored, but the "OK" final result code is issued. |

7 Network service

7.1 Network parameters definition

| Parameter | Type | Description | Commands |
|-------------------|--------|---|---------------------------------------|
| <MCC> | Number | Mobile Country Code. The range is 0-999 (3 digits). <ul style="list-style-type: none"> SARA-R4 - The FFF value is to be considered not known or not detectable | +COPS, +UCGED, +UCFSCAN |
| <MNC> | Number | Mobile Network Code. The range is 0-999 (1 to 3 digits). <ul style="list-style-type: none"> SARA-R4 - the FFF value is to be considered not known or not detectable | +COPS, +UCGED, +UCFSCAN |
| <LAC> | Number | Location Area Code, The range is 0x0-0xFFFF (2 octets) | +COPS, +UCFSCAN |
| <CI> | Number | Cell identity. <ul style="list-style-type: none"> SARA-R4 - The range is: <ul style="list-style-type: none"> 2G cell: range 0x0-0xFFFF (2 octets) 4G cell: range 0x0-0xFFFFFFFF (28 bits), 000 0000 if not known or not detectable. | +COPS, +UCFSCAN |
| <RxLev> | Number | Received Signal Strength Indicator (RSSI) index as defined in 3GPP TS 45.008 [73]: <ul style="list-style-type: none"> 0: less than -110 dBm 1..62: from -110 to less than -48 dBm with 1 dBm steps 63: -48 dBm or greater | +COPS, +UCGED, +UCFSCAN |
| <RAC> | Number | Routing Area Code, range 0h-FFh (1 octet); see the 3GPP TS 44.018 [144] | +COPS |
| <t_adv> | Number | Timing Advance, it is valid during a connection and it will updated during the next connection; see the 3GPP TS 04.18 [84]. The special value -1 means not valid. | +UCGED |
| <scrambling_code> | Number | Scrambling code. | +COPS, +UCGED |
| <dl_frequency> | Number | Downlink frequency. The range is 0-16383. | +COPS |
| <ul_frequency> | Number | Uplink frequency. The range is 0-16383. | +COPS |
| <arfcn> | Number | Absolute Radio Frequency Channel Number (ARFCN). <ul style="list-style-type: none"> SARA-R4 - The range is 0-1023, 65535 if not known or not detectable. | +COPS, +UCGED, +UCFSCAN |
| <rscp_lev> | Number | Received Signal Code Power expressed in dBm levels: <ul style="list-style-type: none"> 0: less than -115 dBm 1..90: from -115 dBm to less than -25 dBm with 1 dBm steps 91: -25 dBm | +COPS |
| <ecn0_lev> | Number | Energy per Chip/Noise ratio expressed in dB levels: <ul style="list-style-type: none"> 0: less than -24 dB 1..48: from -24 dB to less than 0 dB with 0.5 dB steps 49: 0 dB | +COPS, +UCGED |
| <EARFCN> | Number | E-UTRAN Absolute radio frequency channel number as defined in the 3GPP TS 36.101 [110]. As per 3GPP TS 36.101 [110] the allowed values depend on the module supported bands. See the corresponding module data sheet for the complete list of the bands supported by each module. <ul style="list-style-type: none"> SARA-R4 / SARA-N4 - Special value 65535 means not known or not detectable | +UCGED, +VZWRSPR, +VZWRSPRQ, +UCFSCAN |
| <PhysCellID> | Number | Physical cell ID. The range is 0-503. | +COPS, +UCFSCAN |

| Parameter | Type | Description | Commands |
|--------------------------------|--------|---|-------------------------|
| <TAC> | Number | Tracking area code. <ul style="list-style-type: none"> SARA-R4 - The range is 0-0xFFFF (2 octets), FFFF if not known or not detectable | +COPS, +UCGED, +UCFSCAN |
| <LcellId> | Number | E-UTRAN CI (cell identifier) in hexadecimal format; the range is 0h-FFFFFFFh (28 bits), 0000000 if not known or not detectable. | +UCGED |
| <dI_EARFCN> | Number | Downlink E-UTRAN absolute radio frequency channel number in decimal format. | +COPS |
| <uI_EARFCN> | Number | Uplink E-UTRAN absolute radio frequency channel number in decimal format. | +COPS |
| <RSRP> | Number | Reference Signal Received Power (RSRP) as defined in 3GPP TS 36.133 [115]: <ul style="list-style-type: none"> 0: less than -140 dBm 1..96: from -140 dBm to less than -44 dBm with 1 dBm steps 97: -44 dBm or greater SARA-R4 / SARA-N4 - The value 255 is return if not known or not detectable | +COPS, +UCGED, +UCFSCAN |
| <RSRQ> | Number | | +COPS, +UCGED |
| <RSRP_value> | Number | Current Reference Signal Received Power (RSRP) expressed in dBm, the range goes from -140.00 dBm to -44.00 dBm. | +UCGED, +UCFSCAN |
| <RSRQ_value> | Number | Current Reference Signal Received Quality (RSRQ) expressed in dB, the range goes from -20.00 dB to -3.00 dB. | +UCGED, +UCFSCAN |
| <BSIC> | Number | Base Station Identify Code (BSIC) in hexadecimal format, the range is 0x0-0x3F (6 bits). | +COPS, +UCGED, +UCFSCAN |
| <Lband> | Number | E-UTRAN band (see 3GPP TS 36.101 Table 5.5-1 [110]). Allowed values: <ul style="list-style-type: none"> SARA-R4 - From 0 to 44, 255 if not known or not detectable | +UCGED |
| <Requested_eDRX_cycle> | String | Requested eDRX cycle value to be allocated to the UE. Half byte in a 4 bit format: the eDRX cycle value refers to bit 4 to 1 of octet 3 of the extended DRX parameters information element. For the coding and the value range, see the extended DRX parameters information element in 3GPP TS 24.008 table 10.5.5.32/3GPP TS 24.008 [67]. <ul style="list-style-type: none"> SARA-R422 / SARA-R422M8S / SARA-R422S - The factory-programmed value is 11 ("1011"). SARA-R410M-02B / SARA-R410M-52B / SARA-R410M-63B / SARA-R410M-73B / SARA-R410M-83B / SARA-R412M - For the factory-programmed value, see Mobile Network Operator profiles. | +CEDRXS, +CEDRXRDP |
| <Assigned_eDRX_cycle> | String | Assigned eDRX cycle value. Half byte in a 4 bit format: the eDRX cycle value refers to bit 4 to 1 of octet 3 of the extended DRX parameters information element. For the coding and the value range, see the extended DRX parameters information element in 3GPP TS 24.008 table 10.5.5.32/3GPP TS 24.008 [67]. | +CEDRXS, +CEDRXRDP |
| <Requested_paging_time_window> | String | Requested paging time window value to be allocated to the UE. Half byte in a 4 bit format: the paging time window (PTW) refers to bit 8 to 5 of octet 3 of the extended DRX parameters information element. For the coding and the value range, see the extended DRX parameters information element in 3GPP TS 24.008 table 10.5.5.32/3GPP TS 24.008 [67]. <ul style="list-style-type: none"> SARA-R422 / SARA-R422M8S / SARA-R422S - The factory-programmed value is 3 ("0011"). | +CEDRXS |

| Parameter | Type | Description | Commands |
|-------------------------------|--------|---|-------------------|
| | | <ul style="list-style-type: none"> SARA-R410M-02B / SARA-R410M-52B / SARA-R410M-63B / SARA-R410M-73B / SARA-R410M-83B / SARA-R412M - For the factory-programmed value, see Mobile Network Operator profiles. | |
| <Assigned_paging_time_window> | String | Assigned paging time window value. Half byte in a 4 bit format: the paging time window (PTW) refers to bit 8 to 5 of octet 3 of the extended DRX parameters information element. For the coding and the value range, see the extended DRX parameters information element in 3GPP TS 24.008 table 10.5.5.32/3GPP TS 24.008 [67]. | +CEDRXS, +CEDRXDP |
| <LTE_rrc> | Number | LTE radio resource control (RRC) state: <ul style="list-style-type: none"> 0: null 1: IDLE 2: ATTEMPT TO CONNECT 3: CONNECTED 4: LEAVING CONNECTED STATE 5: ATTEMPT LEAVING E-UTRA 6: ATTEMPT ENTERING E-UTRA 255: not known or not detectable | +UCGED |

7.2 Subscriber number +CNUM

| +CNUM | | | | | | |
|------------|--------------|--------------|----------------|----------------|---------------|-----------------|
| Modules | All products | | | | | |
| Attributes | Syntax | PIN required | Settings saved | Can be aborted | Response time | Error reference |
| | full | Yes | No | No | < 10 s | +CME Error |

7.2.1 Description

Returns the MSISDNs related to this subscriber. If the subscriber has different MSISDN for different services, each MSISDN is returned in a separate line.

MSISDN is read from the SIM.

7.2.2 Syntax

| Type | Syntax | Response | Example |
|--------|-----------|--|---|
| Action | AT+CNUM | +CNUM: [<alpha1>],<number1>,<type1> [+CNUM: [<alpha2>],<number2>,<type2> [...] | +CNUM: "Mario Rossi",+39320821708",145 +CNUM: "ABCD . AAA", "123456789012",129 OK |
| Test | AT+CNUM=? | OK | |

7.2.3 Defined values

| Parameter | Type | Description |
|-----------|--------|--|
| <alpha> | String | Associated with <number> |
| <number> | String | Phone number of format specified by <typex> |
| <typex> | Number | Type of address, octet in Number format (145 when <number> string includes '+', otherwise 129) |

7.3 Signal quality +CSQ

| +CSQ | | | | | | |
|------------|--------------|--------------|----------------|----------------|---------------|-----------------|
| Modules | All products | | | | | |
| Attributes | Syntax | PIN required | Settings saved | Can be aborted | Response time | Error reference |
| | full | No | No | No | - | +CME Error |

7.3.1 Description

Returns the radio signal strength <signal_power> and <qual> from the MT.



SARA-R4 / SARA-N4

The radio signal strength <signal_power> will be also used to build and display the indicator "signal" i.e. signal quality in the information text response of +CIND and in the +CIEV URC (see the +CMER command description).

In dedicated mode, during the radio channel reconfiguration (e.g. handover), invalid measurements may be returned for a short transitory because the MT must compute them on the newly assigned channel.

7.3.2 Syntax

| Type | Syntax | Response | Example |
|--------|----------|---|--------------------------------|
| Action | AT+CSQ | +CSQ: <signal_power>,<qual> OK | +CSQ: 2,5 OK |
| Test | AT+CSQ=? | +CSQ: (list of supported <signal_power>s),(list of supported <qual>s) OK | +CSQ: (0-31,99),(0-7,99) OK |

7.3.3 Defined values

| Parameter | Type | Description |
|----------------|--------|---|
| <signal_power> | Number | The allowed range is 0-31 and 99. Remapped indication of the following parameters: <ul style="list-style-type: none"> the Received Signal Strength Indication (RSSI) in GSM and LTE RATs. For more details on the RSSI values mapping in LTE RAT, see Notes. the Received Signal Code Power (RSCP) in UMTS RAT. When the RF power level of the received signal is the highest possible, the value 31 is reported. When it is not known, not detectable or currently not available, 99 is returned. |
| <qual> | Number | The allowed range is 0-7 and 99. The information provided depends on the selected RAT: <ul style="list-style-type: none"> In 2G RAT CS dedicated and GPRS packet transfer mode indicates the Bit Error Rate (BER) as specified in 3GPP TS 45.008 [138] In 2G RAT EGPRS packet transfer mode indicates the Mean Bit Error Probability (BEP) of a radio block. 3GPP TS 45.008 [138] specifies the range 0-31 for the Mean BEP which is mapped to the range 0-7 of <qual> In UMTS RAT indicates the Energy per Chip/Noise (ECNO) ratio in dB levels of the current cell. 3GPP TS 25.133 [116] specifies the range 0-49 for EcN0 which is mapped to the range 0-7 of <qual> In LTE RAT indicates the Reference Signal Received Quality (RSRQ). TS 36.133 [115] specifies the range 0-34 for RSRQ which is mapped to the range 0-7 of <qual> See Table 3 for the complete parameter mapping. |

7.3.4 Notes

| <qual> | 2G RAT CS and GPRS | 2G RAT EGPRS | UMTS RAT | LTE RAT |
|--------|--------------------|----------------------|---------------------|---------------------|
| 0 | BER < 0.2% | 28 <= MEAN_BEP <= 31 | ECNO_LEV >= 44 | RSRQ_LEV < 5 |
| 1 | 0.2% < BER < 0.4% | 24 <= MEAN_BEP <= 27 | 38 <= ECNO_LEV < 44 | 5 <= RSRQ_LEV < 10 |
| 2 | 0.4% < BER < 0.8% | 20 <= MEAN_BEP <= 23 | 32 <= ECNO_LEV < 38 | 10 <= RSRQ_LEV < 14 |
| 3 | 0.8% < BER < 1.6% | 16 <= MEAN_BEP <= 19 | 26 <= ECNO_LEV < 32 | 14 <= RSRQ_LEV < 18 |
| 4 | 1.6% < BER < 3.2% | 12 <= MEAN_BEP <= 15 | 20 <= ECNO_LEV < 26 | 18 <= RSRQ_LEV < 22 |
| 5 | 3.2% < BER < 6.4% | 8 <= MEAN_BEP <= 11 | 14 <= ECNO_LEV < 20 | 22 <= RSRQ_LEV < 26 |
| 6 | 6.4% < BER < 12.8% | 4 <= MEAN_BEP <= 7 | 8 <= ECNO_LEV < 14 | 26 <= RSRQ_LEV < 30 |

| <qual> | 2G RAT CS and GPRS | 2G RAT EGPRS | UMTS RAT | LTE RAT |
|--------|-----------------------------|--------------------|--------------|----------------|
| 7 | BER > 12.8% | 0 <= MEAN_BEP <= 3 | ECNO_LEV < 8 | RSRQ_LEV >= 30 |
| 99 | Not known or not detectable | | | |

Table 3: <qual> parameter mapping for each supported RAT
SARA-R4 / SARA-N4

- [Table 4](#) maps <signal_power> values reported from UE and the RSSI. RSSI includes the signal transmitted by the network plus noise.

| <signal_power> | RSSI |
|----------------|--|
| 0 | RSSI of the network <= -113 dBm |
| 1 | -111 dBm |
| 2...30 | -109 dBm <= RSSI of the network <= -53 dBm |
| 31 | -51 dBm <= RSSI of the network |
| 99 | Not known or not detectable |

Table 4: Mapping between <signal_power> reported from UE and the RSSI
SARA-R404M / SARA-R410M / SARA-R412M / SARA-N4

- The <qual> parameter is not supported, and will be always set to 99.

SARA-R404M / SARA-R410M / SARA-N4

- Only LTE RAT is supported.

7.4 Extended signal quality +CESQ

| +CESQ | | | | | | |
|------------|--------------|--------------|----------------|----------------|---------------|----------------------------|
| Modules | All products | | | | | |
| Attributes | Syntax | PIN required | Settings saved | Can be aborted | Response time | Error reference |
| | full | No | No | No | - | +CME Error |

7.4.1 Description

Returns the received signal quality and level:

- If the current serving cell is not a GERAN cell, the <rxlev> and <ber> parameters are set to value 99
- If the current serving cell is not a UTRA FDD cell, the <rscp> and the <ecn0> parameters are set to 255
- If the current serving cell is not an E-UTRA cell, the <rsrq> and <rsrp> parameters are set to 255.



The Reference Signal Received Power (RSRP) is a LTE specific measure that averages the power received on the subcarriers carrying the reference signal. The RSRP measurement bandwidth is equivalent to a single LTE subcarrier: its value is therefore much lower than the total received power usually referred to as RSSI. In LTE the RSSI depends on the currently allocated bandwidth, which is not pre-determined. Therefore the RSSI is not useful to describe the signal level in the cell.

7.4.2 Syntax

| Type | Syntax | Response | Example |
|--------|-----------|--|---|
| Action | AT+CESQ | +CESQ: <rxlev>,<ber>,<rscp>,<ecn0> >,<rsrq>,<rsrp> OK | +CESQ: 99,99,255,255,20,80 OK |
| Test | AT+CESQ=? | +CESQ: (list of supported <rxlev>s), (list of supported <ber>s),(list of supported <rscp>s),(list of supported <ecn0>s),(list of supported <rsrq>s),(list of supported <rsrp>s) OK | +CESQ: (0-63,99),(0-7,99),(0-96, 255),(0-49,255),(0-34,255),(0-97, 255) OK |

7.4.3 Defined values

| Parameter | Type | Description |
|-----------|--------|---|
| <rxlev> | Number | Received Signal Strength Indication (RSSI). <ul style="list-style-type: none"> SARA-R4 / SARA-N4 - The allowed values are: <ul style="list-style-type: none"> 0: less than -110 dBm 1..62: from -110 to -49 dBm with 1 dBm steps 63: -48 dBm or greater 99: not known or not detectable |
| <ber> | Number | Bit Error Rate (BER): <ul style="list-style-type: none"> 0..7: as RXQUAL values in the table in 3GPP TS 45.008 [138], subclause 8.2.4 99: not known or not detectable |
| <rscp> | Number | Received Signal Code Power (RSCP): <ul style="list-style-type: none"> 0: less than -120 dBm 1..95: from -120 dBm to -26 dBm with 1 dBm steps 96: -25 dBm or greater 255: not known or not detectable |
| <ecno> | Number | Ratio of received energy per PN chip to the total received power spectral density (see 3GPP TS 25.133 [116] subclause): <ul style="list-style-type: none"> 0: less than -24 dB 1..48: from -24 dB to -0.5 dBm with 0.5 dB steps (i.e. 1: -24 dB <= Ec/Io < -23.5 dB) 49: 0 dB or greater 255: not known or not detectable |
| <rsrq> | Number | Reference Signal Received Quality (RSRQ): <ul style="list-style-type: none"> 0: less than -19.5 dB 1..33: from -19.5 dB to -3.5 dB with 0.5 dB steps 34: -3 dB or greater 255: not known or not detectable |
| <rsrp> | Number | Reference Signal Received Power (RSRP): <ul style="list-style-type: none"> 0: less than -140 dBm 1..96: from -140 dBm to -45 dBm with 1 dBm steps 97: -44 dBm or greater 255: not known or not detectable |

7.5 Operator selection +COPS

| +COPS | | | | | | |
|------------|--------------|--------------|-------------------------|----------------|-----------------------------|----------------------------|
| Modules | All products | | | | | |
| Attributes | Syntax | PIN required | Settings saved | Can be aborted | Response time | Error reference |
| | partial | No | Profile | Yes | Up to 3 min | +CME Error |

7.5.1 Description

Forces an attempt to select and register with the GSM/LTE network operator, that can be chosen in the list of network operators returned by the test command, that triggers a PLMN scan on all supported bands. Through <mode> parameter the network selection can automatically be performed or forced by this command: the access technology is indicated in <AcT> parameter.



In manual PLMN selection mode, if the optional <AcT> parameter is not specified, the modules will select the default access technology with the following priority order: LTE Cat M1, NB-IoT and GSM (not supported technologies will be ignored).



u-blox cellular modules are certified according to all the capabilities and options stated in the Protocol Implementation Conformance Statement document (PICS) of the module. The PICS, according to 3GPP TS 51.010-2 [100], 3GPP TS 34.121-2 [101], 3GPP TS 36.521-2 [122] and 3GPP TS 36.523-2 [123], is a statement of the implemented and supported capabilities and options of a device. If the user changes the command settings during the certification process, the PICS of the application device integrating a u-blox cellular module must be changed accordingly.

To be able to exploit all command functionalities, the SIM card verification is required. The set value can be checked with the read command or by verifying the active profile with [AT&V](#) command if supported (parameter `<format>` is then also visible).

The set command handling depends on the `<mode>` parameter value:

- **<mode>=0 and <mode>=1:** the AT command setting is immediately stored in the current activated profile. If the MT is set in automatic selection mode (`<mode>= 0`), only the mode will be saved. If the MT is set in manual mode (`<mode>= 1`), also the format (`<format>`) and operator (`<oper>`) will be stored.
- **<mode>=4:** the module starts a manual selection of the specified operator; if this operation is not successful, the module will start an automatic network selection and will remain in automatic mode.

If the set command with `<mode>=0` is issued, a further set command with `<mode>=0` is managed as a user reselection (see the 3GPP TS 23.122 [95]), i.e. the module triggers a search for the HPLMN or a higher order PLMN. This is useful when roaming in areas where the HPLMN or a higher order PLMN is available. If no HPLMN or higher order PLMN is found, the module remains in the state it was in prior to the search (e.g. camped and/or registered on the PLMN before the search).

The PLMN search cannot be performed in RRC connected state when the RAT is LTE, hence no PLMN list will be returned at the end of the PLMN scan attempt.



SARA-R410M-02B / SARA-R410M-52B / SARA-R412M / SARA-R422 / SARA-R422M8S / SARA-R422S
If more than one PLMN have the same alphanumeric name in the ROM PLMN name list (see [+COPN](#)), a manual PLMN selection can fail because the device tries to register only on the first PLMN in the ROM list whose alphanumeric code matches the one specified in the [+COPS](#) command.



SARA-R410M / SARA-R412M / SARA-N4
The manual PLMN selection can fail due to the MNO control on the network selection procedure via `EFCSP` setting; for further details see [+PACSP](#).



The user should not enter colliding requests (e.g. `AT+COPS=0` and `AT+COPS=2`) on different communication ports, because this might cause interoperability issues in case overlapping registration and deregistration requests are not handled by the network, and could result in an unpredictable registration state. Similarly, when notified of a GPRS mobile terminated detach event (e.g. via `+CGEV` URC), it is recommended to wait a few seconds before entering `AT+COPS=2` in order to let the pending registration procedure (automatically triggered by the module in most cases) successfully end.



The user should not rely only on the set command "OK" final result code as a confirmation that the network selection has been performed. To determine the current network registration status, [+CEREG](#) should be also checked.

7.5.2 Syntax

| Type | Syntax | Response | Example |
|------|---|---|--|
| Set | <code>AT+COPS=[<mode>[, <format>[,<oper>[, <AcT>]]]]</code> | OK | <code>AT+COPS=0,0</code> OK |
| Read | <code>AT+COPS?</code> | <code>+COPS: <mode>[,<format>,<oper>[, <AcT>]]</code> OK | <code>+COPS: 0,0,"vodafone IT"</code> OK |
| Test | <code>AT+COPS=?</code> | <code>+COPS: [((<stat>, long <oper>, short <oper>, numeric <oper>[,<AcT>])], (<stat>, long <oper>, short <oper>, numeric <oper>[,<AcT>]),[...]]],(list of supported <mode>s),(list of supported <format>s)</code> OK | <code>+COPS: (2,"vodafone IT","voda IT",22210 "),(1,"SI vodafone","vodafone SI",29340 "),(1,"I WIND","I WIND",22288"),(1,"I TIM", "TIM",22201"),(1,"MOBITEL","MOBITEL", "29341"),,(0-4),(0-2)</code> OK |

7.5.3 Defined values

| Parameter | Type | Description |
|---------------------------|--------|---|
| <code><mode></code> | Number | Is used to chose whether the network selection is automatically done by the MT or is forced by this command to the operator <code><oper></code> given in the format <code><format></code> : <ul style="list-style-type: none"> • 0 (default value and factory-programmed value): automatic (<code><oper></code> field is ignored) • 1: manual |

| Parameter | Type | Description |
|-----------|--------|--|
| | | <ul style="list-style-type: none"> • 2: deregister from network • 3: set only <format> • 4: manual/automatic |
| <format> | Number | <ul style="list-style-type: none"> • 0 (factory-programmed value): long alphanumeric <oper> • 1: short format alphanumeric <oper> • 2: numeric <oper> |
| <oper> | String | Given in format <format> this field may be up to 24 characters long for long alphanumeric format, up to 10 characters for short alphanumeric format and 5 or 6 characters long for numeric format (MCC/MNC codes). The factory-programmed value is FFFF (undefined). |
| <stat> | Number | <ul style="list-style-type: none"> • 0: unknown • 1: available • 2: current • 3: forbidden |
| <AcT> | Number | Indicates the radio access technology: <ul style="list-style-type: none"> • 0: GSM • 3: GSM/GPRS with EDGE availability • 7: LTE • 8: EC-GSM-IoT (A/Gb mode) • 9: E-UTRAN (NB-S1 mode) Allowed values: <ul style="list-style-type: none"> • SARA-R404M / SARA-R410M-63B / SARA-R410M-73B - 7 • SARA-R410M-01B - 8, 9 • SARA-R410M-02B / SARA-R410M-52B / SARA-R410M-83B - 7, 9 • SARA-R412M / SARA-R422 / SARA-R422M8S / SARA-R422S - 0, 3, 7, 9 • SARA-N4 - 9 |
| | |  SARA-R410M-02B On SARA-R410M-02B-00 the allowed radio access technology are: 8, 9. |

7.5.4 Notes

SARA-R4 / SARA-N4

- The command setting is not stored in the personal profile.
- The set command is abortable, the test command cannot be aborted in the same line.
- <format> and <oper> parameters are optional only if the <mode> parameter is set to 0, 2 or 3.
- If the antenna is not connected, then the information text response to the test command is: +COPS: ,, (0-4),(0-2)
- If no network is available, the test command returns an error result code.

SARA-R410M-02B

- <AcT>=8 is used for LTE Cat M1 on SARA-R410M-02B-00.

SARA-R410M-01B

- <AcT>=8 is used for LTE Cat M1.

7.6 Radio Access Technology (RAT) selection +URAT

| +URAT | | | | | | |
|------------|--------------|--------------|----------------|----------------|---------------|-----------------|
| Modules | All products | | | | | |
| Attributes | Syntax | PIN required | Settings saved | Can be aborted | Response time | Error reference |
| | partial | No | NVM / OP | No | <10 s | +CME Error |

7.6.1 Description

Allows to select the Radio Access Technologies (RAT) to be activated at next registration cycle and, in case of multi-RAT configuration, defines the RAT priority order.

Depending on how many parameters are specified, it is possible to select single or multi-RAT behaviour. The order of the RAT parameters defines the priority of the related radio access technologies selected at boot or when entering full functionality from deregistered state. The <1stAcT> parameter identifies the RAT to

be selected firstly. If <2ndAcT> parameter is specified, it determines which RAT is selected if no cellular service can be obtained by the module on the <1stAcT>. If <3rdAcT> parameter is specified, it determines the remaining RAT selected when no service can be obtained in the preferred one(s).



SARA-R4 / SARA-N4

Any change in the RAT settings require the reboot of the module via [AT+CFUN=15](#) to make the setting effective.



u-blox cellular modules are certified according to all the capabilities and options stated in the Protocol Implementation Conformance Statement document (PICS) of the module. The PICS, according to 3GPP TS 51.010-2 [100], 3GPP TS 34.121-2 [101], 3GPP TS 36.521-2 [122] and 3GPP TS 36.523-2 [123], is a statement of the implemented and supported capabilities and options of a device. If the user changes the command settings during the certification process, the PICS of the application device integrating a u-blox cellular module must be changed accordingly.



In dual mode and tri mode, due to lack of inter-RAT coordination, only the Access Stratum protocol of the current selected RAT is active.



SARA-R4

Every 60 minutes a periodic PLMN scan is performed whenever the module is attached to the <2ndAcT> (or to the <3rdAcT>); if the current RPLMN is found on the <1stAcT> (or on the <2ndAcT>), the module will select the higher priority RAT and register on it.

7.6.2 Syntax

| Type | Syntax | Response | Example |
|------|--|--|--------------------------------|
| Set | AT+URAT=<1stAcT>[,<2ndAcT>[,<3rdAcT>]] | OK | AT+URAT=7,8 OK |
| Read | AT+URAT? | +URAT: <1stAcT>[,<2ndAcT>[,<3rdAcT>]] OK | +URAT: 7 OK |
| Test | AT+URAT=? | +URAT: (list of the supported <1stAcT>s)[,(list of the supported <2ndAcT>s)[,(list of the supported <3rdAcT>s)]] OK | +URAT: (7-9),(7-9),(7-9) OK |

7.6.3 Defined values

| Parameter | Type | Description |
|-----------|--------|--|
| <1stAcT> | Number | Indicates the single or highest priority RAT enabled and may be: <ul style="list-style-type: none"> • 3: LTE • 7: LTE Cat M1 • 8: NB-IoT • 9: GPRS / eGPRS Allowed values depend on the module series: <ul style="list-style-type: none"> • SARA-R410M-02B / SARA-R410M-52B / SARA-R410M-63B / SARA-R410M-73B / SARA-R410M-83B - 7 (factory-programmed value), 8 • SARA-R412M / SARA-R422 / SARA-R422M8S / SARA-R422S - 7 (factory-programmed value), 8, 9 • SARA-R404M / SARA-R410M-01B - 3 (factory-programmed value) • SARA-N4 - 8 (factory-programmed value) |
| <2ndAcT> | Number | Indicates the second priority RAT enabled and has the same range as <1stAcT>. The factory-programmed value is: <ul style="list-style-type: none"> • SARA-R410M-02B / SARA-R410M-52B / SARA-R410M-83B / SARA-R412M / SARA-R422 / SARA-R422M8S / SARA-R422S - 8 (NB-IoT) • SARA-R410M-63B / SARA-R410M-73B - By factory-programmed configuration the second priority RAT is not defined. • SARA-R404M / SARA-R410M-01B / SARA-N4 - The parameter is not supported. |
| <3rdAcT> | Number | Indicates the third priority RAT enabled and has the same range as <1stAcT>. The factory-programmed value is: <ul style="list-style-type: none"> • SARA-R412M / SARA-R422 / SARA-R422M8S / SARA-R422S - 9 (GPRS / eGPRS) |

| Parameter | Type | Description |
|-----------|------|---|
| | | <ul style="list-style-type: none"> SARA-R404M / SARA-R410M / SARA-N4 - The parameter is not supported. |

7.6.4 Notes

- AT&T's EF_{RAT} mode contains the RAT mode setting, that is the mode that the module shall be set to. Thus this setting may override +URAT's parameters loaded at boot time.

SARA-R4

- <1stAcT>, <2ndAcT>, <3rdAcT>=9 does not support any of the GSM circuit switched services such as voice, fax, CSD, etc.

SARA-R410M-63B / SARA-R410M-73B

- Do not enable the NB-IoT as highest priority RAT (<1stAcT>) or second priority RAT (<2ndAcT>) by means of the set command.

7.7 CloT Configuration - iRAT timer +URATSCAN

| +URATSCAN | | | | | | |
|------------|---|--------------|----------------|----------------|---------------|-----------------|
| Modules | SARA-R410M-02B SARA-R412M SARA-R422 SARA-R422M8S SARA-R422S | | | | | |
| Attributes | Syntax | PIN required | Settings saved | Can be aborted | Response time | Error reference |
| | Full | No | NVM | No | <10 s | +CME Error |

7.7.1 Description

Configures the iRAT (timeout for better radio air technology search) in the CloT configuration.

7.7.2 Syntax

| Type | Syntax | Response | Example |
|------|--------------------------|--|--------------------------|
| Set | AT+URATSCAN=<irat_timer> | OK | AT+URATSCAN=5 OK |
| Read | AT+URATSCAN? | +URATSCAN: <irat_timer> OK | +URATSCAN: 5 OK |
| Test | AT+URATSCAN=? | +URATSCAN: (list of supported <irat_timer>s) OK | +URATSCAN: (5-120) OK |

7.7.3 Defined values

| Parameter | Type | Description |
|--------------|--------|---|
| <irat_timer> | Number | The range goes from 5 to 120 minutes; the default and factory-programmed value is 60 minutes. |

7.7.4 Notes

SARA-R410M-02B / SARA-R412M

- The command is not supported by SARA-R410M-02B-00, SARA-R410M-02B-01, SARA-R410M-02B-02, SARA-R412M-02B-00, SARA-R412M-02B-01, SARA-R412M-02B-02.

7.8 Full cell scan +UCFSCAN

| +UCFSCAN | | | | | | |
|------------|-----------------------------------|--------------|----------------|----------------|---------------|-----------------|
| Modules | SARA-R422 SARA-R422M8S SARA-R422S | | | | | |
| Attributes | Syntax | PIN required | Settings saved | Can be aborted | Response time | Error reference |
| | full | Yes | No | Yes | Up to 3 min | +CME Error |

7.8.1 Description

Performs an extended network search on the provided radio access technology (RAT); the network search is performed on all the supported bands or only on a subset specified by means of the <bitmask_1_64> and <bitmask_65_127> parameters. All the cells detected during the PLMN search are reported at the AT interface:

- **GSM networks:** all the cells found of any visible PLMNs are reported, including the serving cell and those belonging to the neighbour list of the serving cell.
- **LTE Cat M1/NB-IoT networks:** all the cells found are reported, including the serving cell and those belonging to the neighbour list of the serving cell.



If the requested <AcT> is not enabled by means of the +URAT AT command will return error result code.



The set command can be aborted. The scan might take many seconds, depending on the network conditions and the module's current activities.

7.8.2 Syntax

| Type | Syntax | Response | Example |
|------|--|--|--|
| Set | AT+UCFSCAN=<AcT>[,<bitmask_band1_64>[,<bitmask_band65_127>]] | <p>If <AcT>=7 (LTE Cat M1) or 9 (NB-IoT)</p> <p>+UCFSCAN: <AcT>,<EARFCN>,<dl_bandwidth>,<PhysCellID>,<MCC>,<MNC>,<TAC>,<CI>,<cell_barred>,<RSRP_value>,<RSRQ_value>,<RSSI_value></p> <p>[+UCFSCAN: <AcT>,<EARFCN>,<dl_bandwidth>,<PhysCellID>,<MCC>,<MNC>,<TAC>,<CI>,<cell_barred>,<RSRP_value>,<RSRQ_value>,<RSSI_value>]</p> <p>[...]</p> <p>OK</p> <p>If <AcT>=0 (GSM)</p> <p>+UCFSCAN: <AcT>,<arfcn_band>,<BSIC>,<MCC>,<MNC>,<LAC>,<CI>,<cell_barred>,<RxLev>,<grps_supported></p> <p>[+UCFSCAN: <AcT>,<arfcn_band>,<BSIC>,<MCC>,<MNC>,<LAC>,<CI>,<cell_barred>,<RxLev>,<grps_supported>]</p> <p>[...]</p> <p>OK</p> <p>If no cell is found on requested AcT</p> <p>AT+UCFSCAN=?</p> <p>+UCFSCAN: <AcT></p> <p>OK</p> | <p>AT+UCFSCAN=9</p> <p>+UCFSCAN: 9,6152,101,353,222,88,584C,3761E87,0,"-81","-10","-70"</p> <p>+UCFSCAN: 9,6290,101,388,222,01,9095,AB431A1,0,"-114","-24","0"</p> <p>OK</p> <p>AT+UCFSCAN=0</p> <p>+UCFSCAN: 0,50,0,53,222,10,4E54,209,0,50,1</p> <p>+UCFSCAN: 0,49,0,49,222,10,4E54,E3D3,0,50,1</p> <p>OK</p> <p>AT+UCFSCAN=?</p> <p>+UCFSCAN: (0,7,9),18446744073709551615,18446744073709551615</p> <p>OK</p> |
| Test | AT+UCFSCAN=? | <p>+UCFSCAN: (list of supported <AcT>s),18446744073709551615,18446744073709551615</p> <p>OK</p> | <p>+UCFSCAN: (0,7,9),18446744073709551615,18446744073709551615</p> <p>OK</p> |

7.8.3 Defined values

| Parameter | Type | Description |
|------------------|--------|---|
| <AcT> | Number | Indicates the radio access technology. Allowed values: <ul style="list-style-type: none"> • 0: GSM • 7: LTE Cat M1 • 9: NB-IoT |
| <bitmask_1_64> | Number | Depending on the <AcT> parameter values, configures the bitmask for the LTE or GSM bands. When <AcT>=7 (LTE Cat M1) or <AcT>=9 (NB-IoT), it indicates the bandmask for LTE bands 1 through 64. Each bit enables/disables a band for the scan: <ul style="list-style-type: none"> • Bit 0: band 1 • Bit 1: band 2 • Bit 2: band 3 • Bit 3: band 4 • ... • Bit 63: band 64 When <AcT>=2 (GSM), it indicates bandmask for GSM bands 800 / 900 / 1800 / 1900. The following bit enables/disables a band for the scan: <ul style="list-style-type: none"> • Bit 8: DCS 1800 • Bit 9: ESGM 900 • Bit 20: GSM 850 • Bit 22: PCS 1900 The special value 0 enables all the bands for the scan. The default value is 0. |
| <bitmask_65_127> | Number | When <AcT>=7 (LTE Cat M1) or <AcT>=9 (NB-IoT), it indicates the bandmask for LTE bands 65 through 128. Each bit enables/disables a band for the scan: <ul style="list-style-type: none"> • Bit 0: band 65 • Bit 1: band 66 • Bit 2: band 67 • Bit 3: band 68 • .. • Bit 63: band 128 The special value 0 enables all the bands for the scan. The default value is 0. If <AcT>=0 (GSM) the parameter is not supported. |
| <EARFCN> | Number | See <EARFCN>. |
| <dl_bandwidth> | Number | Downlink bandwidth. Allowed values: <ul style="list-style-type: none"> • 6: NB 6 (1.4 MHz) • 15: NB 15 (3 MHz) • 25: NB 25 (5 MHz) • 50: NB 50 (10 MHz) • 75: NB 75 (15 MHz) • 100: NB 100 (20 MHz) • 101: not known |
| <PhysCellID> | Number | See <PhysCellID>. |
| <MCC> | Number | See <MCC>. |
| <MNC> | Number | See <MNC>. |
| <TAC> | Number | See <TAC>. |
| <CI> | Number | See <CI>. |
| <cell_barred> | Number | Allowed values: <ul style="list-style-type: none"> • 0: cell not barred • 1: cell barred |
| <RSRP_value> | Number | See <RSRP_value>. |
| <RSRQ_value> | Number | See <RSRQ_value>. |
| <RSSI_value> | Number | Cell received signal strength indication (RSSI) value in dBm. The range goes from -120 .0 dBm to 0 dBm. |
| <arfcn> | Number | See <arfcn>. |
| <arfcn_band> | Number | Allowed values: <ul style="list-style-type: none"> • 0: EGSM 900 • 1: PGSM 900 • 2: PCS 1900 |

| Parameter | Type | Description |
|------------------|--------|--|
| | | <ul style="list-style-type: none"> • 3: DCS 1800 • 4: 850 |
| <BSIC> | Number | See <BSIC>. |
| <LAC> | Number | See <LAC>. |
| <RxLev> | Number | See <RxLev>. |
| <gprs_supported> | Number | Allowed values: <ul style="list-style-type: none"> • 0: PS not supported • 1: PS supported • 2: not known |

7.8.4 Examples

| Command | Response | Description |
|---------------------|--|--|
| AT+URAT? | +URAT: 7,8,9 OK | Check the radio access technologies module configuration. The module is configured in LTE Cat. M1, NB-IoT and GSM. |
| AT+UCFSCAN=9 | +UCFSCAN: 9,6152,101,353,222,88,584C,3761E87,0,-81,-10,-70 +UCFSCAN: 9,6290,101,388,222,01,9095,AB431A1,0,-114,-24,0 OK | Perform a scan on any NB-IoT band. |
| AT+UCFSCAN=0 | +UCFSCAN: 0,50,0,53,222,10,4E54,209,0,50,1 +UCFSCAN: 0,49,0,49,222,10,4E54,E3D3,0,50,1 +UCFSCAN: 0,20,0,22,222,01,D5BD,43A,0,26,1 +UCFSCAN: 0,107,0,58,222,88,5FC2,0,0,28,1 +UCFSCAN: 0,47,0,51,222,10,4E54,0,0,27,1 +UCFSCAN: 0,15,0,19,222,01,D5BD,43B,0,25,1 +UCFSCAN: 0,104,0,60,222,88,5FC2,FCED,0,22,1 +UCFSCAN: 0,5,0,16,222,01,D5BD,548D,0,23,1 OK | Perform a scan on any GSM band. |
| AT+UCFSCAN=7 | +UCFSCAN: 7 | Perform a scan on any LTE-M band. No result is found. |
| AT+UCFSCAN=9 | | Perform a scan on any NB-IoT band. |
| <input a character> | OK | The scan is aborted. |
| AT+URAT=8 | OK | Allows the module to register only on NB-IoT network at next reboot. |
| AT+CFUN=15 | OK | Reboot the module. |
| AT+URAT? | +URAT: 8 OK | The module is configured in NB-IoT only. |
| AT+UCFSCAN=0 | +CME ERROR: operation not allowed | A scan on a disabled access technology (GSM) is triggered, therefore an error result code is returned. |

7.9 MAC QoS inactivity timer(s) +UMACQOSTMR

| +UMACQOSTMR | | | | | | |
|-------------------|---|---------------------|-----------------------|-----------------------|----------------------|------------------------|
| Modules | SARA-R410M-02B SARA-R412M SARA-R422 SARA-R422M8S SARA-R422S | | | | | |
| Attributes | Syntax | PIN required | Settings saved | Can be aborted | Response time | Error reference |
| | full | No | NVM / OP | No | <10 s | +CME Error |

7.9.1 Description

Sets MAC QoS inactivity timers for LTE Cat M1 and NB-IoT.

- If the corresponding parameter is omitted in the set command, the module applies the most recently set value.
- If the NV file(s) is (are) not present for either timer, then the specific timer(s) is (are) disabled.



If the set command is issued and any of the optional parameters are omitted, the module applies the most recently set values.

7.9.2 Syntax

| Type | Syntax | Response | Example |
|------|---|---|--|
| Set | AT+UMACQOSTMR=[<m1_tmr>], [<nb_tmr>] | OK | AT+UMACQOSTMR=35,60 OK |
| Read | AT+UMACQOSTMR? | +UMACQOSTMR: <m1_tmr>,<nb_tmr> OK | +UMACQOSTMR: 35,60 OK |
| Test | AT+UMACQOSTMR=? | +UMACQOSTMR: (list of supported <m1_tmr>s),(list of supported <nb_tmr>s) OK | +UMACQOSTMR: [(0,10-120)],[(0,10-120)] OK |

7.9.3 Defined values

| Parameter | Type | Description |
|-----------|--------|--|
| <m1_tmr> | Number | Represents the inactivity timer for LTE Cat M1. The range goes from 10 to 120 s, and 0 (zero) for deleting NV file containing value. If NV file is not present, timer will be disabled. For the factory-programmed value, see Mobile Network Operator profiles . |
| <nb_tmr> | Number | Represents the inactivity timer for NB-IoT. The range goes from 10 to 120 s, and 0 (zero) for deleting NV file containing value. If NV file is not present, timer will be disabled. For the factory-programmed value, see Mobile Network Operator profiles . |

7.9.4 Notes

SARA-R410M-02B / SARA-R412M

- The command is not supported by SARA-R410M-02B-00, SARA-R410M-02B-01, SARA-R410M-02B-02, SARA-R412M-02B-00, SARA-R412M-02B-01, or SARA-R412M-02B-02.
- After having set the <m1_tmr> or <nb_tmr> parameters to 0 (to delete the NV file containing the value), the information text response to the read command is -1.

7.10 Preferred PLMN list selection +CPLS

| +CPLS | | | | | | |
|-------------------|-----------------------------------|---------------------|-----------------------|-----------------------|----------------------|------------------------|
| Modules | SARA-R422 SARA-R422M8S SARA-R422S | | | | | |
| Attributes | Syntax | PIN required | Settings saved | Can be aborted | Response time | Error reference |
| | full | No | No | No | - | +CME Error |

7.10.1 Description

Selects one PLMN selector with Access Technology list in the SIM card or active application in the UICC (GSM or USIM), that is used by +CPOL command.

The set command selects a list in the SIM/USIM. The read command returns the selected PLMN selector list from the SIM/USIM.

The test command returns the whole index range supported lists by the SIM/USIM.

7.10.2 Syntax

| Type | Syntax | Response | Example |
|------|----------------|--|--------------------|
| Set | AT+CPLS=<list> | OK | AT+CPLS=1 OK |
| Read | AT+CPLS? | +CPLS: <list> OK | +CPLS: 1 OK |
| Test | AT+CPLS=? | +CPLS: (list of supported <list>s) OK | +CPLS: (0-2) OK |

7.10.3 Defined values

| Parameter | Type | Description |
|-----------|--------|---|
| <list> | Number | <ul style="list-style-type: none"> 0 (factory-programmed and default value): user controlled PLMN selector with Access Technology EF_{PLMNwAcT}, if not found in the SIM/UICC then PLMN preferred list EF_{PLMNsel} (this file is only available in SIM card or GSM application selected in UICC); these files can be read and updated (see the 3GPP TS 31.102 [72]). 1: operator controlled PLMN selector with Access Technology EF_{OPLMNwAcT}; this file can be read only (see the 3GPP TS 31.102 [72]). 2: HPLMN selector with Access Technology EF_{HPLMNwAcT}; this file can be read only (see the 3GPP TS 31.102 [72]). |

7.11 Network registration status +CREG

| +CREG | | | | | | |
|-------------------|---|---------------------|-----------------------|-----------------------|----------------------|------------------------|
| Modules | SARA-R410M-02B SARA-R410M-52B SARA-R410M-63B SARA-R410M-73B SARA-R410M-83B SARA-R412M SARA-R422 SARA-R422M8S SARA-R422S SARA-N4 | | | | | |
| Attributes | Syntax | PIN required | Settings saved | Can be aborted | Response time | Error reference |
| | partial | Yes | No | No | - | +CME Error |

7.11.1 Description

Configures the network registration URC related to CS domain. Depending on the <n> parameter value, a URC can be issued:

- +CREG: <stat> if <n>=1 and there is a change in the MT's circuit switched mode network registration status in GERAN/UTRAN/E-UTRAN.
- +CREG: <stat>[,<lac>,<ci>[,<AcTStatus>]] if <n>=2 and there is a change of the network cell in GERAN/UTRAN/E-UTRAN.
- +CREG: <stat>[,<lac>],[<ci>],[<AcTStatus>],[<cause_type>,<reject_cause>] if <n>=3 and the MT registration status (<stat>) changes. The <cause_type> and the <reject_cause> parameters are returned only if the MT is not registered, but it is currently searching a new operator to register to (<stat>=2) or if the registration is denied (<stat>=3).

The parameters <AcTStatus>, <lac>, <ci> are provided only if available.

The read command provides the same information issued by the URC together with the current value of the <n> parameter. The location information elements <lac>, <ci> and <AcTStatus>, if available, are returned only when <n>=2 or <n>=3 and the MT is registered with the network. The <cause_type>, <reject_cause> parameters are returned only if <n>=3 and the MT is not registered, but it is currently searching a new operator to register to (<stat>=2) or if the registration is denied (<stat>=3).



When <n>=2, in UMTS RAT, unsolicited location information can be received if the network sends the UTRAN INFORMATION MOBILITY message during dedicated connections; in the latter cases the reported <ci> might be not correct because the UE in DCH state cannot read broadcast system information before the change of serving cell. In contrast, in GSM RAT no unsolicited location information is received during a CS connection.

 The DTE application should set a reasonable timer (10 s) when receiving the +CREG: 3 URC, since this might be due to the fact that the LTE registration was rejected (SIM not enabled for LTE RAT, wrong APN during the initial default bearer setup in the EPS attach procedure and other temporary reject causes).

 If the MT also supports GPRS services and/or EPS services in E-UTRAN, the +CGREG / +CEREG set and read command result codes, where supported, apply to the registration status and location information for those services.

7.11.2 Syntax

| Type | Syntax | Response | Example |
|------|---------------|---|------------------------|
| Set | AT+CREG=[<n>] | OK | AT+CREG=1 OK |
| Read | AT+CREG? | +CREG: <n>,<stat>[,<lac>,<ci>[,<AcTStatus>]] OK | +CREG: 0,0 OK |
| Test | AT+CREG=? | +CREG: (list of the supported <n>s) OK | +CREG: (0-2) OK |
| URC | | +CREG: <stat>[,<lac>],[<ci>[,<AcTStatus>]][,<cause_type>,<reject_cause>]] | +CREG: 1,"4E54","44A5" |

7.11.3 Defined values

| Parameter | Type | Description |
|-------------|--------|--|
| <n> | Number | Network registration URC configuration. Allowed values: <ul style="list-style-type: none"> 0 (default value and factory-programmed value): network registration URC disabled 1: network registration URC enabled 2: network registration and location information URC enabled 3: network registration and reject cause URC enabled |
| <stat> | Number | Network registration status. Allowed values: <ul style="list-style-type: none"> 0: not registered, the MT is not currently searching a new operator to register to 1: registered, home network 2: not registered, but the MT is currently searching a new operator to register to 3: registration denied 4: unknown (e.g. out of GERAN/UTRAN/E-UTRAN coverage) 5: registered, roaming 6: registered for "SMS only", home network (applicable only when <AcTStatus> indicates E-UTRAN) 7: registered for "SMS only", roaming (applicable only when <AcTStatus> indicates E-UTRAN) 8: attached for emergency bearer services only (see 3GPP TS 24.008 [67] and 3GPP TS 24.301 [102] that specify the condition when the MS is considered as attached for emergency bearer services) 9: registered for "CSFB not preferred", home network (applicable only when <AcTStatus> indicates E-UTRAN) 10: registered for "CSFB not preferred", roaming (applicable only when <AcTStatus> indicates E-UTRAN) |
| <lac> | String | Two bytes location area code or tracking area code (if <AcTStatus>=7) in hexadecimal format (e.g. "00C3"). The value FFFF means that the current <lac> value is invalid. |
| <ci> | String | From 2 to 4 bytes cell ID in hexadecimal format (e.g. "A13F" or "129080B"). The value FFFFFFFF means that the current <ci> value is invalid. |
| <AcTStatus> | Number | Indicates the radio access technology: <ul style="list-style-type: none"> 0: GSM 1: GSM COMPACT 2: UTRAN 3: GSM/GPRS with EDGE availability 4: UTRAN with HSDPA availability 5: UTRAN with HSUPA availability |

| Parameter | Type | Description |
|----------------|--------|--|
| | | <ul style="list-style-type: none"> 6: UTRAN with HSDPA and HSUPA availability 7: E-UTRAN 8: EC-GSM-IoT (A/Gb mode) 9: E-UTRAN (NB-S1 mode) 255: the current <ActStatus> value is invalid Allowed values: <ul style="list-style-type: none"> SARA-R404M / SARA-R410M-63B / SARA-R410M-73B - 7 SARA-R412M / SARA-R422 / SARA-R422M8S / SARA-R422S - 0, 3, 7, 9 SARA-R410M-02B / SARA-R410M-52B / SARA-R410M-83B - 7, 9 SARA-R410M-01B - 8, 9 SARA-N4 - 9 |
| <cause_type> | Number | <reject_cause> type. Allowed values: <ul style="list-style-type: none"> 0: indicates that <reject_cause> contains an EMM cause value, see 3GPP TS 24.301 [102] Annex A |
| <reject_cause> | Number | Cause of the failed registration. The value is of type as defined by <cause_type> |

7.11.4 Notes

The following is an overview of the values assumed by the <stat> parameter:

- 0: a technical problem could have occurred, the user is requested to intervene. It is still possible to make emergency calls if some network is available. Possible causes:
 - PIN not entered
 - Invalid HPLMN found on the SIM (SIM read error)
 - SIM card not present

The registration is not started

- 1: the MT is registered for circuit-switched services on the HPLMN (or on one of the equivalent HPLMN's, whose list is provided by the SIM)
- 2: the module is searching a network to register on. Possible causes:
 - No network available
 - Available networks have insufficient Rx level
 - HPLMN or allowed PLMN are available but the registration is rejected, e.g. roaming is not allowed in this Location Area

It is still possible to make emergency calls if network coverage is available

- 3: the CS registration failed after a Location Update Reject; possible causes are:
 - Illegal MS
 - Illegal ME
 - IMSI unknown at HLR
 - PLMN not allowed
 - Location area not allowed
 - Roaming not allowed in this location area
 - Network failure
 - Network congestion

It is still possible to make emergency calls if network coverage is available.

If the registration type is manual, then no further attempt is made to search for a new PLMN or register with it. If the registration type is automatic, the MS may look for an allowed PLMN if the rejection cause was roaming restriction. In case of illegal MS /ME, there could be possible problems with either the SIM card or with the ME's identity (IMEI): user intervention may be required

- 4: this value, usually transitory, is returned if the registration state does not belong to any of the following:
 - Normal
 - Limited
 - No service
 - Service detached
 - Service disabled

It may be issued after the failure of a registration procedure, before starting a PLMN search, when <stat>=2.

- 5: the MT is registered for circuit-switched services on a VPLMN, in national or international roaming
- 6: in LTE, the MT is registered only for the SMS circuit-switched service on the HPLMN (or on one of the equivalent HPLMN's)
- 7: in LTE, the MT is registered only for the SMS circuit-switched service on a VPLMN, in national or international roaming
- 8: the MT is attached for emergency bearer services only.
- 9: in LTE, the MT is registered only for the SMS circuit-switched service on the HPLMN (or on one of the equivalent HPLMN's). CS fallback is not supported for voice services, therefore if the device is configured as "voice centric" (see [+CEMODE](#)) and does not support VoLTE, it will disable LTE and reselect 3G or 2G RAT if supported.
- 10: in LTE, the MT is registered only for the SMS circuit-switched service on a VPLMN, in national or international roaming. CS fallback is not supported for voice services, therefore if the device is configured as "voice centric" (see [+CEMODE](#)) and does not support VoLTE, it will disable LTE and reselect 3G or 2G RAT if supported.

SARA-R4 / SARA-N4

- <n>=3 is not supported.
- <stat>=6, 7, 8, 9, 10 are not supported.

SARA-R410M-01B

- <AcTStatus>=8 is used for E-UTRAN (<AcTStatus>=7).

7.12 Preferred operator list +CPOL

| +CPOL | | | | | | |
|------------|-----------------------------------|--------------|----------------|----------------|---------------|-----------------|
| Modules | SARA-R422 SARA-R422M8S SARA-R422S | | | | | |
| Attributes | Syntax | PIN required | Settings saved | Can be aborted | Response time | Error reference |
| | partial | Yes | No | No | < 10 s | +CME Error |

7.12.1 Description

Edits the user preferred list of networks in the active application on the UICC (GSM or USIM) or preferred list of networks in the SIM card.



SARA-R422 / SARA-R422M8S / SARA-R422S

The command accesses the list of preferred PLMNs previously selected by [+CPLS](#), if implemented. If [+CPLS](#) is not implemented the command tries to access EF_{PLMNwAcT} and if this file is not present and a UICC GSM application is selected or a SIM card is used then the EF_{PLMNsel} file is accessed.



SARA-R422 / SARA-R422M8S / SARA-R422S

The set command writes an entry in the selected list. When an entry is added to the preferred operator list, it should have a correspondence in the ROM PLMN names returned by the [+COPN](#) command. If <index> is given but <oper> is left out, the entry is deleted. If only <format> is given, the <oper> format in the read command is changed. The <GSM_Act>, <GSM_Compact_Act>, <UTRAN_Act> and <E-UTRAN_Act> parameters are required when writing user controlled PLMN selector with Access Technology (EF_{PLMNwAcT}).

The read command returns all used entries from the SIM list of preferred PLMNs and the Access Technologies for each PLMN in the list where provided.

If a new PLMN is added in a different format than the one previously set, the <format> parameter always switches to the last used.



SARA-R422 / SARA-R422M8S / SARA-R422S

If in the [+COPN](#) list there are more than one PLMN with the same name in alphanumeric (short or long) format, the numeric format shall be used to add this PLMN <entry> in the preferred operator list; otherwise the result will be unpredictable.

7.12.2 Syntax

| Type | Syntax | Response | Example |
|------|--|----------|----------------------------------|
| Set | AT+CPOL=[<index>],[<format>],[<oper>],[<GSM_Act>],[<GSM_ | OK | AT+CPOL=2,0,"I WIND",1,0,1 OK |

| Type | Syntax | Response | Example |
|------|---|---|--|
| | Compact_AcT>,<UTRAN_AcT>[,<E-UTRAN_AcT>]]]] | | |
| Read | AT+CPOL? | +CPOL: <index1>,<format>,<oper1>[,<GSM_AcT1>,<GSM_Compact_AcT1>,<UTRAN_AcT1>[,<E-UTRAN_AcT1>]] [+CPOL: <index2>,<format>,<oper2>[,<GSM_AcT2>,<GSM_Compact_AcT2>,<UTRAN_AcT2>[,<E-UTRAN_AcT2>]]...] OK | +CPOL: 1,0,"F SFR",1,0,1 +CPOL: 2,0,"TIM I",1,0,1 OK |
| Test | AT+CPOL=? | +CPOL: (list of supported <index>s), (list of supported <format>s) OK | +CPOL: (1-30),(0-2) OK |

7.12.3 Defined values

| Parameter | Type | Description |
|--------------------|--------|--|
| <index> / <indexn> | Number | Represents the order number of operator in the SIM preferred operator list. The parameter range depends on the number of entries in SIM card (i.e. its size), but can be further limited by the module capabilities of the module. |
| <format> | Number | See also +COPS command description: <ul style="list-style-type: none"> • 0: long format alphanumeric <oper> • 1: short format alphanumeric <oper> • 2 (default value): numeric <oper> |
| <oper> / <opern> | String | Format indicated by <format> |
| <GSM_AcT> | Number | GSM access technology. Allowed values: <ul style="list-style-type: none"> • 0: access technology not selected • 1: access technology selected |
| <GSM_Compact_AcT> | Number | GSM compact access technology. Allowed values: <ul style="list-style-type: none"> • 0: access technology not selected • 1: access technology selected |
| <UTRAN_AcT> | Number | UTRA access technology. Allowed values: <ul style="list-style-type: none"> • 0: access technology not selected • 1: access technology selected |
| <E-UTRAN_AcT> | Number | E-UTRAN access technology. Allowed values: <ul style="list-style-type: none"> • 0: access technology not selected • 1: access technology selected |

7.12.4 Notes

SARA-R422 / SARA-R422M8S / SARA-R422S

- In order to rewrite an entry it is needed to delete it first.
- The <UTRAN_AcT> parameter can be set only to value 0 since the 3G RAT (i.e. UTRAN) is not supported by the module.

7.13 Read operator names +COPN

| +COPN | | | | | | |
|------------|--|--------------|----------------|----------------|---------------|-----------------|
| Modules | SARA-R410M-02B SARA-R410M-52B SARA-R412M SARA-R422 SARA-R422M8S SARA-R422S | | | | | |
| Attributes | Syntax | PIN required | Settings saved | Can be aborted | Response time | Error reference |
| | full | Yes | No | No | - | +CME Error |

7.13.1 Description

Returns the list of operator names from the MT. Each operator code <numeric n> that has an alphanumeric equivalent <alpha n> in the MT memory shall be returned.

7.13.2 Syntax

| Type | Syntax | Response | Example |
|--------|-----------|---|---|
| Action | AT+COPN | +COPN: <numeric 1>,<alpha1> [+COPN: <numeric2>,<alpha2> [...]] OK | +COPN: "21901","T-Mobile HR" +COPN: "21910","HR VIP" +COPN: "22201","I TIM" +COPN: "22210","vodafone IT" OK |
| Test | AT+COPN=? | OK | OK |

7.13.3 Defined values

| Parameter | Type | Description |
|-------------|--------|---|
| <numeric n> | String | Operator in numeric format (see +COPS AT command) |
| <alpha n> | String | Operator in long alphanumeric format (see +COPS AT command) |

7.13.4 Notes

SARA-R4

- The command is not supported by SARA-R410M-02B-00, SARA-R410M-02B-01, SARA-R410M-52B-00, SARA-R410M-52B-01, SARA-R412M-02B-00, SARA-R412M-02B-01.

7.14 Steering of Roaming configuration +UDCONF=20

| +UDCONF=20 | | | | | | |
|------------|-----------------------------------|--------------|---------------------|----------------|---------------|----------------------------|
| Modules | SARA-R422 SARA-R422M8S SARA-R422S | | | | | |
| Attributes | Syntax | PIN required | Settings saved | Can be aborted | Response time | Error reference |
| | full | No | NVM | No | - | +CME Error |

7.14.1 Description

Enables / disables the Steering of Roaming feature.

The setting can be changed only when the module is not registered to, and not searching for, a network (i.e. when [+CREG's](#) <stat> is 0). The new setting is saved in NVM and takes place at the next network registration / search.

7.14.2 Syntax

| Type | Syntax | Response | Example |
|------|---------------------------|--------------------------------|-------------------------------------|
| Set | AT+UDCONF=20,<SoR_enable> | OK | AT+UDCONF=20,1 OK |
| Read | AT+UDCONF=20 | +UDCONF: 20,<SoR_enable> OK | AT+UDCONF=20 +UDCONF: 20,1 OK |

7.14.3 Defined values

| Parameter | Type | Description |
|--------------|--------|--|
| <SoR_enable> | Number | Enables / disables the Steering of Roaming feature: <ul style="list-style-type: none"> 0: Steering of Roaming disabled 1 (factory-programmed value): Steering of Roaming enabled 2: Steering of Roaming enabled with automatic switch from manual to automatic PLMN selection mode if the maximum number of registration attempts rejected with cause 17 (Network Failure) has been reached |

7.14.4 Notes

SARA-R422 / SARA-R422M8S / SARA-R422S

- <SoR_enable>=2 is not supported.

7.15 Network selection control +PACSP

| +PACSP | | | | | | |
|-------------------|----------------------------------|---------------------|-----------------------|-----------------------|----------------------|----------------------------|
| Modules | SARA-R410M SARA-R412M SARA-N4 | | | | | |
| Attributes | Syntax | PIN required | Settings saved | Can be aborted | Response time | Error reference |
| | full | Yes | No | No | - | +CME Error |

7.15.1 Description

If the EF_{CSP} (Customer Service Profile) is available the +PACSP URC is provided in the following cases:

- SARA-R4 / SARA-N4 - at the module registration
- SARA-R4 / SARA-N4 - whenever the SIM/USIM issues the REFRESH proactive command related to the EF_{CSP}

For further information, see the AT&T Device Requirements [201].

The EF_{CSP} is available on SIM/USIM cards from AT&T mobile network operator.

7.15.2 Syntax

| Type | Syntax | Response | Example |
|------|-----------|-------------------------|---------------|
| Read | AT+PACSP? | +PACSP<bit_value> OK | +PACSP1 OK |
| URC | | +PACSP<bit_value> | +PACSP0 |

7.15.3 Defined values

| Parameter | Type | Description |
|-------------|--------|--|
| <bit_value> | Number | PLMN mode bit value: <ul style="list-style-type: none"> • 0: automatic network selection is forced (see Notes) • 1: network selection mode unchanged (see Notes) |

7.15.4 Notes

- If EF_{CSP} is available, the PLMN mode bit forces the automatic network registration, according to the +COPS <mode> value which is loaded at boot from the selected profile or from the non volatile memory. The following table explains the behavior:

| Autoregistration <mode> | PLMN mode bit <bit_value> | Autoregistration behavior |
|-------------------------|---------------------------|---|
| 0 | 0 | Automatic network selection |
| 1 | 0 | Automatic network selection |
| 2 | 0 | Disabled |
| 0 | 1 | Automatic network selection |
| 1 | 1 | Manual network selection (search for the PLMN stored in the selected profile) |
| 2 | 1 | Disabled |

SARA-R4 / SARA-N4

- The read command is not supported.

7.16 Integrity check on test networks configuration +UDCONF=81

| +UDCONF=81 | | | | | | |
|-------------------|-----------------------------------|---------------------|-----------------------|-----------------------|----------------------|------------------------|
| Modules | SARA-R422 SARA-R422M8S SARA-R422S | | | | | |
| Attributes | Syntax | PIN required | Settings saved | Can be aborted | Response time | Error reference |
| | partial | No | NVM | No | - | +CME Error |

7.16.1 Description

Configures the integrity check on 3G/4G test networks.

- Integrity check on 3G/4G test networks shall be disabled only when the authentication and integrity are disabled on the 3G/4G test network on which the module will be registered.
- Disabling integrity and security will not affect IMS, thus the command cannot be used when using IMS.
- SARA-R422 / SARA-R422M8S / SARA-R422S
Reboot of the module (e.g. by means of the [AT+CFUN=15/AT+CFUN=16](#) command) to make the change effective.

7.16.2 Syntax

| Type | Syntax | Response | Example |
|------|---|---|---------------------------------------|
| Set | AT+UDCONF=81,<integrity_check_ enabled> | OK | AT+UDCONF=81,0 OK |
| Read | AT+UDCONF=81 | +UDCONF: 81,<integrity_check_ enabled> OK | AT+UDCONF=81 +UDCONF: 81,1 OK |

7.16.3 Defined values

| Parameter | Type | Description |
|--------------------------------|--------|--|
| <integrity_check_ enabled> | Number | Integrity check on 3G/4G test networks configuration. Allowed values: <ul style="list-style-type: none"> • 0: integrity check on test networks disabled (MCC/MNC not available in +COPN set command's response) • 1 (factory-programmed value): integrity check on test networks enabled (MCC/MNC not available in +COPN set command's response) |

7.17 Channel and network environment description +UCGED

| +UCGED | | | | | | |
|-------------------|---|---------------------|-----------------------|-----------------------|----------------------|------------------------|
| Modules | SARA-R410M-02B SARA-R410M-52B SARA-R410M-63B SARA-R410M-73B SARA-R410M-83B SARA-R412M SARA-R422 SARA-R422M8S SARA-R422S SARA-N4 | | | | | |
| Attributes | Syntax | PIN required | Settings saved | Can be aborted | Response time | Error reference |
| | partial | No | No | No | - | +CME Error |

7.17.1 Description

Enables the protocol stack and network environment information collection.

The information text response of the read command reports only the current RAT (if any) parameters, determined by the <rat> parameter value.

- SARA-R410M / SARA-R412M / SARA-N4
The command provides only the information on the serving cell, unless <mode>=2 (short form reporting enabled) and <rat>=2 (2G).
If <mode>=2 (short form reporting enabled) and <rat>=2 (2G), where supported, the module returns also the information on the neighbor cells.

[Table 5](#) lists the supported <mode> parameter values:

| Modules | <mode>=0 | <mode>=2 | <mode>=3 | <mode>=4 | <mode>=5 | <mode>=6 |
|--|----------|----------------|----------|----------|----------|----------|
| SARA-R410M-63B / SARA-R410M-73B / SARA-R410M-83B | * | * | | | * | |
| SARA-R410M-02B / SARA-R412M | * | * ¹ | | | * | |
| SARA-R422 / SARA-R422M8S / SARA-R422S | * | * | | | | |
| SARA-R410M-52B / SARA-N4 | * | | | | * | |

Table 5: <mode> parameter applicability



7.17.2 Syntax

| Type | Syntax | Response | Example |
|------|-----------------|---|--|
| Set | AT+UCGED=<mode> | OK | AT+UCGED=5 OK |
| Read | AT+UCGED? | <mode>=0: +UCGED: MODE_5_DISABLED OK <mode>=2, <rat>=2: +UCGED: 2 2,222,1 <rat>,<MCC>,<MNC> <arfcn>,<band1900>,<GcellId>, <BSIC>,<Glac>,<Grac>,<RxLev>,<t_ N1: 222,1,1023,3a26,16,d5bd,29,23, adv>,<C1>,<C2>,<NMO>,<channel_ 23 type> N2: 222,1,13,5266,17,d5bd,28,22,22 [N1: <MCC>,<MNC>,<arfcn>, <GcellId>,<BSIC>,<Glac>,<RxLev>, <C1>,<C2> [N2: <MCC>,<MNC>,<arfcn>, <GcellId>,<BSIC>,<Glac>,<RxLev>, <C1>,<C2> [...]] OK <mode>=2, <rat>=6 or <rat>=7: +UCGED: 2 +UCGED: 2 6,310,410 <rat>,<MCC>,<MNC> 5110,12,10,10,830e,162,-86,-14,131,-1, <EARFCN>,<Lband>,<ul_BW>, <dl_BW>,<TAC>,<P-CID>,<RSRP_ N1: 310,410,5110,123,-87,-15 value>,<RSRQ_value>,<NBMSinr>, <esm_cause>,<emm_state>,<tx_ N2: 310,410,5110,321,-88,-16 pwr>,<drx_cycle_len>,<tmsi> OK [N1: <MCC>,<MNC>,<EARFCN>,<P- CID>,<RSRP_value>,<RSRQ_value> [N2: <MCC>,<MNC>,<EARFCN>,<P- CID>,<RSRP_value>,<RSRQ_value> [...]] OK <mode>=5: +RSRP: 162,5110,"-075.00", +RSRP: <P-CID>,<EARFCN>, "+RSRP_value", +RSRQ: <P-CID>,<EARFCN>, "+RSRQ_value", OK | +UCGED: MODE_5_DISABLED OK +UCGED: 2 2,222,1 1009,0,5265,11,d5bd,00,36,-1,30,30 ,1,1 N1: 222,1,1023,3a26,16,d5bd,29,23, 23 N2: 222,1,13,5266,17,d5bd,28,22,22 OK OK +UCGED: 2 6,310,410 5110,12,10,10,830e,162,-86,-14,131,-1, 3,255,128,"FB306E02" N1: 310,410,5110,123,-87,-15 N2: 310,410,5110,321,-88,-16 OK OK +RSRP: 162,5110,"-075.00", +RSRQ: 162,5110,"-14.20", OK |

¹ Not supported by SARA-R410M-02B-00, SARA-R410M-02B-01, SARA-R410M-02B-02, SARA-R412M-02B-00, SARA-R412M-02B-01 and SARA-R412M-02B-02

| Type | Syntax | Response | Example |
|------|------------|---|-----------------------|
| | | OK | |
| Test | AT+UCGED=? | +UCGED: (list of supported <mode>s) OK | +UCGED: (0,2,5) OK |

7.17.3 Defined values

| Parameter | Type | Description |
|----------------|--------|---|
| <mode> | Number | Allowed values: <ul style="list-style-type: none"> 0: reporting disabled 2: short form reporting enabled 3: retrieve the short form text information report 4: retrieve the mobility management (MM) transition state 5: RSRP and RSRQ reporting enabled 6: short form reporting with mobility management (MM) transition state enabled |
| <MMtransition> | Number | Mobility management transition state. Allowed values: <ul style="list-style-type: none"> 0: no change 1: handover to UMTS 2: handover to GSM 3: handover to LTE 4: reselection to UMTS 5: reselection to GSM 6: reselection to LTE 7: cell change order to UMTS 8: cell change order to GSM 9: cell change order to LTE 10: RAT change 255: unknown |
| <rat> | Number | Current Radio Access Technology: <ul style="list-style-type: none"> 2: 2G 3: 3G 4: 4G 5: unknown. The parameter is set to a 5 until a network information update is not successfully performed through the AT+UCGED=2 command or when the MT is set to minimum functionality (+CFUN: 4, +CFUN: 19). 6: LTE Cat M1 7: NB-IoT |
| <svc> | Number | Current radio service state: <ul style="list-style-type: none"> 0: not known or not detectable 1: radio off 2: searching 3: no service 4: registered The radio service state is updated at each change from a valid network service state (2G, 3G or 4G) to another valid network service state (2G, 3G or 4G). To retrieve the network registration status information refer to +CREG, +CGREG and +CEREG AT commands. |
| <MCC> | Number | See <MCC>. |
| <MNC> | Number | See <MNC>. |
| <EARFCN> | Number | See <EARFCN>. |
| <Lband> | Number | See <Lband>. |
| <ul_BW> | Number | Number of Uplink Resource Blocks (see 3GPP TS 36.101 table 5.6-1 [110]), 255 if not known or not detectable.  SARA-R4 The parameter indicates the uplink bandwidth and it is expressed in MHz. |
| <dl_BW> | Number | Number of Downlink Resource Blocks (see 3GPP TS 36.101 table 5.6-1 [110]), 255 if not known or not detectable.  SARA-R4 The parameter indicates the downlink bandwidth and it is expressed in MHz. |

| Parameter | Type | Description |
|-----------------|--------|---|
| <TAC> | Number | See <TAC>. |
| <LcellId> | Number | See <LcellId>. |
| <mTmsi> | Number | 4 bytes MME Temporary Mobile Subscriber Identity in hexadecimal format; 00000000 if not known or not detectable. |
| <mmeGrId> | Number | 2 bytes MME Group Identifier in hexadecimal format; FFFF if not known or not detectable. |
| <RSRP> | Number | See <RSRP>. |
| <RSRQ> | Number | See <RSRQ>. |
| <mmeCode> | Number | 1 byte MME Code in hexadecimal format; FF if not known or not detectable. |
| <Lsinr> | Number | E-UTRAN Signal to Interference and Noise ratio in dB. |
| <LTE_rrc> | Number | See <LTE_rrc>. |
| <RI> | Number | Rank Indicator value; 255 if not known or not detectable. It is updated every 480 ms with the value which has been most often reported to the network in the previous 480 ms period. See 3GPP TS 36.213 [129] section 7.2 and 3GPP TS 36.212 [130] section 5.2.2.6 for more details. |
| <CQI> | Number | Channel Quality Indicator value; 255 if not known or not detectable. It is updated every 480 ms with the value which has been most often reported to the network in the previous 480 ms period. See 3GPP TS 36.213 [129] section 7.2 for more details. |
| <avg_rsrp> | Number | Average value of last 10th Reference Signal Received Power (RSRP). |
| <totalPuschPwr> | Number | Mobile output power for PUSCH transmission averaged over 480 ms in dBm. |
| <avgPucchPwr> | Number | Mobile output power for PUCCH transmission averaged over 480 ms in dBm. |
| <drx> | Number | Discontinuous Reception "drx-Inactivity-Timer" value in ms; 0 if not known or not detectable. |
| <l2w> | Number | SIB3 LTE to WCDMA reselection criteria: (threshServingLow)x2 +(q-RxLevMin)x2; 255 if not known or not detectable. |
| <volte_mode> | Number | Reserved for future use. |
| <meas_gap> | Number | Measurement gap configuration: <ul style="list-style-type: none"> • 0: disabled • 40: 40 ms measurement gap repetition period corresponding to the measurement gap pattern ID 0 (see table 8.1.2.1-1 of 3GPP TS 36.133 [115]) • 80: 80 ms measurement gap repetition period corresponding to the measurement gap pattern ID 1 (see table 8.1.2.1-1 of 3GPP TS 36.133 [115]) |
| <tti_bundling> | Number | TTi (Transmission Time interval) bundling status: <ul style="list-style-type: none"> • 0: off • 1: on |
| <NBMSinr> | Number | Logarithmic value of SINR values expressed in 1/5th of a dB. The range goes from 0 to 250 which translates to a range from -20 dB to 30 dB |
| <esm_cause> | Number | ESM cause value as defined in 3GPP TS 24.301 [102] |
| <emm_state> | Number | EMM state value as defined in 3GPP TS 24.301 [102]. Allowed values: <ul style="list-style-type: none"> • 0: EMM-NULL • 1: EMM-DEREGISTERED • 2: EMM-REGISTERED-INITIATED • 3: EMM-REGISTERED • 4: EMM-TRACKING-AREA-UPDATING-INITIATED • 5: EMM-SERVICE-REQUEST-INITIATED • 6: EMM-DEREGISTERED-INITIATED • 7: undefined (or invalid) |
| <tx_pwr> | Number | TX power value in 1/10 dBm if device is in traffic, 255 otherwise |
| <drx_cycle_len> | Number | Idle DRX cycle length in 10 ms radio-frame units |
| <tmsi> | String | TMSI in hexadecimal format, with most significant byte first |
| <P-CID> | Number | E-UTRAN cell Physical Cell ID; the range is 0-503, 65535 if not known or not detectable. |
| <RSRP_value> | Number | See <RSRP_value>. |
| <RSRQ_value> | Number | See <RSRQ_value>. |

7.17.3.1 SARA-R4 2G parameters

| Parameter | Type | Description |
|-----------|--------|--------------|
| <arfcn> | Number | See <arfcn>. |

| Parameter | Type | Description |
|----------------|--------|--|
| <band1900> | Number | Indicates whether the given <arfcn> in the range 512-810 is part of band 1900 or not, to avoid ambiguity between bands 1800 and 1900: <ul style="list-style-type: none"> • 0: the given <arfcn> is not part of band 1900 • 1: the given <arfcn> is part of band 1900 |
| <GcellId> | Number | GERAN Cell Identifier (CI) in hexadecimal format; the range is 0h-FFFFh (2 octets). |
| <BSIC> | Number | See <BSIC>. |
| <Glac> | Number | Two bytes location area of the GERAN cell in hexadecimal format; FFFF if not known or not detectable. |
| <Grac> | Number | One byte routing area of the GERAN cell in hexadecimal format; FF if not known or not detectable. |
| <RxLev> | Number | See <RxLev>. |
| <t_adv> | Number | See <t_adv>. |
| <C1> | Number | Value of c1; see the 3GPP TS 05.08 [73] |
| <C2> | Number | Value of c2; see the 3GPP TS 05.08 [73] |
| <NMO> | Number | Network Mode of Operation (NMO); see the 3GPP TS 03.60 [154]: <ul style="list-style-type: none"> • 0: NMO I • 1: NMO II • 2: NMO III • -1: invalid |
| <channel_type> | Number | Current channel type: <ul style="list-style-type: none"> • 0: traffic channel / packet data traffic channel (TCH/PDTCH) • 1: broadcast control channel (BCCH) |

Table 6: 2G parameters

7.17.4 Notes

SARA-R412M

- Set the command to <mode>=5 only if the module is not registered on 2G RAT.

7.18 Smart jamming detection +UJAD

| +UJAD | | | | | | |
|------------|-----------------------------------|--------------|----------------|----------------|---------------|-----------------|
| Modules | SARA-R422 SARA-R422M8S SARA-R422S | | | | | |
| Attributes | Syntax | PIN required | Settings saved | Can be aborted | Response time | Error reference |
| | partial | Yes | NVM | No | - | +CME Error |

7.18.1 Description

The feature consists of detecting, at the application level, an anomalous source of interference or jammer installed in the cellular network and signalling it to the client. The jamming condition occurs when an interference is detected (i.e. the band scan reveals radio channels with power levels equal to or higher than a predefined threshold and quality levels equal to or higher than a predefined threshold).

The jamming condition is cleared when the above mentioned statement does not hold.

The command automatically sets and adjusts the thresholds for jamming detection based on the environment (number of visible cells and signal levels).

The feature works on a RAT basis; the information text response to the read command provides the jamming detection status for each supported RAT.



The jamming detection feature is always active, the <mode> parameter enables the jamming detection URC. When enabled, an unsolicited indication is issued when the jamming condition is entered or released.

7.18.2 Syntax

| Type | Syntax | Response | Example |
|------|----------------|------------------------------|-----------------|
| Set | AT+UJAD=<mode> | OK | AT+UJAD=1 OK |
| Read | AT+UJAD? | +UJAD: <mode>,<active>,<AcT> | +UJAD: 0,0,0 |

| Type | Syntax | Response | Example |
|------|-----------|--|------------------------------------|
| | | [...] OK | +UJAD: 0,1,7 +UJAD: 0,0,9 OK |
| Test | AT+UJAD=? | +UJAD: (list of supported <mode>s) OK | +UJAD: (0,1) OK |
| URC | | +UJAD: <active>,<AcT> | +UJAD: 1,7 |

7.18.3 Defined values

| Parameter | Type | Description |
|-----------|--------|--|
| <mode> | Number | Enables/disables jamming detection URC. Allowed values: <ul style="list-style-type: none"> 0 (default and factory-programmed value): smart jamming detection URC disabled 1: smart jamming detection URC enabled; the +UJAD URC may be generated |
| <active> | Number | Jamming detection status: <ul style="list-style-type: none"> 0: jamming not detected 1: jamming detected |
| <AcT> | Number | Indicates the radio access technology: <ul style="list-style-type: none"> 0: GSM 7: LTE 9: E-UTRAN (NB-S1 mode) |

7.18.4 Notes

- An error result code is provided when attempting to enable/disable the smart jamming detection when it is already enabled/disabled.

7.19 Edit Verizon wireless APN table +VZWAPNE

| +VZWAPNE | | | | | | |
|------------|--|--------------|----------------|----------------|---------------|-----------------|
| Modules | SARA-R404M SARA-R410M-01B SARA-R410M-02B SARA-R410M-52B SARA-N4 | | | | | |
| Attributes | Syntax | PIN required | Settings saved | Can be aborted | Response time | Error reference |
| | partial | No | NVM | No | - | +CME Error |

7.19.1 Description

Reads and writes the APN table stored in the NVM:

- The set command causes the APN table on the DUT to be overwritten. Only Class 3, 6 and 7 APNs can be overwritten to any customer defined string.
- The read command queries the APN table that is currently on the DUT, starting from the first entry to the last; it returns each APN entry in a new line.

7.19.2 Syntax

| Type | Syntax | Response | Example |
|------|--|--|---|
| Set | AT+VZWAPNE=<wapn>,<apncl>,<apnni>,<apntype>,<apnb>,<apned>,<apntime> | OK | AT+VZWAPNE=1,1,"IMS","IPv6","LTE","Enabled",0 OK |
| Read | AT+VZWAPNE? | [+VZWAPNE: <apncl>,<apnni>,<apntype>,<apnb>,<apned>,<apntime> [...]] OK | +VZWAPNE: 1,"IMS","IPv4v6","LTE","Enabled",0 +VZWAPNE: 2,"VZWADMIN","IPv4v6","LTE","Enabled",0 OK |
| Test | AT+VZWAPNE=? | +VZWAPNE: (list of supported <wapn>s),(list of supported <apncl>s),,(range of supported <apntype>s),range of supported <apnb>s),(list of supported | +VZWAPNE: (0-4),(1-4),("IPv6","IPv4v6"),("LTE"),("Enabled","Disabled"),(0-1023) OK |

| Type | Syntax | Response | Example |
|------|--------|---|---------|
| | | <apned>s),(list of supported <apntime>s) OK | |

7.19.3 Defined values

| Parameter | Type | Description |
|-----------|--------|---|
| <wapn> | Number | APN list entry |
| <apncl> | Number | APN class |
| <apnni> | String | Network identifier: <ul style="list-style-type: none"> "IMS" or "VZWIMS": Verizon IMS PDN, factory-programmed value for <apncl>=1 entry "VZWADMIN": Verizon Administrative PDN, factory-programmed for <apncl>=2 entry "VZWINTERNET": Verizon Internet PDN, factory-programmed for <apncl>=3 entry "VZWAPP": Verizon Application PDN, factory-programmed for <apncl>=4 entry "ENTERPRISE": Verizon Enterprise PDN, factory-programmed for <apncl>=6 entry "THINGSPLACE": Verizon Thingspace PDN, factory-programmed for <apncl>=7 entry |
| <apntype> | String | <ul style="list-style-type: none"> "IPv6": IPv6 type "IPv4v6" (factory-programmed value): IPv4 and IPv6 type |
| <apnb> | String | APN bearer: <ul style="list-style-type: none"> "LTE" (factory-programmed value): LTE bearer used |
| <apned> | String | Enable/disable the APN: <ul style="list-style-type: none"> "Enabled" (factory-programmed value): APN enabled "Disabled": APN disabled |
| <apntime> | Number | APN inactivity timer value in minutes. <ul style="list-style-type: none"> SARA-R4 -The range goes from 0 to 122820. The value '0' (factory-programmed value) sets the timer to infinity. |

7.19.4 Notes

SARA-R4 / SARA-N4

- If the current MNO profile is not set to Verizon (see the [+UMNOPROF](#) AT command, <MNO>=3) and the command is issued, the module returns an error result code.

SARA-R404M

- The class 1 APN NI is "VZWIMS".
- <apncl>=6 is not supported.
- <apncl>=7 is not supported.

7.20 Read RSRP values +VZWRSP

| +VZWRSP | | | | | | |
|-------------------|--|---------------------|-----------------------|-----------------------|----------------------|----------------------------|
| Modules | SARA-R404M SARA-R410M-01B SARA-R410M-02B SARA-R410M-52B SARA-N4 | | | | | |
| Attributes | Syntax | PIN required | Settings saved | Can be aborted | Response time | Error reference |
| | full | No | No | No | - | +CME Error |

7.20.1 Description

Returns the RSRP (Reference Signal Received Power) values for all LTE cells which the module is measuring.

7.20.2 Syntax

| Type | Syntax | Response | Example |
|------|------------|----------|-------------------------------|
| Read | AT+VZWRSP? | +VZWRSP: | +VZWRSP: 000,2175,"-61.00" |

| Type | Syntax | Response | Example |
|------|--------|---|---------|
| | | [<cellID1>,<EARFCN1>,<RSRP1>[,<cellID2>,<EARFCN2>,<RSRP2>[,...]]] | OK |
| | | OK | |

7.20.3 Defined values

| Parameter | Type | Description |
|-----------|--------|--|
| <cellIDn> | Number | nth cell physical cell identifier in "xxx" format. The range goes from 0 to 503. |
| <EARFCNn> | Number | nth cell EARFCN in decimal format, see <EARFCN> . |
| <RSRPn> | String | nth cell RSRP value in dBm/15 kHz where the format is "-XX.XX". |

7.20.4 Notes

SARA-R4 / SARA-N4

- If the current MNO profile is not set to Verizon (see the [+UMNOPROF](#) AT command, <MNO>=3) and the command is issued, the module returns an error result code.

7.21 Read RSRQ values +VZWRSRQ

| +VZWRSRQ | | | | | | |
|-------------------|--|---------------------|-----------------------|-----------------------|----------------------|----------------------------|
| Modules | SARA-R404M SARA-R410M-01B SARA-R410M-02B SARA-R410M-52B SARA-N4 | | | | | |
| Attributes | Syntax | PIN required | Settings saved | Can be aborted | Response time | Error reference |
| | full | No | No | No | - | +CME Error |

7.21.1 Description

Returns the RSRQ (Reference Signal Received Quality) values for all the LTE cells which the module is measuring.

7.21.2 Syntax

| Type | Syntax | Response | Example |
|------|-------------|--|--------------------------------------|
| Read | AT+VZWRSRQ? | +VZWRSRQ: [<cellID1>,<EARFCN1>,<RSRQ1>[,<cellID2>,<EARFCN2>,<RSRQ2>[,...]]] | +VZWRSRQ: 000,2175,"-11.00" OK |
| | | OK | |

7.21.3 Defined values

| Parameter | Type | Description |
|-----------|--------|--|
| <cellID> | Number | nth cell physical cell identifier in "xxx" format. The range goes from 0 to 503. |
| <EARFCNn> | Number | nth cell EARFCN in decimal format, see <EARFCN> . |
| <RSRQn> | String | nth cell RSRQ value in dB/15 kHz where the format is "-XX.XX". |

7.21.4 Notes

SARA-R4 / SARA-N4

- If the current MNO profile is not set to Verizon (see the [+UMNOPROF](#) AT command, <MNO>=3) and the command is issued, the module returns an error result code.

7.22 Signalling connection status +CSCON

| +CSCON | | | | | | |
|-------------------|--|---------------------|-----------------------|-----------------------|----------------------|------------------------|
| Modules | SARA-R410M-02B SARA-R410M-63B SARA-R410M-73B SARA-R410M-83B SARA-R412M SARA-R422 SARA-R422M8S SARA-R422S | | | | | |
| Attributes | Syntax | PIN required | Settings saved | Can be aborted | Response time | Error reference |
| | full | No | NVM | No | - | +CME Error |

7.22.1 Description

Returns details of the current terminal's perceived radio connection status (i.e. to the base-station). The set command configures the +CSCON URC. When enabled, the URC is sent from the MT at each change of the MT connection mode.

The state is only updated when radio events, such as send and receive, take place. This means that the current state may be out of date. The terminal may think it is "Connected" yet cannot currently use a base station due to a change in the link quality.

SARA-R412M
The information text response of the read command returns only the URC configuration (<n>).

7.22.2 Syntax

| Type | Syntax | Response | Example |
|------|--------------|---|---------------------|
| Set | AT+CSCON=<n> | OK | AT+CSCON=1 OK |
| Read | AT+CSCON? | +CSCON: <n>[,<mode>[,<state>[,<access>]]] OK | +CSCON: 1,1 OK |
| Test | AT+CSCON=? | +CSCON: (list of supported <n>s) OK | +CSCON: (0,1) OK |
| URC | | +CSCON: <mode>[,<state>[,<access>]] | +CSCON: 0 |

7.22.3 Defined values

| Parameter | Type | Description |
|-----------|--------|---|
| <n> | Number | URC configuration: <ul style="list-style-type: none"> 0: +CSCON URC disabled 1: URC +CSCON: <mode> enabled 2: URC +CSCON: <mode>[,<state>] enabled 3: URC +CSCON: <mode>[,<state>[,<access>]] enabled Allowed values: <ul style="list-style-type: none"> SARA-R4 - 0 (factory-programmed value), 1 |
| <mode> | Number | Indicates the signaling connection status: <ul style="list-style-type: none"> 0: idle 1: connected |
| <state> | Number | Allowed values: <ul style="list-style-type: none"> 0: UTRAN URA_PCH 1: UTRAN Cell_PCH 2: UTRAN Cell_FACH 3: UTRAN Cell_DCH 4: GERAN CS connected 5: GERAN PS connected 6: GERAN CS and PS connected 7: E-UTRAN connected |
| <access> | Number | Indicates the radio access technology: <ul style="list-style-type: none"> 4: E-UTRAN FDD |

7.22.4 Notes

SARA-R4

- The <state> and <access> parameters are not supported.

SARA-R410M-02B

- The command is not supported by SARA-R410M-02B-00, SARA-R410M-02B-01, SARA-R410M-02B-02.

7.23 Radio Policy Manager (RPM) activation +URPM

| +URPM | | | | | | |
|------------|-----------------------------------|--------------|----------------|----------------|---------------|-----------------|
| Modules | SARA-R422 SARA-R422M8S SARA-R422S | | | | | |
| Attributes | Syntax | PIN required | Settings saved | Can be aborted | Response time | Error reference |
| | full | No | NVM / OP | No | - | +CME Error |

7.23.1 Description

Activates or deactivates the Radio Policy Manager (RPM) feature for SIM cards not belonging to AT&T network operator, where the feature is enabled by default.

Generally a UE can aggressively retry the registration procedure until it is successful and can behave similarly in case the PDP context activation procedure fails. This behaviour may cause signaling overload and consequently prolonged network outage. To avoid these scenarios and provide a more efficient access to the network, the Radio Policy Manager (RPM) feature controls the number of network accesses per service type over a fixed amount of time. For more details on the RPM feature see AT&T Device Requirements [201] and GSMA Connection Efficiency [157].

Some network reject error causes require specific behaviors which the RPM feature does not alter (see the 3GPP TS 24.008 [67]).

7.23.2 Syntax

| Type | Syntax | Response | Example |
|------|----------------|--|--------------------|
| Set | AT+URPM=<mode> | OK | AT+URPM=1 OK |
| Read | AT+URPM? | +URPM: <mode> OK | +URPM: 1 OK |
| Test | AT+URPM=? | +URPM: (list of supported <mode>s) OK | +URPM: (0,1) OK |

7.23.3 Defined values

| Parameter | Type | Description |
|-----------|--------|--|
| <mode> | Number | Indicates the action to perform: <ul style="list-style-type: none"> 0 (factory-programmed value): RPM feature deactivated 1: RPM feature activated The factory-programmed value depends on the series module: <ul style="list-style-type: none"> SARA-R4 - see Mobile Network Operator profiles |

7.23.4 Notes

SARA-R422 / SARA-R422M8S / SARA-R422S

- If enabled by the selected MNO profile factory-programmed configuration (for more details, see [Mobile Network Operator profiles](#)) do not change the RPM algorithm enabling status.

7.24 eDRX setting +CEDRXS

| +CEDRXS | | | | | | |
|-------------------|---|---------------------|-----------------------|-----------------------|----------------------|------------------------|
| Modules | SARA-R410M-02B SARA-R410M-52B SARA-R410M-63B SARA-R410M-73B SARA-R410M-83B SARA-R412M SARA-R422 SARA-R422M8S SARA-R422S SARA-N4 | | | | | |
| Attributes | Syntax | PIN required | Settings saved | Can be aborted | Response time | Error reference |
| | full | Yes | NVM / OP | No | - | +CME Error |

7.24.1 Description

Configures the UEs extended discontinuous reception (eDRX) parameters. The command controls whether the UE wants to apply the eDRX or not, as well as the requested eDRX cycle and paging time window values for each specified type of radio access technology.

The set command also enables the +CEDRXP URC, that is issued on any change in the eDRX parameters, when enabled by the network.

The set command with <mode>=3 will disable the use of eDRX and reset all parameters to factory-programmed values. Optional parameters are not provided in this form of command.

The read command returns the requested eDRX cycle and paging time window values. See the +CEDRXP URC and the +CEDRXRDP AT command to see if eDRX is enabled by the network and retrieve the values assigned by the network.

The parameters are omitted in the information text response to the read command when the eDRX is not enabled on any RAT.

SARA-R4 / SARA-N4
Deregister the module from the network to change the command setting. Issue `AT+COPS=2` or `AT+CFUN=0` to deregister from network, issue the +CEDRXS command and reboot the module (by means of the `AT+CFUN=15` command) in order to apply the +CEDRXS settings.

SARA-R4 / SARA-N4
If the set command is issued and any of the optional parameters is omitted, the module applies the last set values.

7.24.2 Syntax

| Type | Syntax | Response | Example |
|------|---|--|--|
| Set | AT+CEDRXS=[<mode>[,<AcT_type>[,<Requested_eDRX_cycle>[,<Requested_paging_time_window>]]]] | OK | AT+CEDRXS=1,4,"0101","0101" OK |
| Read | AT+CEDRXS=? | +CEDRXS: [<AcT_type>,<Requested_eDRX_cycle>,<Requested_paging_time_window> [...] [+CEDRXS: <AcT_type>,<Requested_eDRX_cycle>,<Requested_paging_time_window>]] OK | +CEDRXS: 4,"0101","0001" OK |
| Test | AT+CEDRXS=? | +CEDRXS: (list of supported <mode>s),(list of supported <AcT_type>s),(list of supported <Requested_eDRX_cycle>s),(list of supported <Requested_paging_time_window>s) OK | +CEDRXS: (0-3),(3,4,5),("0000"- "1111"),("0000"- "1111") OK |
| URC | | +CEDRXP: <AcT_type>[,<Requested_eDRX_cycle>[,<Assigned_eDRX_cycle>[,<Assigned_paging_time_window>]]] | +CEDRXP: 4,"1010","1001","1101" |

7.24.3 Defined values

| Parameter | Type | Description |
|--------------------------------|--------|--|
| <mode> | Number | Indication to disable or enable the use of eDRX in the UE. Allowed values: <ul style="list-style-type: none"> • 0 (default and factory-programmed value): use of eDRX disabled • 1: use of eDRX enabled • 2: enable the use of eDRX and enable the +CEDRXP URC • 3: disable the use of eDRX and reset all other parameters for eDRX to factory-programmed values |
| <AcT_type> | Number | Indicates the type of access technology: <ul style="list-style-type: none"> • 2: GPRS/eGPRS • 4: E-UTRAN (WB-S1 mode) • 5: E-UTRAN (NB-S1 mode) Allowed values: <ul style="list-style-type: none"> • SARA-R410M-02B / SARA-R410M-83B - 4, 5 • SARA-R410M-52B / SARA-R410M-63B / SARA-R410M-73B - 4 • SARA-R412M / SARA-R422 / SARA-R422M8S / SARA-R422S - 2, 4, 5 • SARA-N4 - 5 |
| <Requested_eDRX_cycle> | String | See <Requested_eDRX_cycle> . |
| <Assigned_eDRX_cycle> | String | See <Assigned_eDRX_cycle> . |
| <Requested_paging_time_window> | String | See <Requested_paging_time_window> . |
| <Assigned_paging_time_window> | String | See <Assigned_paging_time_window> . |

7.24.4 Notes

SARA-R4

- The <mode> and <AcT_type> parameters are mandatory in set command.
- The +CEDRXP URC enablement by means of the AT+CEDRXS=2,<AcT_type> commands is not stored in NVM. Issue AT+CEDRXS=2,<AcT_type> to enable the +CEDRXP URC after each power cycle.
- The test command response is +CEDRXS: (0-3),<AcT-type(2-5)>,<Requested_eDRX_value(0-15) in bits>,<Requested_PTW_value(0-15) in bits>.

SARA-R422 / SARA-R422M8S / SARA-R422S

- To reset all the PSM parameters to factory-programmed values, follow the procedure described in the [+UMNOPROF](#) AT command description.

SARA-R410M / SARA-R412M

- <mode>=3 is not supported. To reset all the eDRX parameters to factory-programmed values (see [Mobile Network Operator profiles](#)), follow the procedure described in the [+UMNOPROF](#) AT command description.
- The <Requested_paging_time_window> parameter is not supported in the read command. Use the +CEDRXP URC or the [+CEDRXRDP](#) command to retrieve the <Requested_eDRX_cycle>, the <Assigned_eDRX_cycle_value> and the <Assigned_paging_time_window>.

SARA-R410M-02B / SARA-R412M

- On SARA-R410M-02B-00, SARA-R410M-02B-01, SARA-R410M-02B-02, SARA-R412M-02B-00, SARA-R412M-02B-01, SARA-R412M-02B-02 the <Requested_paging_time_window> parameter cannot be set by means of the set command.

SARA-R410M-52B

- The <Requested_paging_time_window> parameter cannot be set by means of the set command.

SARA-N4

- The <mode> and <AcT_type> parameters are mandatory in set command.
- The +CEDRXP URC enablement by means of the AT+CEDRXS=2,<AcT_type> commands is not stored in NVM. Issue AT+CEDRXS=2,<AcT_type> to enable the +CEDRXP URC after each power cycle.
- <mode>=3 is not supported. To reset all the eDRX parameters to factory-programmed values, follow the procedure described in the [+UMNOPROF](#) AT command description.

- The <Requested_paging_time_window> parameter is not supported in the read command. Use the +CEDRXP URC or the +CEDRXRDP command to retrieve the <Requested_eDRX_cycle>, the <Assigned_eDRX_cycle_value> and the <Assigned_paging_time_window>.
- The <Requested_paging_time_window> parameter cannot be set by means of the set command.
- The test command response is +CEDRXS: (0-3),<AcT-type(2-5)>,<Requested_eDRX_value(0-15) in bits>.

7.25 eDRX read dynamic parameters +CEDRXRDP

| +CEDRXRDP | | | | | | |
|-------------------|---|---------------------|-----------------------|-----------------------|----------------------|------------------------|
| Modules | SARA-R410M-02B SARA-R410M-52B SARA-R410M-63B SARA-R410M-73B SARA-R410M-83B SARA-R412M SARA-R422 SARA-R422M8S SARA-R422S SARA-N4 | | | | | |
| Attributes | Syntax | PIN required | Settings saved | Can be aborted | Response time | Error reference |
| | full | No | No | No | - | +CME Error |

7.25.1 Description

Provides the information if eDRX is enabled by the network or not. If the eDRX is enabled by the network, the command also provides the requested eDRX cycle value to be allocated to the UE (<Requested_eDRX_cycle>), the assigned eDRX cycle value (<Assigned_eDRX_cycle>) and the assigned paging time window value (<Assigned_paging_time_window>) for the latest valid radio access technology (<AcT_type>). If the eDRX is disabled, the +CEDRXRDP: 0 information text response is returned.

7.25.2 Syntax

| Type | Syntax | Response | Example |
|--------|---------------|--|---|
| Action | AT+CEDRXRDP | +CEDRXRDP: <AcT_type>[, <Requested_eDRX_cycle>, <Assigned_eDRX_cycle_value>, <Assigned_paging_time_window>] OK | +CEDRXRDP: 5,"0010","1110","0101" OK |
| Test | AT+CEDRXRDP=? | OK | |

7.25.3 Defined values

| Parameter | Type | Description |
|-------------------------------|--------|--|
| <AcT_type> | Number | Indicates the type of radio access technology: <ul style="list-style-type: none"> • 0: use of eDRX disabled • 2: GSM (A/Gb mode) • 4: E-UTRAN (WB-S1 mode) • 5: E-UTRAN (NB-S1 mode) Allowed values: <ul style="list-style-type: none"> • SARA-R410M-52B / SARA-R410M-63B / SARA-R410M-73B - 0, 4 • SARA-R410M-02B / SARA-R410M-83B - 0, 4, 5 • SARA-R412M / SARA-R422 / SARA-R422M8S / SARA-R422S - 0, 2, 4, 5 • SARA-N4 - 0, 5 |
| <Requested_eDRX_cycle> | String | See <Requested_eDRX_cycle>. |
| <Assigned_eDRX_cycle> | String | See <Assigned_eDRX_cycle>. |
| <Assigned_paging_time_window> | String | See <Assigned_paging_time_window>. |

7.26 Set MNO profile +UMNOPROF

| +UMNOPROF | | | | | | |
|-------------------|---|---------------------|-----------------------|-----------------------|----------------------|------------------------|
| Modules | SARA-R410M-02B SARA-R410M-52B SARA-R410M-63B SARA-R410M-73B SARA-R410M-83B SARA-R412M SARA-R422 SARA-R422M8S SARA-R422S SARA-N4 | | | | | |
| Attributes | Syntax | PIN required | Settings saved | Can be aborted | Response time | Error reference |
| | partial | Yes | NVM | No | - | +CME Error |

7.26.1 Description

Automatically configures the module to be compliant to the requirements of various Mobile Network Operators.

Follow this procedure to properly set up the configuration:

- Deregister the module from the network (perform a `AT+CFUN=0` or `AT+CFUN=4` cycle or issue the `AT+COPS=2` command)
- Issue `AT+UMNOPROF=<MNO>`
- To apply the new configuration reboot the module
 - SARA-R4 / SARA-N4 - by means of the `AT+CFUN=15` AT command. If `<MNO>=1` (SIM ICCID select), reboot the module twice to apply the MNO profile configuration.

After setting a new configuration the module reconfigures the PDP context settings (e.g. APN of the initial EPS bearer).

SARA-R410M-02B / SARA-R410M-52B / SARA-R412M
On SARA-R410M-02B-00, SARA-R410M-52B-00, SARA-R412M-02B-00 and SARA-R412M-02B-01 if `<MNO>=1` (SIM ICCID select), it is not necessary to reboot the module the second time. Immediately after issuing the `AT+CFUN=15` command the proper MNO profile configuration is applied.

SARA-R4 / SARA-N4
Changing the Mobile Network Operator (MNO) profile with the +UMNOPROF AT command overwrites some AT command settings and applies the default MNO profile values. For the list of AT commands affected by +UMNOPROF AT command, see [Mobile Network Operator profiles](#).

Follow this procedure to restore the profile factory-programmed configuration:

- SARA-R410M / SARA-R412M / SARA-N4 - Set a different profile than the current one and then set the profile back to the original. Reboot the module (`AT+CFUN=15`) to make the change effective.
- SARA-R422 / SARA-R422M8S / SARA-R422S - Set the `<MNO>` parameter to the currently selected profile and reboot the module (`AT+CFUN=15`) to make the change effective

SARA-R4 / SARA-N4
The version of the MNO profiles can be displayed by issuing the set command `AT+UMNOPROF=,1` and then the test command. The MNO profile version will be displayed after each profile in the list.

u-blox cellular modules are certified according to all the capabilities and options stated in the Protocol Implementation Conformance Statement document (PICS) of the module. The PICS, according to 3GPP TS 51.010-2 [100], 3GPP TS 34.121-2 [101], 3GPP TS 36.521-2 [122] and 3GPP TS 36.523-2 [123], is a statement of the implemented and supported capabilities and options of a device. If the user changes the command settings during the certification process, the PICS of the application device integrating a u-blox cellular module must be changed accordingly.

7.26.1.1 SIM ICCID selection

If the `<MNO>` parameter is set to 1 (SIM ICCID select), the mobile network operator profile is selected according to the recognized SIM Issuer Identifier Number (IIN). For more details on the recognized SIM IINs ranges, see the SARA-R4 application development guide [16].

SARA-R410M-63B / SARA-R410M-73B
If a SoftBank or a NTT DoCoMo SIM is inserted the mobile network operator profile (`<MNO>`) is automatically set according to the SIM. After that if the mobile network operator profile (`<MNO>`) is modified to not match the SIM, the MT is set to minimum functionality (`+CFUN: 0`); it is not possible to restore the MT to full functionality (`+CFUN: 1`), until the mobile network operator profile is not set according to the SIM.



SARA-R422 / SARA-R422M8S / SARA-R422S

If the <MNO_detected> value does not map to any of the pre-defined MNOs, the configuration applied after the reboot is the global one (<MNO>=90).

7.26.2 Syntax

| Type | Syntax | Response | Example |
|---------|---|--|--|
| Set | AT+UMNOPROF=<MNO>[,<reset>, OK <urc_notification_enabled>] | | AT+UMNOPROF=1,0,1 OK |
| Read | AT+UMNOPROF? | +UMNOPROF: <MNO>[,<MNO_ detected>],<reset>,<urc_ notification_enabled>] OK | +UMNOPROF: 3 OK |
| SARA-R4 | | | |
| Test | AT+UMNOPROF=? | +UMNOPROF: <MNO_1>: supported MNO_1 name <MNO_2>: supported MNO_2 name ... <MNO_n>: supported MNO_n name OK | +UMNOPROF: 0: SW default 1: SIM ICCID select 6: China Telecom 100: Standard Europe 4: Telstra 5: T-Mobile US 19: Vodafone 3: Verizon 31: Deutsche Telekom OK |
| URC | | +UMNOPROF: <MNO>,<MNO_ detected> | +UMNOPROF: 1,2 |

7.26.3 Defined values

| Parameter | Type | Description |
|-----------|--------|--|
| <MNO> | Number | Mobile Network Operator (MNO) profile: <ul style="list-style-type: none"> • 0: undefined / regulatory. For more details, see Notes. • 1: SIM ICCID/IMSI select • 2: AT&T • 3: Verizon • 4: Telstra • 5: T-Mobile US • 6: China Telecom • 8: Sprint • 19: Vodafone • 20: NTT DoCoMo • 21: Telus • 28: SoftBank • 31: Deutsche Telekom • 32: US Cellular • 33: VIVO • 39: SKT • 41: KDDI • 43: Rogers • 44: Claro Brasil • 45: TIM Brasil • 46: Orange France • 90: global • 100: standard Europe |

| Parameter | Type | Description |
|----------------------------|--------|---|
| | | <ul style="list-style-type: none"> 101: standard Europe No-ePCO. The factory-programmed configuration of this profile is the same of the standard Europe profile (<MNO>=100), but the ePCO is disabled. 102: standard JP (global) 198: AT&T 2-4-12. The factory-programmed configuration of this profile is the same of the AT&T profile (<MNO>=2), but the LTE band 5 is disabled. 199: Generic voice capable AT&T 201: GCF-PTCRB. This profile is meant only for conformance testing. 206: FirstNet <p>Allowed values depend on the module series:</p> <ul style="list-style-type: none"> SARA-R422/SARA-R422M8S/SARA-R422S - 1, 19, 31, 46, 90 (factory-programmed value), 100, 201 SARA-R410M-63B - 0, 1, 20, 28 (factory-programmed value), 102 SARA-R410M-73B - 0, 1, 39 (factory-programmed value) SARA-R410M-83B - 0, 1, 4 (factory-programmed value), 100, 101 SARA-R412M - 0 (factory-programmed value), 1, 2, 19, 31, 33, 44, 45, 46, 100, 101, 198 SARA-R410M-52B - 0 (factory-programmed value), 1, 2, 3, 198 SARA-R410M-02B - 0 (factory-programmed value), 1, 2, 3, 4, 8, 19, 21, 31, 33, 43, 44, 45, 46, 100, 101, 198, 206 SARA-N4 - 0 (factory-programmed value), 1, 2, 3, 4, 5, 6, 21 <p> SARA-R410M-73B On SARA-R410M-73B-00 the allowed Mobile Network Operator (MNO) profiles are: 0, 1, 20, 28, 39 (factory-programmed value).</p> <p> SARA-R410M-63B On SARA-R410M-63B-00 the allowed Mobile Network Operator (MNO) profiles are: 0, 1, 20, 28 (factory-programmed value), 39.</p> <p> SARA-R412M On SARA-R412M-02B-02 the allowed Mobile Network Operator (MNO) profiles are: 0 (factory-programmed value), 1, 19, 31, 100, 101. On SARA-R412M-02B-01 the allowed Mobile Network Operator (MNO) profiles are: 0 (factory-programmed value), 1, 2, 5, 19, 31, 100. On SARA-R412M-02B-00 the allowed Mobile Network Operator (MNO) profiles are: 0 (factory-programmed value), 1, 19, 31, 100.</p> <p> SARA-R410M-52B On SARA-R410M-52B-00, SARA-R410M-52B-01 the allowed Mobile Network Operator (MNO) profiles are: 0 (factory-programmed value), 1, 2, 3.</p> <p> SARA-R410M-02B On SARA-R410M-02B-02 the allowed Mobile Network Operator (MNO) profiles are: 0 (factory-programmed value), 1, 2, 3, 19, 21, 31, 100, 101, 198. On SARA-R410M-02B-01 the allowed Mobile Network Operator (MNO) profiles are: 0 (factory-programmed value), 1, 2, 3, 4, 5, 6, 8, 19, 21, 31, 100. On SARA-R410M-02B-00 the allowed Mobile Network Operator (MNO) profiles are: 0 (factory-programmed value), 1, 2, 3, 4, 5, 6.</p> |
| <MNO_detected> | Number | <p>If <MNO>=1 (SIM ICCID/IMSI select) and the SIM is inserted, it specifies the <MNO> value that matches the SIM Issuer Identifier Number (IIN) or the <MNO> retrieved by the IMSI and that is actually applied.</p> <p> SARA-R4 If the SIM is not inserted or the SIM IIN does not match any <MNO>, the last valid <MNO> remains active and is consequently shown.</p> |
| <reset> | Number | <p>Configure the automatic reset. Allowed values:</p> <ul style="list-style-type: none"> 0: the automatic reset is disabled; the user shall reboot the module by itself 1: the automatic reset is enabled <p>It must be issued only if <MNO>=1.</p> |
| <urc_notification_enabled> | Number | <p>Configure the URC notification. Allowed values:</p> <ul style="list-style-type: none"> 0: URC is not issued if the <MNO_detected> value changes 1: URC is issued any time the <MNO_detected> value changes <p>It must be issued only if <MNO>=1.</p> |

7.26.4 Notes

- The standard Europe profile should be used as the basis for all other MNOs in Europe outside of Vodafone and Deutsche Telekom. However, there may be changes that need to be applied to the module for proper operation with any given European MNO such as attach type, RAT preference, band selection, etc. Please consult with the preferred network provider.

SARA-R422 / SARA-R422M8S / SARA-R422S

- The PIN insertion is not mandatory before the command execution.
- The <reset>, <urc_notification_enabled> parameters are not supported.

SARA-R410M / SARA-R412M / SARA-N4

- If <MNO>=0 the profile selected is undefined.
- The <reset>, <urc_notification_enabled> parameters are not supported.

SARA-R410M-02B / SARA-R410M-52B / SARA-R412M

- The <MNO_detected> parameter is not supported.

7.27 Band selection bitmask +UBANDMASK

| +UBANDMASK | | | | | | |
|-------------------|---|---------------------|-----------------------|-----------------------|----------------------|------------------------|
| Modules | SARA-R410M-02B SARA-R410M-52B SARA-R410M-63B SARA-R410M-73B SARA-R410M-83B SARA-R412M SARA-R422 SARA-R422M8S SARA-R422S SARA-N4 | | | | | |
| Attributes | Syntax | PIN required | Settings saved | Can be aborted | Response time | Error reference |
| | full | Yes | NVM / OP | No | - | +CME Error |

7.27.1 Description

Sets the supported LTE-M / NB-IoT / GSM bands for different Radio Access Technologies (RATs). The LTE bands supported are set by means of bitmasks where each bit in an 64 bit integer corresponds to a LTE-M / NB-IoT band. The GSM bands supported are set by means of a bitmask where specific bits correspond to 850 / 900 / 1800 / 1900 bands.

- SARA-R4 / SARA-N4
Reboot the module ([AT+CFUN=15](#)) to make the setting effective.
- u-blox cellular modules are certified according to all the capabilities and options stated in the Protocol Implementation Conformance Statement document (PICS) of the module. The PICS, according to 3GPP TS 51.010-2 [100], 3GPP TS 34.121-2 [101], 3GPP TS 36.521-2 [122] and 3GPP TS 36.523-2 [123], is a statement of the implemented and supported capabilities and options of a device. If the user changes the command settings during the certification process, the PICS of the application device integrating a u-blox cellular module must be changed accordingly.
- See the corresponding module data sheet for the bands supported by each module.
- SARA-R410M-02B / SARA-R410M-52B / SARA-R410M-63B / SARA-R410M-73B / SARA-R410M-83B / SARA-R412M / SARA-R422 / SARA-R422M8S / SARA-R422S
In compliance with GCF/PTCRB certification and/or mobile network operator specifications, this command may be disabled for certain mobile network operator profiles. For more details, see [+UMNOPROF](#) AT command.

7.27.2 Syntax

| Type | Syntax | Response | Example |
|------|--|--|---|
| Set | AT+UBANDMASK=<RAT>,<bitmask1>[,<bitmask2>] | OK | AT+UBANDMASK=0,2074 OK |
| Read | AT+UBANDMASK? | +UBANDMASK: <RAT>,<bitmask1>[,<bitmask2>][,<RAT>,<bitmask1>[,<bitmask2>][,<RAT>,<bitmask1>]] OK | +UBANDMASK: 0,168761503,1,168761503 OK |

| Type | Syntax | Response | Example |
|------|----------------|---|---|
| Test | AT+UBANDMASK=? | +UBANDMASK: (list of the supported <RAT>s),<bitmask1>, <bitmask2> OK | +UBANDMASK: (0-1),0 xxxxxxxxxxxxxxxx,0xxxxxxxxxxxxxxxx OK |

7.27.3 Defined values

| Parameter | Type | Description |
|------------|--------|--|
| <RAT> | Number | <p>Indicates the Radio Access Technology (RAT):</p> <ul style="list-style-type: none"> 0: LTE Cat M1 1: NB-IoT 2: GSM <p>Allowed values:</p> <ul style="list-style-type: none"> SARA-R422 / SARA-R422M8S / SARA-R422S - 0, 1, 2 SARA-R410M-02B / SARA-R410M-83B / SARA-R412M - 0, 1 SARA-R410M-52B / SARA-R410M-63B / SARA-R410M-73B - 0 |
| <bitmask1> | Number | <p>Depending on the <RAT> parameter value, configures the bitmask for LTE or GSM bands. When <RAT>=0 (LTE Cat M1) or <RAT>=1 (NB-IoT), it indicates the bandmask for LTE bands 1 through 64. Each bit enables/disables a band:</p> <ul style="list-style-type: none"> Bit 0: band 1 Bit 1: band 2 Bit 2: band 3 Bit 3: band 4 .. Bit 63: band 64 <p>The factory-programmed value for LTE-M bands is:</p> <ul style="list-style-type: none"> SARA-R4 - see Mobile Network Operator profiles SARA-N4 - 275063445663 (bands 1,2,3,4,5,8,12,13,17,18,19,20,25,26,28 and 39) <p>The factory-programmed value for NB-IoT bands is:</p> <ul style="list-style-type: none"> SARA-R4 - see Mobile Network Operator profiles SARA-N4 - 185538719 (bands 1,2,3,4,5,8,12,13,17,18,19,20,25,26 and 28) <p>When <RAT>=2 (GSM), it indicates bandmask for GSM bands 800 / 900 / 1800 / 1900. The following bit enables/disables a band:</p> <ul style="list-style-type: none"> Bit 7: DCS 1800 Bit 8: ESGM 900 Bit 19: GSM 850 Bit 21: PCS 1900 <p>If any other bit of the bitmask is set to 1, the module return an error result code is issued.</p> |
| <bitmask2> | Number | <p>When <RAT>=0 (LTE Cat M1) or <RAT>=1 (NB-IoT), it indicates the bandmask for LTE bands 65 through 128. Each bit enables/disables a band:</p> <ul style="list-style-type: none"> Bit 0: band 65 Bit 1: band 66 Bit 2: band 67 Bit 3: band 68 .. Bit 63: band 128 <p>The default value is 0 (all bands from 65 to 128 disabled). If <RAT>=2 (GSM) the parameter is not supported.</p> |

7.27.4 Notes

SARA-R422 / SARA-R422M8S / SARA-R422S



- The read command always returns the <bitmask2> parameters for <RAT>=0 (LTE Cat M1) and <RAT>=1 (NB-IoT).
- The test command response is in decimal integer format (as it is the read command response and input parameters configured by the set command), e.g. +UBANDMASK: (0-2),18446744073709551615,18446744073709551615

7.28 Device service domain configuration +USVCDOMAIN

| +USVCDOMAIN | | | | | | |
|-------------------|--|---------------------|-----------------------|-----------------------|----------------------|------------------------|
| Modules | SARA-R410M-02B SARA-R410M-52B SARA-R410M-63B SARA-R410M-73B SARA-R410M-83B SARA-R412M SARA-R422 SARA-R422M8S SARA-R422S | | | | | |
| Attributes | Syntax | PIN required | Settings saved | Can be aborted | Response time | Error reference |
| | full | Yes | NVM / OP | No | - | +CME Error |

7.28.1 Description

Configures the service domain (CS/PS) upon network attach.

-  Setting the Mobile Network Operator (MNO) profile with the +UMNOPROF AT command will overwrite this setting.
-  Reboot the module in order to apply the new settings.

7.28.2 Syntax

| Type | Syntax | Response | Example |
|------|---|---|--------------------------------------|
| Set | AT+USVCDOMAIN=<domain>[,<voice_domain_preference>[,<ue_usage_setting>]] | OK | AT+USVCDOMAIN=2 OK |
| Read | AT+USVCDOMAIN? | +USVCDOMAIN: <domain>[,<voice_domain_preference>[,<ue_usage_setting>]] OK | +USVCDOMAIN: 2,1,1 OK |
| Test | AT+USVCDOMAIN=? | +USVCDOMAIN: (list of supported <domain>s),(list of supported <voice_domain_preference>s),(list of supported <ue_usage_setting>s) OK | +USVCDOMAIN: (0-2),(0-1),(0-1) OK |

7.28.3 Defined values

| Parameter | Type | Description |
|---------------------------|--------|--|
| <domain> | Number | Service domain: <ul style="list-style-type: none"> • 0: CS only • 1: PS only • 2 (factory-programmed value): CS/PS combined Allowed values: <ul style="list-style-type: none"> • SARA-R4 - 0, 1, 2 |
| <voice_domain_preference> | Number | Voice domain preference IE configuration. The parameter setting is ignored if <domain>=0. Allowed values: <ul style="list-style-type: none"> • 0 (factory-programmed value): IE not present • 1: PS only |
| <ue_usage_setting> | Number | Voice domain preference UE usage setting configuration. The parameter setting is ignored if <domain>=0 or if <voice_domain_preference>=0. Allowed values: <ul style="list-style-type: none"> • 0: voice centric • 1 (factory-programmed value): data centric |

7.28.4 Notes

SARA-R422 / SARA-R422M8S / SARA-R422S

- On NB-IoT RAT, if +UCFGCIOT: 2,1 ("SMS only" enabled) the UE sends an EPS only attach request to the network even if <domain>=2.

SARA-R410M / SARA-R412M

- The PIN insertion is not mandatory before the command execution.

SARA-R412M

- The <voice_domain_preference> and <ue_usage_setting> parameters are not supported by SARA-R412M-02B-00, SARA-R412M-02B-01, SARA-R412M-02B-02.

SARA-R410M-02B

- The command is not supported by SARA-R410M-02B-00.
- The <voice_domain_preference> and <ue_usage_setting> parameters are not supported by SARA-R410M-02B-01, SARA-R410M-02B-02.

SARA-R410M-52B

- The <voice_domain_preference> and <ue_usage_setting> parameters are not supported.

7.29 CloT capabilities configuration +UCFGCIOT

| +UCFGCIOT | | | | | | |
|-------------------|-----------------------------------|---------------------|-----------------------|-----------------------|----------------------|------------------------|
| Modules | SARA-R422 SARA-R422M8S SARA-R422S | | | | | |
| Attributes | Syntax | PIN required | Settings saved | Can be aborted | Response time | Error reference |
| | full | No | NVM / OP | No | - | +CME Error |

7.29.1 Description

Configures and queries several cellular IoT (CloT) EPS capabilities the UE indicates as supported in the ATTACH and TRACKING AREA UPDATE request. If the <param> parameter is omitted in the set command, the device returns the queried <op_code> configuration.

For the factory-programmed values, see [Mobile Network Operator profiles](#).

7.29.2 Syntax

| Type | Syntax | Response | Example |
|------|----------------------------------|---|--------------------------------|
| Set | AT+UCFGCIOT=<op_code>[, <param>] | [+UCFGCIOT: <param>] OK | AT+UCFGCIOT=1,0 OK |
| Test | AT+UCFGCIOT=? | +UCFGCIOT: (list of supported <op_code>s) OK | +UCFGCIOT: (0,1,2,3,4,5) OK |

7.29.3 Defined values

| Parameter | Type | Description |
|-----------|--------|---|
| <op_code> | Number | Cellular IoT (CloT) EPS capabilities to configure. Allowed values: <ul style="list-style-type: none"> 0: S1U data support 1: HC-CPCIOT 2: SMS only 3: ePCO 4: CE restriction 5: CP data backoff timer |
| <param> | Number | Enables / disables cellular IoT (CloT) EPS capabilities depending on <op_code> value: <ul style="list-style-type: none"> 0: disabled 1: enabled |

7.30 CloT optimization configuration +CCIOTOPT

| +CCIOTOPT | | | | | | |
|------------|--|--------------|----------------|----------------|---------------|-----------------|
| Modules | SARA-R410M-63B SARA-R410M-73B SARA-R410M-83B SARA-R422 SARA-R422M8S SARA-R422S | | | | | |
| Attributes | Syntax | PIN required | Settings saved | Can be aborted | Response time | Error reference |
| | full | No | NVM / OP | No | - | +CME Error |

7.30.1 Description

Configures and queries which Cellular IoT (CloT) EPS optimizations the UE indicates as supported and preferred in the ATTACH and TRACKING AREA UPDATE requests. The command also allows reporting of the CloT EPS optimizations that are supported by the network.

The set command enables the +CCIOTOPTI URC, that is issued to indicate the supported CloT EPS optimizations by the network.



SARA-R4

The command impacts only the NB-IoT RAT functionality.

When enabled, the +CCIOTOPTI URC is issued if the network support for CloT EPS optimizations has been changed to previous URC sent. The URC is also issued when activating the indication with AT+CCIOTOPT=1, given that a valid value has been provisioned by the network.



SARA-R4

In compliance with GCF/PTCRB certification and/or mobile network operator specifications, this command may be disabled for certain mobile network operator profiles. For more details, see [+UMNOPROF](#) AT command.



SARA-R422 / SARA-R422M8S / SARA-R422S

For more details on the CloT EPS capabilities, see the [+UCFGCIOT](#) AT command.



SARA-R410M-63B / SARA-R410M-73B

Since NB-IoT RAT is not supported, the command is not effective.

7.30.2 Syntax

| Type | Syntax | Response | Example |
|------|---|---|--------------------------------------|
| Set | AT+CCIOTOPT=<n>[,<supported_UE_opt>[,<preferred_UE_opt>]] | OK | AT+CCIOTOPT=1,2,1 OK |
| Read | AT+CCIOTOPT? | +CCIOTOPT: <n>,<supported_UE_opt>,<preferred_UE_opt> OK | +CCIOTOPT: 0,3,1 OK |
| Test | AT+CCIOTOPT=? | +CCIOTOPT: (list of supported <n>s),(list of supported <supported_UE_opt>s),(list of supported <preferred_UE_opt>s) OK | +CCIOTOPT: (0,1,3),(0-3),(0-2) OK |
| URC | | +CCIOTOPTI: <supported_Network_opt> +CCIOTOPTI: 1 | |

7.30.3 Defined values

| Parameter | Type | Description |
|--------------------|--------|---|
| <n> | Number | Enables or disables reporting of the +CCIOTOPTI URC. <ul style="list-style-type: none"> 0: disable reporting 1: enable reporting 3: disable reporting and reset the parameters for CloT EPS optimization to the factory-programmed values Allowed values: <ul style="list-style-type: none"> SARA-R4 - 0 (default value), 1 |
| <supported_UE_opt> | Number | Indicates the UE's support for CloT EPS optimizations: <ul style="list-style-type: none"> 0: no support. Neither control plane nor user plane optimizations are supported 1: support for control plane CloT EPS optimization |

| Parameter | Type | Description |
|-------------------------|--------|--|
| | | <ul style="list-style-type: none"> • 2: support for user plane CloT EPS optimization • 3 (factory-programmed value): support for both control plane CloT EPS optimization and user plane CloT EPS optimization Allowed values: <ul style="list-style-type: none"> • SARA-R410M - 1, 3 (factory-programmed value). Since NB-IoT must support CP, if the parameter is set to 0 or 2, the module returns an error result code. • SARA-R422 / SARA-R422M8S / SARA-R422S - 1, 3. Since NB-IoT must support CP, if the parameter is set to 0 or 2, the module returns an error result code. For the factory-programmed value, see Mobile Network Operator profiles. |
| <preferred_UE_opt> | Number | Indicates the UE's preference for CloT EPS optimizations. Allowed values: <ul style="list-style-type: none"> • 0: no preference • 1: preference for control plane CloT EPS optimization • 2: preference for user plane CloT EPS optimization (it takes effect only if the support for user plane CloT is configured) • SARA-R410M - The factory-programmed value is 1. • SARA-R422 / SARA-R422M8S / SARA-R422S - For the factory-programmed value, see Mobile Network Operator profiles.  SARA-R4 The <preferred_UE_opt> parameter cannot be set in contrast to the <supported_UE_opt> parameter. If an inconsistent configuration is provided, then the module returns an error result code. |
| <supported_Network_opt> | Number | Indicates the network support for CloT EPS optimizations. Allowed values: <ul style="list-style-type: none"> • 0: no support • 1: support for control plane CloT EPS optimization • 2: support for user plane CloT EPS optimization • 3: support for both control plane CloT EPS optimization and user plane CloT EPS optimization |

7.30.4 Notes

SARA-R4

- The <n> parameter is not stored in NVM.
- If <preferred_UE_opt>=0 (no preference), the UE's preference is for control plane CloT EPS optimization.
- If the network assigns the control plane CloT EPS optimization to the module, a maximum of two contexts can be activated on the NB-IoT radio access technology by means of the **+CGACT** or **+UPSD** AT commands. The limit is not applied if the network assigns the user plane CloT EPS optimization to the module.

7.31 NB-IoT band scan tuning +UDCONF=77

| +UDCONF=77 | | | | | | |
|------------|--|--------------|----------------|----------------|---------------|-----------------|
| Modules | SARA-R410M-02B SARA-R410M-83B SARA-R412M SARA-R422 SARA-R422M8S SARA-R422S | | | | | |
| Attributes | Syntax | PIN required | Settings saved | Can be aborted | Response time | Error reference |
| | full | No | NVM | No | - | +CME Error |

7.31.1 Description

Configures the algorithm used for the scan when in NB-IoT RAT, allowing an optimized scan procedure in terms of time and power consumption.

7.31.2 Syntax

| Type | Syntax | Response | Example |
|------|---------------------------|--------------------------------|-------------------------------------|
| Set | AT+UDCONF=77,<scan_scope> | OK | AT+UDCONF=77,1 OK |
| Read | AT+UDCONF=77 | +UDCONF: 77,<scan_scope> OK | AT+UDCONF=77 +UDCONF: 77,2 OK |

7.31.3 Defined values

| Parameter | Type | Description |
|--------------|--------|--|
| <scan_scope> | Number | <p>Configures the NB-IoT band scan SNR level restriction. The band scan is performed in 3 different levels:</p> <ul style="list-style-type: none"> • "level 0": good SNR • "level 1": medium SNR • "level 2": poor SNR <p>At the power-on, the module performs a system scan where all the three levels of scan are applicable. This is followed by a band scan, where there is an option to restrict the scan to level 0, level 0 and 1, level 0, 1, and 2 or level 2 only:</p> <ul style="list-style-type: none"> • 0 (factory-programmed value): preference not specified. Platform's default behavior performs all level 0, 1, and 2 scans • 1: level 0 scan only • 2: level 0 and 1 scans • 3: level 0, 1, and 2 scans • 5: level 2 scan only <p> SARA-R422 / SARA-R422M8S / SARA-R422S If the GCF-PTCRB profile is set (+UMNOPROF: 201), the factory-programmed value is 1.</p> |

7.31.4 Notes

SARA-R410M-02B / SARA-R412M

- The command is not supported by SARA-R410M-02B-00, SARA-R410M-02B-01, SARA-R410M-02B-02, SARA-R412M-02B-00, SARA-R412M-02B-01, or SARA-R412M-02B-02.

7.32 Retrieve coverage enhancement mode information +CEINFO

| +CEINFO | | | | | | |
|------------|-----------------------------------|--------------|----------------|----------------|---------------|-----------------|
| Modules | SARA-R422 SARA-R422M8S SARA-R422S | | | | | |
| Attributes | Syntax | PIN required | Settings saved | Can be aborted | Response time | Error reference |
| | full | No | No | No | - | +CME Error |

7.32.1 Description

Configures the current coverage enhancement (CE) mode reporting URC. After enabling the URC reporting (<reporting>=1), the +CEINFO URC is issued to return the current CE mode information: thereafter, if either the parameter <CE_enabled> or <UE_state> or <downlink_repetition_factor> or <uplink_repetition_factor> changes, a +CEINFO URC will be issued.

7.32.2 Syntax

| Type | Syntax | Response | Example |
|------|-----------------------|--|-----------------------------------|
| Set | AT+CEINFO=<reporting> | OK | AT+CEINFO=1 OK |
| Read | AT+CEINFO? | +CEINFO: <reporting>,<CE_enabled>,<UE_state>,<downlink_repetition_factor>,<uplink_repetition_factor>,<RSRP_value>,<CINR> OK | +CEINFO: 1,1,R,8,32,-120,10 OK |
| Test | AT+CEINFO=? | +CEINFO: (list of supported <reporting>s) OK | +CEINFO: (0-1) OK |
| URC | | +CEINFO: <reporting>,<CE_enabled>,<UE_state>,<downlink_repetition_factor>,<uplink_ | +CEINFO: 1,1,R,8,32,-120,10 |

| Type | Syntax | Response | Example |
|------|--------|--|---------|
| | | repetition_factor>,<RSRP_value>,<CINR> | |

7.32.3 Defined values

| Parameter | Type | Description |
|------------------------------|--------|---|
| <reporting> | Number | Enables/disables the +CEINFO URC. Allowed values: <ul style="list-style-type: none"> 0 (default value): +CEINFO URC disabled 1: +CEINFO URC enabled |
| <CE_enabled> | Number | Indicates whether the serving cell supports CE mode A/B. Allowed values: <ul style="list-style-type: none"> 0: CE mode A/B disabled 1: CE mode A/B enabled |
| <UE_state> | String | UE state. Allowed values: <ul style="list-style-type: none"> I: idle R: RACH C: connected to the network |
| <downlink_repetition_factor> | Number | Downlink repetition factor. The range goes from 0 to 65535, 0 if not known or detectable. If the UE state is idle (<UE_state>=I) or RACH (<UE_state>=R), the downlink repetition factor is set to mpdcch-NumRepetition according to current radio condition (i.e. RSRP) and prach-ParametersListCE-r13 in SIB2 if access technology is LTE-M. If the UE state is connected (<UE_state>=C), the downlink repetition factor is set to mpdcch-NumRepetition for the radio bearer if access technology is LTE-M. For more details, see the 3GPP TS 36.331 [118]. |
| <uplink_repetition_factor> | Number | Uplink repetition factor. The range goes from 0 to 65535, 0 if not known or detectable. If the UE state is idle (<UE_state>=I), the uplink repetition factor is set to numRepetitionPerPreambleAttempt according to the current radio condition. If the UE state is RACH (<UE_state>=R), the uplink repetition factor is set to numRepetitionPerPreambleAttempt selected by UE. If the UE state is RACH (<UE_state>=C), the uplink repetition factor is set to repetition number for PUSCH if access technology is LTE-M. For more details, see the 3GPP TS 36.331 [118]. |
| <RSRP_value> | Number | Current Reference Signal Received Power (RSRP) expressed in dBm. The range goes from -140 dBm to -44 dBm, 0 if not known or not detectable. |
| <CINR> | Number | Carrier-to-Interference and Noise Ratio (CINR) expressed in dBm. The range goes from -23 dB to 40 dB, 0 if not known or not detectable. |

8 Device lock

8.1 Enter PIN +CPIN

| +CPIN | | | | | | |
|-------------------|---------------|---------------------|-----------------------|-----------------------|----------------------|------------------------|
| Modules | All products | | | | | |
| Attributes | Syntax | PIN required | Settings saved | Can be aborted | Response time | Error reference |
| | full | No | No | No | < 10 s | +CME Error |

8.1.1 Description

Enter PIN. If no PIN request is pending, the corresponding error code is returned. If a wrong PIN is given three times, the PUK must be inserted in place of the PIN, followed by the <newpin> which replaces the old pin in the SIM.

8.1.2 Syntax

| Type | Syntax | Response | Example |
|------|--------------------------|---------------------|----------------------|
| Set | AT+CPIN=<pin>[,<newpin>] | OK | AT+CPIN="0933" OK |
| Read | AT+CPIN? | +CPIN: <code> OK | +CPIN: SIM PIN OK |
| Test | AT+CPIN=? | OK | |

8.1.3 Defined values

| Parameter | Type | Description |
|-----------------|--------|---|
| <pin>, <newpin> | String | 4-to-8 characters long string of decimal digits. If only PIN is required, <newpin> is not to be entered. If PUK is required, <pin> must be the PUK and <newpin>, the new PIN code, must be entered as well. |
| <code> | String | <ul style="list-style-type: none"> READY: MT is not pending for any password SIM PIN: MT is waiting SIM PIN to be given SIM PUK: MT is waiting SIM PUK to be given SIM PIN2: MT is waiting SIM PIN2 to be given SIM PUK2: MT is waiting SIM PUK2 to be given PH-NET PIN: MT is waiting network personalization password to be given PH-NETSUB PIN: MT is waiting network subset personalization password to be given PH-SP PIN: MT is waiting service provider personalization password to be given PH-CORP PIN: MT is waiting corporate personalization password to be given PH-SIM PIN: MT is waiting phone to SIM/UICC card password to be given |

8.1.4 Notes

- The command needs the SIM module to work correctly
- If PIN is not inserted the following situation can occur:

| Command | Response |
|-----------|------------------------------|
| AT+CMEE=2 | OK |
| AT+COPS=0 | +CME ERROR: SIM PIN required |
| AT+CMEE=0 | OK |
| AT+COPS=0 | ERROR |

- To change the PIN the user must use the AT+CPWD="SC",<old_pin>,<new_pin> command (see [+CPWD](#) AT command for details). Example:



```
AT+CPWD="SC", "1234", "4321"
```

8.2 Facility lock +CLCK

| +CLCK | | | | | | |
|------------|--------------|--------------|----------------|----------------|---------------|-----------------|
| Modules | All products | | | | | |
| Attributes | Syntax | PIN required | Settings saved | Can be aborted | Response time | Error reference |
| | full | Yes | No | Yes | Up to 3 min | +CME Error |

8.2.1 Description

Locks, unlocks or interrogates an MT or a network facility <fac>. A password is normally needed to do such actions. When querying the status of a network service (<mode>=2) the information text response for "not active" case (<status>=0) is returned only if the service is not active for any <class>. Instead when querying the status of a network service (<mode>=2) asking for a specific <class>, the DUT sends a generic request. The command can be aborted if network facilities are set or interrogated.

-  For <fac> "PN", "PU", "PP", "PC" and "PS" only <mode>=0 and <mode>=2 (unlock and query status) are always supported.
-  For <fac> "PN", "PU", "PP", "PC" and "PS" <mode>=1 (lock status) is supported only if proper re-activation characteristic is enabled during personalization.

8.2.2 Syntax

| Type | Syntax | Response | Example |
|------|---|---|---|
| Set | AT+CLCK=<fac>,<mode>[,<passwd>[,<class>]] | OK or +CLCK: <status>[,<class1>] [...] [+CLCK: <status>[,<class1>]] OK | AT+CLCK="SC",1,"0933" OK |
| Test | AT+CLCK=? | +CLCK: (list of supported <fac>s) OK | +CLCK: ("SC","PN","PU","PP","PC", "PS","FD","AO","OI","OX","AI","IR", "AB","AG","AC") OK |

8.2.3 Defined values

| Parameter | Type | Description |
|-----------|--------|---|
| <fac> | String | Facility values. Allowed values (for the applicability to the module see Table 7): <ul style="list-style-type: none"> • "SC": SIM (PIN enabled/disabled) • "PN": Network Personalisation (see the 3GPP TS 22.022 [75]) • "PU": network sUbset Personalisation (see the 3GPP TS 22.022 [75]) • "PP": service Provider Personalisation (see the 3GPP TS 22.022 [75]) • "PC": Corporate Personalisation (see the 3GPP TS 22.022 [75]) • "PS": SIM/USIM Personalisation (see the 3GPP TS 22.022 [75]) • "FD": SIM fixed dialling phonebook feature • "AO": BAR (Bar All Outgoing Calls) • "OI": BOIC (Bar Outgoing International Calls) • "OX": BOIC-exHC(Bar Outgoing International Calls except to Home Country) • "AI": BAIC (Bar All Incoming Calls) • "IR": BIC-Roam (Bar Incoming Calls when Roaming outside the home country) • "AB": All Barring services (applicable only for <mode>=0) • "AG": All outGoing barring services (applicable only for <mode>=0) • "AC": All inComing barring services (applicable only for <mode>=0) • "CS": CNTRL (lock CoNTRoL surface (e.g. phone keyboard)) (see the 3GPP TS 27.007 [58]) • "PF": Lock Phone to the very First inserted SIM/UICC card (see the 3GPP TS 27.007 [58]) • "NT": Barr incoming calls from numbers Not stored to TA memory (see the 3GPP TS 27.007 [58]) |

| Parameter | Type | Description |
|-----------|--------|--|
| | | <ul style="list-style-type: none"> "NM": Barr incoming calls from numbers Not stored to MT memory (see 3GPP TS 27.007 [58]) "NS": Barr incoming calls from numbers Not stored to SIM/UICC memory (see the 3GPP TS 27.007 [58]) "NA": Barr incoming calls from numbers Not stored in any memory (see the 3GPP TS 27.007 [58]) |
| <mode> | Number | <ul style="list-style-type: none"> 0: unlock 1: lock 2: query status |
| <status> | Number | <ul style="list-style-type: none"> 0: not active 1: active |
| <passwd> | String | Shall be the same as password specified for the facility from the MT user interface or with the +CPWD command |
| <class> | Number | Sum of numbers each representing a class of information. The default value is 7 (voice + data + fax): <ul style="list-style-type: none"> 1: voice 2: data 4: FAX 8: short message service 16: data circuit sync 32: data circuit async 64: dedicated packet access 128: dedicated PAD access |

8.2.4 Notes

| Module series | SC | PN | PU | PP | PC | PS | FD | AO | OI | OX | AI | IR | AB | AG | AC | CS | PF | NT | NM | NS | NA | |
|-------------------|----|----|----|----|----|----|----|----|----|----|----|----|----|----|----|----|----|----|----|----|----|--|
| SARA-R4 / SARA-N4 | x | x | x | x | x | | x | | | | | | | | | | x | | | | | |

Table 7: Lock applicability (<fac> allowed values)

SARA-R4 / SARA-N4

- This command is abortable.

8.3 Change password +CPWD

| +CPWD | | | | | | |
|------------|--------------|--------------|----------------|----------------|---------------|-----------------|
| Modules | All products | | | | | |
| Attributes | Syntax | PIN required | Settings saved | Can be aborted | Response time | Error reference |
| | full | Yes | No | Yes | Up to 3 min | +CME Error |

8.3.1 Description

Sets a new password for the facility lock function defined by the **+CLCK** AT command. The command is abortable if a character is sent to the DCE during the command execution.

8.3.2 Syntax

| Type | Syntax | Response | Example |
|------|---------------------------------|---|--|
| Set | AT+CPWD=<fac>,<oldpwd>,<newpwd> | OK | AT+CPWD="SC","0933","0934" OK |
| Test | AT+CPWD=? | +CPWD: list of available (<fac>,<pwdlength>s) OK | +CPWD: ("SC",8),("P2",8),("AO",4),("OI",4),("OX",4),("AI",4),("IR",4),("AB",4),("AG",4),("AC",4) OK |

8.3.3 Defined values

| Parameter | Type | Description |
|-------------|--------|---|
| <fac> | String | "P2" SIM PIN2; see the +CLCK command description for other values |
| <oldpwd> | String | Old password |
| <newpwd> | String | New password |
| <pwdlength> | Number | Length of password (digits) |

8.3.4 Notes

- If the PIN is blocked, an error result code will be provided when attempting to change the PIN code if the PIN check is disabled through [AT+CLCK](#) command.

9 Short Messages Service

9.1 Introduction

For a complete overview of SMS, see 3GPP TS 23.040 [63] and 3GPP TS 27.005 [69].

In case of errors all the SMS related AT commands return an error result code as defined in [Appendix A.2](#).

9.1.1 Class 0 SMS

The storing of a class 0 SMS depends on the module series:

- SARA-R422 / SARA-R422M8S / SARA-R422S - all incoming SMSes stored in <mem3> (preferred memory for storing the received SMS, see [+CPMS](#)) with increasing index.
- SARA-R404M / SARA-R410M / SARA-R412M / SARA-N4 - not stored.

9.1.2 <index> parameter range

The <index> parameter range depends on the memory storage type:

ME (ME message), **SM** ((U)SIM message) **MT** (ME + SM):

- SARA-R422 / SARA-R422M8S / SARA-R422S
 - Values between 0 and 22: SMS stored in ME.
 - Values between 0 and n-1: SMS stored in SIM (n is the number of records of the EF_{SMS} file in the SIM card used).
- SARA-R410M-63B / SARA-R410M-73B / SARA-R410M-83B
 - Values between 0 and 100: SMS stored in ME.
 - Values between 0 and n: SMS stored in SIM (n depends on SIM card used).
- SARA-R404M / SARA-R410M-01B / SARA-R410M-02B / SARA-R410M-52B / SARA-R412M / SARA-N4
 - Values between 0 and 23: SMS stored in ME.
 - Values between 0 and n: SMS stored in SIM (n depends on SIM card used).

BM (Broadcast Message):

- SARA-R4 / SARA-N4 - Broadcast Message storage is not supported.

SR (Status Report):

- SARA-R422 / SARA-R422M8S / SARA-R422S - values between 0 and m-1: Status Report messages stored in the SIM (m is the number of records of the EF_{SMSR} file in the SIM card). A Status Report message is stored in EF_{SMSR} file if, and only if, the EF_{SMSR} file is present on the SIM card and the MO SMS that requested the report is still present in EF_{SMS}. In case the MO SMS is not present in EF_{SMS}, and the <ds> parameter of the [+CNMI](#) AT command is set to 2, the URC indication corresponding to an incoming Status Report will always be **+CDSI: "SR",x** but x will indicate the position in memory (RAM) where it has been temporarily stored. This memory cannot be recalled for actually reading the Status Reports stored in it, but it is only used to report their reception.
- SARA-R404M / SARA-R410M / SARA-R412M / SARA-N4 - Status Report storage is not supported.

9.1.3 Limitations

The following limitations apply related to the SMS usage:

Single SMS

- 160 characters if <dc>="GSM 7 bit default alphabet data"
- 140 octets if <dc>="8-bit data"
- 70 UCS2 characters (2 bytes for each one) if <dc>="16-bit uncompressed UCS2 data"

Concatenated SMS (where supported) - "8-bit reference number" type

- 153 characters if <dc>="GSM 7 bit default alphabet data"
- 134 octets if <dc>="8-bit data"
- 67 UCS2 characters (2 bytes for each one) if <dc>="16-bit uncompressed UCS2 data"

Concatenated SMS (where supported) - "16-bit reference number" type

- The limits are the same as the "8-bit reference number" type, but are decreased by one unit.

A concatenated SMS can have as many as 255 parts.

9.2 Select message service +CSMS

| +CSMS | | | | | | |
|-------------------|---------------|---------------------|-----------------------|-----------------------|----------------------|----------------------------|
| Modules | All products | | | | | |
| Attributes | Syntax | PIN required | Settings saved | Can be aborted | Response time | Error reference |
| | full | Yes | No | No | - | +CMS Error |

9.2.1 Description

Selects the <service> message service. It returns the types of messages supported by the MT.

9.2.2 Syntax

| Type | Syntax | Response | Example |
|------|-------------------|---|---------------------------------|
| Set | AT+CSMS=<service> | +CSMS: <mt>,<mo>,<bm> OK | AT+CSMS=1 +CSMS: 1,1,1 OK |
| Read | AT+CSMS? | +CSMS: <service>,<mt>,<mo>,<bm> OK | +CSMS: 0,1,1,1 OK |
| Test | AT+CSMS=? | +CSMS: (list of supported <service>s) OK | +CSMS: (0-1) OK |

9.2.3 Defined values

| Parameter | Type | Description |
|-----------|--------|--|
| <service> | Number | Allowed values: <ul style="list-style-type: none"> 0: see 3GPP TS 23.040 [63] and 3GPP TS 23.041 [64]; syntax of AT commands is compatible with 3GPP TS 27.005 [69] phase 2; phase 2+ features may be supported if no new command syntax is required 1: see 3GPP TS 23.040 [63] and 3GPP TS 23.041 [64]; syntax of AT commands is compatible with 3GPP TS 27.005 [69] phase 2+ |
| <mt> | Number | Mobile terminated messages: <ul style="list-style-type: none"> 0: not supported 1: supported |
| <mo> | Number | Mobile originated messages: <ul style="list-style-type: none"> 0: not supported 1: supported |
| <bm> | Number | Broadcast messages: <ul style="list-style-type: none"> 0: not supported 1: supported |

9.2.4 Notes

SARA-R4 / SARA-N4

- To activate correctly the manual acknowledge (see [+CNMA](#) AT command), set <service> to 1 before changing the settings of the [+CNMI](#) AT command to route the messages directly to TE.
- Set <service> to 1 to acknowledge an incoming message (either SMS or Status Report) with [+CNMA](#) AT command.
- If <service> is changed from 1 to 0 and one or more parameters of the [+CNMI](#) command are in phase 2+, switch the [+CNMI](#) parameters to phase 2 specific values before entering phase 2.

9.3 Preferred message storage +CPMS

| +CPMS | | | | | | |
|------------|--------------|--------------|----------------|----------------|---------------|-----------------|
| Modules | All products | | | | | |
| Attributes | Syntax | PIN required | Settings saved | Can be aborted | Response time | Error reference |
| | partial | Yes | NVM | No | Up to 3 min | +CMS Error |

9.3.1 Description

Selects memory storages <mem1>, <mem2> and <mem3>. If the chosen storage is supported by the MT but not suitable, the +CMS ERROR: <err> error result code should be returned.

See the test command for the supported memory types for each memory storage.

9.3.2 Syntax

| Type | Syntax | Response | Example |
|------|----------------------------------|--|---|
| Set | AT+CPMS=<mem1>[,<mem2>[,<mem3>]] | AT+CPMS: <used1>,<total1>,<used2>,<total2>,<used3>,<total3> OK | AT+CPMS="BM","SM","SM" +CPMS: 0,5,0,50,0,50 OK |
| Read | AT+CPMS? | +CPMS: <mem1>,<used1>,<total1>,<mem2>,<used2>,<total2>,<mem3>,<used3>,<total3> OK | +CPMS: "MT",4,350,"MT",4,350,"MT",4,350 OK |
| Test | AT+CPMS=? | +CPMS: (list of supported <mem1>s),(list of supported <mem2>s),(list of supported <mem3>s) OK | +CPMS: ("MT","ME","SM","BM","SR"),("MT","ME","SM"),("MT","ME","SM") OK |

9.3.3 Defined values

| Parameter | Type | Description |
|-----------|--------|--|
| <mem1> | String | Memory used to read and delete messages. The supported values may vary: <ul style="list-style-type: none"> "ME": ME message storage "SM": (U)SIM message storage "MT": "ME"+"SM", "ME" preferred "BM": Broadcast Message storage "SR": Status Report storage The default value is the currently set value. The factory-programmed value depends on the module series: see Notes for more details. |
| <mem2> | String | Memory used to write and send SMS. The supported values may vary: <ul style="list-style-type: none"> "ME": ME message storage "SM": (U)SIM message storage "MT": "ME"+"SM", "ME" preferred The default value is the currently set value. The factory-programmed value depends on the module series: see Notes for more details. |
| <mem3> | String | Memory preferred to store the received SMS. The supported values may vary: <ul style="list-style-type: none"> "ME": ME message storage "SM": (U)SIM message storage "MT": "ME"+"SM", "ME" preferred The default value is the currently set value. The factory-programmed value depends on the module series: see Notes for more details. |
| <used1> | Number | Number of used message locations in <mem1> |
| <total1> | Number | Total number of message locations in <mem1> |
| <used2> | Number | Number of used message locations in <mem2> |
| <total2> | Number | Total number of message locations in <mem2> |
| <used3> | Number | Number of used message locations in <mem3> |
| <total3> | Number | Total number of message locations in <mem3> |

9.3.4 Notes

- SARA-R4 / SARA-N4 - the factory-programmed value is "ME", "ME" and "ME".

SARA-R4 / SARA-N4

- "MT" message storage is not supported.

SARA-R422 / SARA-R422M8S / SARA-R422S

- If <mem3> is set to "ME", this memory will be filled up first, when it is full the "SM" will be filled up and only when also this memory is full, the service center will be informed in order to suspend sending messages to the module.
- If <mem3> is set to "SM", this memory will be filled up first, when it is full the "ME" will be filled up and only when also this memory is full, the service center will be informed in order to suspend sending messages to the module.

9.4 Preferred message format +CMGF

| +CMGF | | | | | | |
|------------|--------------|--------------|-------------------------|----------------|---------------|----------------------------|
| Modules | All products | | | | | |
| Attributes | Syntax | PIN required | Settings saved | Can be aborted | Response time | Error reference |
| | full | Yes | Profile | No | - | +CMS Error |

9.4.1 Description

Indicates to the MT which input and output format of messages shall be used.

9.4.2 Syntax

| Type | Syntax | Response | Example |
|------|------------------|--|--------------------|
| Set | AT+CMGF=[<mode>] | OK | AT+CMGF=1 OK |
| Read | AT+CMGF? | +CMGF: <mode> OK | +CMGF: 1 OK |
| Test | AT+CMGF=? | +CMGF: (list of supported <mode>s) OK | +CMGF: (0-1) OK |

9.4.3 Defined values

| Parameter | Type | Description |
|-----------|--------|---|
| <mode> | Number | Indicates the format of messages used with send, list, read and write commands and URCs resulting from receiving SMSes messages: <ul style="list-style-type: none"> 0 (default and factory-programmed value): PDU mode 1: text mode |

9.4.4 Notes

SARA-R4 / SARA-N4

- The command setting is not stored in the personal profile.
- The <mode> parameter is mandatory.

9.5 Save settings +CSAS

| +CSAS | | | | | | |
|-------------------|---------------|---------------------|-----------------------|-----------------------|----------------------|------------------------|
| Modules | All products | | | | | |
| Attributes | Syntax | PIN required | Settings saved | Can be aborted | Response time | Error reference |
| | full | No | No | No | - | +CMS Error |

9.5.1 Description

Saves active message service settings from the current active memory (RAM) to non-volatile memory (NVM). The settings related to the +CSCA (the current SMSC address stored in RAM), +CSMP and +CSCB commands are stored in a specific SMS profile (only one profile is available).

9.5.2 Syntax

| Type | Syntax | Response | Example |
|------|---------------------|---|------------------|
| Set | AT+CSAS[=<profile>] | OK | AT+CSAS OK |
| Test | AT+CSAS=? | +CSAS: (list of supported <profile>s) OK | +CSAS: (0) OK |

9.5.3 Defined values

| Parameter | Type | Description |
|-----------|--------|---|
| <profile> | Number | Specific SMS profile index where to store the active message settings. The factory-programmed value is 0. |

9.6 Restore settings +CRES

| +CRES | | | | | | |
|-------------------|---------------|---------------------|-----------------------|-----------------------|----------------------|------------------------|
| Modules | All products | | | | | |
| Attributes | Syntax | PIN required | Settings saved | Can be aborted | Response time | Error reference |
| | full | Yes | No | No | < 10 s | +CMS Error |

9.6.1 Description

Restores message service settings from a non-volatile memory (NVM) to the current active memory (RAM). The settings related to the +CSCA (the SMSC address in the SIM card is also updated), +CSMP and +CSCB commands are read from a specific SMS profile (only one profile is available).

9.6.2 Syntax

| Type | Syntax | Response | Example |
|------|---------------------|---|------------------|
| Set | AT+CRES[=<profile>] | OK | AT+CRES=0 OK |
| Test | AT+CRES=? | +CRES: (list of supported <profile>s) OK | +CRES: (0) OK |

9.6.3 Defined values

| Parameter | Type | Description |
|-----------|--------|--|
| <profile> | Number | Specific SMS profile index from where to read the message service settings |

9.7 Show text mode parameters +CSDH

| +CSDH | | | | | | |
|-------------------|---------------|---------------------|-----------------------|-----------------------|----------------------|----------------------------|
| Modules | All products | | | | | |
| Attributes | Syntax | PIN required | Settings saved | Can be aborted | Response time | Error reference |
| | full | Yes | No | No | - | +CMS Error |

9.7.1 Description

Controls whether detailed SMS header information is shown in text mode (see the [AT+CMGF=1](#) command).

This affects the responses of the [+CMGR](#), [+CMGL](#), [+CSMP](#), [+CSCA](#) AT commands and the [+CMT](#), [+CMTI](#), [+CDS](#), [+CDSI](#), [+CBM](#), [+CBMI](#) (see [+CNMI](#)) URCS.

9.7.2 Syntax

| Type | Syntax | Response | Example |
|------|------------------|--|--------------------|
| Set | AT+CSDH=[<show>] | OK | AT+CSDH=1 OK |
| Read | AT+CSDH? | +CSDH: <show> OK | +CSDH: 0 OK |
| Test | AT+CSDH=? | +CSDH: (list of supported <show>s) OK | +CSDH: (0-1) OK |

9.7.3 Defined values

| Parameter | Type | Description |
|-----------|--------|---|
| <show> | Number | Allowed values: <ul style="list-style-type: none"> 0 (default): do not show detailed SMS header information 1: show detailed SMS header information |

9.7.4 Notes

SARA-R4 / SARA-N4

- The <show> parameter is mandatory in the set command.

9.8 New message indication +CNMI

| +CNMI | | | | | | |
|-------------------|---------------|---------------------|-------------------------|-----------------------|----------------------|----------------------------|
| Modules | All products | | | | | |
| Attributes | Syntax | PIN required | Settings saved | Can be aborted | Response time | Error reference |
| | partial | Yes | Profile | No | - | +CMS Error |

9.8.1 Description

Selects the procedure to indicate the reception of a new SMS in case of the MT is active (the DTR signal is ON). If the MT is inactive (the DTR signal is OFF), the message reception should be done as specified in 3GPP TS 23.038 [62].

The +UCMT URC notifies the SMS-DELIVER status for 3GPP2 Mobile Terminated SMSes; it is equivalent to +CMT but valid only for 3GPP2 SMS (i.e. 3GPP2 SMS over IMS received on Verizon MNO).

9.8.2 Syntax

| Type | Syntax | Response | Example |
|------|---|--|------------------------|
| Set | AT+CNMI=[<mode>[,<mt>[,<bm>[,<ds>[,<bfr>]]]]] | OK | AT+CNMI=1,1 OK |
| Read | AT+CNMI? | +CNMI: <mode>,<mt>,<bm>,<ds>,<bfr> OK | +CNMI: 0,0,0,0,0 OK |

| Type | Syntax | Response | Example |
|------|-----------|--|---|
| Test | AT+CNMI=? | +CNMI: (list of supported <mode>s), (list of supported <mt>s), (list of supported <bm>s), (list of supported <ds>s), (list of supported <bfr>s) OK | +CNMI: (0-2),(0-3),(0-3),(0-2),(0-1) OK |
| URC | | +CMTI: <mem>,<index> | +CMTI: "SM",5 |
| URC | | Text mode (+CMGF=1): +CMT: <oa>,<alpha>,<scts>[,<toa>,<fo>,<pid>,<dcs>,<sca>,<tosca>,<length>]<CR><LF><data> PDU mode (+CMGF=0): +CMT: ,<length><CR><LF><pdu> | +CMT: "+393475234652",,"14/11/21,11:58:23+01" Hello world |
| URC | | Text mode (+CMGF=1): +UCMT: <message_id>,<oa>,<scts>,[<priority>],[<privacy>],[<callback_number>],[<encoding>],[<status>],[<num_sms>,<part>,<reference>],[<length><CR><LF><text> PDU mode (+CMGF=0): +UCMT: <pdu_length><CR><LF><pdu> | +UCMT: 1,+1231241241,"18:02:28+08",,"2,,,,,6 Hello! |
| URC | | +CBMI: <mem>,<index> | +CBMI: "BM",48 |
| URC | | Text mode (+CMGF=1): +CBM: <sn>,<mid>,<dcs>,<page>,<pages><CR><LF><data> PDU mode (+CMGF=0): +CBM: <length><CR><LF><pdu> | +CBM: 271,1025,1,1,1 The quick brown fox jumps over the lazy dog 0123456789 |
| URC | | +CDSI: <mem>,<index> | +CDSI: "MT",2 |
| URC | | Text mode (+CMGF=1): +CDS: <fo>,<mr>,[<ra>],[<tora>],[<scts>,<dt>,<st> PDU mode (+CMGF=0): +CDS: <length><CR><LF><pdu> | +CDS: 6,202,"+393492323583",145,"14/07/25,13:07:16+02","14/07/25,16:35:44+02",0 |

9.8.3 Defined values

| Parameter | Type | Description |
|-----------|--------|--|
| <mode> | Number | Controls the processing of URCS specified within this command: <ul style="list-style-type: none"> 0 (default value): buffer URCS in the MT; if the MT buffer is full, the oldest indication may be discarded and replaced with the new received indications (ring buffer) 1 (factory-programmed value): discard indication and reject new received message URCS when MT-DTE link is reserved; otherwise forward them directly to the DTE 2: buffer URCS in the MT when the serial link is busy (e.g. data-transfer); otherwise forward them directly to the DTE 3: forward URCS directly to the TE. TA-TE link specific inband technique used to embed result codes and data when MT is in on-line data mode |
| <mt> | Number | Specifies the rules for managing the received SMS according the message's Data Coding Scheme (DCS): <ul style="list-style-type: none"> 0 (default and factory-programmed value): No SMS-DELIVER indications are routed to the TE 1: if SMS-DELIVER is stored in the MT, indication of the memory location is routed to the DTE using the +CMTI URC 2: SMS-DELIVER (except class 2 SMS) are routed directly to the DTE (but not saved in the module file system or SIM memory) using the +CMT URC. If MT has its own display device then class 0 SMS and SMS in the message waiting indication group (discard message) may be copied to both MT display and to DTE. In this case MT |

| Parameter | Type | Description |
|-----------|--------|--|
| | | shall send the acknowledgement to the network. Class 2 SMSs and messages in the message waiting indication group (storage message) result in indication as defined in <mt>=1 |
| | | <ul style="list-style-type: none"> • 3: Class 3 SMS-DELIVERs are routed directly to DTE using URCs defined in <mt>=2. Messages of other data coding schemes result in indication as defined in <mt>=1 |
| <bm> | Number | Specifies the rules for managing the received Cell Broadcast messages (CBM): <ul style="list-style-type: none"> • 0 (default and factory-programmed value): no CBM indications to the DTE • 1: if the CBM is stored in the MT, an indication of the used memory location is routed to DTE using the +CBMI URC • 2: new CBMs are routed directly to the DTE using the +CBM URC • 3: class 3 CBMs are routed directly to DTE using URCs defined in <bm>=2. If CBM storage is supported, messages of other classes result in indication as defined in <bm>=1 |
| <ds> | Number | Specifies the rules for managing the Status Report messages: <ul style="list-style-type: none"> • 0 (default and factory-programmed value): no SMS-STATUS-REPORTs are routed to the DTE • 1: SMS-STATUS-REPORTs are routed to the DTE using the +CDS URC • 2: if SMS-STATUS-REPORT is stored in the MT, the indication of the memory location is routed to the DTE using the +CDSI URC |
| <bfr> | Number | Controls the buffering of URCs: <ul style="list-style-type: none"> • 0 (default and factory-programmed value): MT buffer of URCs defined within this command is flushed to the DTE when <mode> 1...3 is entered (OK final result code shall be given before flushing the codes). • 1: MT buffer of URCs defined within this command is cleared when <mode> 1...3 is entered |
| <mem> | String | Same as defined in +CPMS Defined Values |
| <index> | Number | Storage position |
| <length> | Number | Two meanings: <ul style="list-style-type: none"> • in text mode: number of characters • in PDU mode: PDU's length in octets without the Service Center's address. In example: 039121430100038166F6000004E374F80D: this is a PDU with Service Center's number +1234, that generates the address 03912143 (4 octets). Thus in this case <length>=13. |
| <pdu> | String | Protocol data unit: each 8-bit octet is presented as two IRA character long hexadecimal numbers, e.g. octet with integer value 42 is presented to TE as two characters 2A (IRA 50 and 65) |
| <oa> | String | Originator address |
| <scts> | String | Service center time stamp in time-string format, see the <dt> |
| <data> | String | In the case of SMS: 3GPP TS 23.040 [63] TP-User-Data in text mode responses; format: <ul style="list-style-type: none"> • if <dc> indicates that 3GPP TS 23.038 [62] GSM 7 bit default alphabet is used: <ul style="list-style-type: none"> o if TE character set other than "HEX" (see the +CSCS command in 3GPP TS 27.007 [58]): ME/TA converts GSM alphabet into current TE character set according to rules of Annex A o if TE character set is "HEX": ME/TA converts each 7-bit character of GSM 7 bit default alphabet into two IRA character long hexadecimal number (e.g. character Æ (GSM 7 bit default alphabet 28) is presented as 1C (IRA 49 and 67)) • if <dc> indicates that 8-bit or UCS2 data coding scheme is used: ME/TA converts each 8-bit octet into two IRA character long hexadecimal number (e.g. octet with integer value 42 is presented to TE as two characters 2A (IRA 50 and 65)) In the case of CBS: 3GPP TS 23.041 [64] CBM Content of Message in text mode responses; format: <ul style="list-style-type: none"> • if <dc> indicates that 3GPP TS 23.038 [62] GSM 7 bit default alphabet is used: <ul style="list-style-type: none"> o if TE character set other than "HEX" (see the +CSCS in 3GPP TS 27.007 [58]): ME/TA converts GSM alphabet into current TE character set according to rules of Annex A o if TE character set is "HEX": ME/TA converts each 7-bit character of the GSM 7 bit default alphabet into two IRA character long hexadecimal number • if <dc> indicates that 8-bit or UCS2 data coding scheme is used: ME/TA converts each 8-bit octet into two IRA character long hexadecimal number |
| <sn> | Number | CBM serial number |

| Parameter | Type | Description |
|-------------------|--------|--|
| <mid> | Number | CBM message identifier |
| <dc> | Number | Data Coding Scheme |
| <page> | Number | CBM Page Parameter bits 4-7 in integer format as described in 3GPP TS 23.041 [64] |
| <pages> | Number | CBM Page Parameter bits 0-3 in integer format as described in 3GPP TS 23.041 [64] |
| <fo> | Number | First octet of the SMS TPDU (see 3GPP TS 23.040 [63]) |
| <mr> | Number | Message reference |
| <ra> | String | Recipient address field |
| <tora> | Number | Type of address of <ra> - octet |
| <dt> | String | Discharge time in format "yy/MM/dd,hh:mm:ss+zz"; the time zone is expressed in steps of 15 minutes. The range goes from -48 to +56 |
| <st> | Number | Status of a SMS STATUS-REPORT |
| <message_id> | Number | Message-ID of the 3GPP2 SMS |
| <priority> | Number | 3GPP2 priority: <ul style="list-style-type: none"> • 0: normal • 1: interactive • 2: urgent • 3: emergency |
| <privacy> | Number | 3GPP2 privacy: <ul style="list-style-type: none"> • 0: not restricted • 1: restrictive • 2: confidential • 3: secret |
| <callback_number> | String | Callback number |
| <encoding> | Number | Text encoding: <ul style="list-style-type: none"> • 0: octet, unspecified • 2: ASCII7 • 3: IA5 • 4: UCS2 • 8: ISO 8859-1 • 9: GSM7 |
| <num_sms> | Number | Total number of SMS |
| <part> | Number | Fragment part number |
| <reference> | Number | 3GPP2 reference ID |

9.8.4 Notes

SARA-R4 / SARA-N4

- The command setting is not stored in the personal profile.
- The <mode> parameter is mandatory.
- <mode> = 3 is not supported.
- The +UCMT URC is not supported.
- The <ds> parameter can be set to 1 only if <mode>=1.
- The <mt> parameter can be set to 2 or 3 only if <mode>=1. If <mode>=2 or 3, then the <mt> parameter can only be 0 or 1.
- The incoming SMS/CBM URC indications will be displayed on all MUX logical channels except for the channel reserved for GNSS tunneling. As a general rule, the command should be issued by the DTE:
 - o After start-up
 - o After using the **Z** and **&F** command (which reset the command configuration)
 - o Whenever the incoming SMS URCs indications are requested on a different AT interface

9.9 Select service for MO SMS messages +CGSMS

| +CGSMS | | | | | | |
|------------|-----------------------------------|--------------|----------------|----------------|---------------|-----------------|
| Modules | SARA-R422 SARA-R422M8S SARA-R422S | | | | | |
| Attributes | Syntax | PIN required | Settings saved | Can be aborted | Response time | Error reference |
| | partial | No | NVM | No | - | +CME Error |

9.9.1 Description

Specifies the service (PS or CS) or service preference that the MT will use to send MO SMS messages.

In particular:

- in 2G RAT, PS service means GPRS and CS service means transmission on GSM dedicated channels;
- in 3G RAT, PS service means transmission on PS domain SRB (Signalling Radio Bearer) and CS service means transmission on CS domain SRB; SRB can be mapped to several UMTS transport channels, e.g. RACH/FACH or DCH;
- in 4G RAT, PS service means IMS messaging on EPS bearers and CS service means transmission on SGs (Signalling Gateways).

9.9.2 Syntax

| Type | Syntax | Response | Example |
|------|----------------------|--|---------------------|
| Set | AT+CGSMS=[<service>] | OK | AT+CGSMS=1 OK |
| Read | AT+CGSMS? | +CGSMS: <service> OK | +CGSMS: 1 OK |
| Test | AT+CGSMS=? | +CGSMS: (list of supported <service>s) OK | +CGSMS: (0-3) OK |

9.9.3 Defined values

| Parameter | Type | Description |
|-----------|--------|---|
| <service> | Number | Service or service preference to be used: <ul style="list-style-type: none"> • 0 (default value): PS • 1 (factory-programmed value): CS • 2: PS preferred (use CS if PS is not available) • 3: CS preferred (use PS if CS is not available) |

9.10 Read message +CMGR

| +CMGR | | | | | | |
|------------|--------------|--------------|----------------|----------------|---------------|-----------------|
| Modules | All products | | | | | |
| Attributes | Syntax | PIN required | Settings saved | Can be aborted | Response time | Error reference |
| | full | Yes | No | No | <10 s | +CMS Error |

9.10.1 Description

Returns the message with location value <index> from message storage <mem1> to the DTE.

- The parameters <tooa>, <fo>, <pid>, <dcs>, <sca>, <tosca>, <length>, <cdata> shall be displayed only if **AT+CSDH=1** is set.
- The syntax **AT+CMGR=0** allows to display an SMS class 0 if it is signaled to MT, because no MMI is available in the MT (see also the **+CNMI** AT command notes).
- If the <index> value is out of range (it depends on **AT+CPMS** command setting) or it refers to an empty position, then "+CMS ERROR: invalid memory index" error result code is returned.

9.10.2 Syntax

| Type | Syntax | Response | Example |
|------|--|--|--|
| Set | Text mode (+CMGF=1): AT+CMGR=<index> | SMS-DELIVER +CMGR: <stat>,<oa>,[<alpha>], <scts>[,<tooa>,<fo>,<pid>,<dcsc>,<scac>,<tosca>,<length>] <data> OK | AT+CMGR=303 +CMGR: "REC READ", "+393488535999",,"07/04/05,18:0 2:28+08",145,4,0,0,"+393492000 466",145,93 You have a missed called. Free information provided by your operator. |
| | | SMS-SUBMIT +CMGR: <stat>,<da>,[<alpha>],[<toda>,<fo>,<pid>,<dcsc>,<vp>], <scac>,<tosca>,<length>] <data> OK | OK |
| | | SMS-STATUS-report +CMGR: <stat>,<fo>,<mr>,[<ra>], [<tora>],<scts>,<dt>,<st> OK | |
| | | SMS-COMMAND +CMGR: <stat>,<fo>,<ct>[,<pid>, [<mn>],[<da>],[<toda>],<length> [<cdata>]] OK | |
| | | CBM storage +CMGR: <stat>,<sn>,<mid>,<dcsc>, <page>,<pages> <data> OK | |
| | PDU mode (+CMGF=0): AT+CMGR=<index> | +CMGR: <stat>,[<alpha>],<length> | AT+CMGR=1 |
| | | <pdu> | +CMGR: 1,,40 |
| | | OK | 0791934329002000040 C9193230982661400008070 328045218018D4F29CFE0 6B5CBF379F87C4EBF41E4340 82E7FD3C3 |
| | | | OK |
| Test | AT+CMGR=? | OK | |

9.10.3 Defined values

| Parameter | Type | Description |
|-----------|--------|--|
| <index> | Number | Storage position |
| <stat> | Number | <ul style="list-style-type: none"> 0: in PDU mode or "REC UNREAD" in text mode: received unread SMS 1: in PDU mode or "REC READ" in text mode: received read SMS 2: in PDU mode or "STO UNSENT" in text mode: stored unsent SMS 3: in PDU mode or "STO SENT" in text mode: stored sent SMS |
| <oa> | String | Originator address |
| <alpha> | String | Alphanumeric representation of <da> or <oa> corresponding to the entry found in the phonebook 3GPP TS 24.008 [67]. The parameter is not managed. |
| <scts> | String | Service center time stamp in time-string format, see <dt> |
| <tooa> | Number | Type of address of <oa> - octet |
| <fo> | Number | First octet of the SMS TPDU (see 3GPP TS 23.040 [63]) |
| <pid> | Number | TP-Protocol-Identifier (default 0); see the 3GPP TS 23.040 [63] |
| <dcsc> | Number | Data Coding Scheme |
| <scac> | String | Service center address field |

| Parameter | Type | Description | | | | | | | | | | |
|------------|---|--|------|-----------------------|----------|---|------------|--|------------|-----------------------|------------|------------------------|
| <tosca> | Number | Type of address of <sca> - octet in Number format (for more details see the 3GPP TS 24.008 [67]); default 145 when string includes '+', otherwise default 129 | | | | | | | | | | |
| <length> | Number | Two meanings: <ul style="list-style-type: none"> in text mode: number of characters in PDU mode: PDU's length in octets without the Service Center's address. In example 039121430100038166F6000004E374F80D: this is a PDU with Service Center's number +1234, that generates the address 03912143 (4 octets). Thus in this case <length> = 13. | | | | | | | | | | |
| <data> | String | In the case of SMS: 3GPP TS 23.040 [63] TP-User-Data in text mode responses; format: <ul style="list-style-type: none"> if <dcs> indicates that 3GPP TS 23.038 [62] GSM 7 bit default alphabet is used: <ul style="list-style-type: none"> if TE character set other than "HEX" (see +CSCS command description); ME/TA converts GSM alphabet into current TE character set according to rules of Annex A if TE character set is "HEX": ME/TA converts each 7-bit character of GSM 7 bit default alphabet into two IRA character long hexadecimal number (e.g. character Æ (GSM 7 bit default alphabet 28) is presented as 1C (IRA 49 and 67)) if <dcs> indicates that 8-bit or UCS2 data coding scheme is used: ME/TA converts each 8-bit octet into two IRA character long hexadecimal number (e.g. octet with integer value 42 is presented to TE as two characters 2A (IRA 50 and 65)) In the case of CBS: 3GPP TS 23.041 [64] CBM Content of Message in text mode responses; format: <ul style="list-style-type: none"> if <dcs> indicates that 3GPP TS 23.038 [62] GSM 7 bit default alphabet is used: <ul style="list-style-type: none"> if TE character set other than "HEX" (see +CSCS command description); ME/TA converts GSM alphabet into current TE character set according to rules of Annex A if TE character set is "HEX": ME/TA converts each 7-bit character of the GSM 7 bit default alphabet into two IRA character long hexadecimal number if <dcs> indicates that 8-bit or UCS2 data coding scheme is used: ME/TA converts each 8-bit octet into two IRA character long hexadecimal number | | | | | | | | | | |
| <da> | String | Destination address | | | | | | | | | | |
| <tda> | Number | Type of address of <da> - octet | | | | | | | | | | |
| <vp> | Number | Format depending of the <fo> setting: <ul style="list-style-type: none"> Relative format: validity period starting from when the SMS is received by the SMSC, in range 0-255 (default value 167); for more details see the 3GPP TS 23.040 [63] <table border="1" data-bbox="582 1310 1433 1489"> <thead> <tr> <th><vp></th> <th>Validity period value</th> </tr> </thead> <tbody> <tr> <td>0 to 143</td> <td>(TP-VP + 1) x 5 minutes (i.e. 5 minutes intervals up to 12 hours)</td> </tr> <tr> <td>144 to 167</td> <td>12 hours + ((TP-VP -143) x 30 minutes)</td> </tr> <tr> <td>168 to 196</td> <td>(TP-VP - 166) x 1 day</td> </tr> <tr> <td>197 to 255</td> <td>(TP-VP - 192) x 1 week</td> </tr> </tbody> </table> Absolute format: absolute time of the validity period termination in string format ("yy/MM/dd,hh:mm:ss+zz") (see the 3GPP TS 23.040 [63]); the time zone is expressed in steps of 15 minutes. The range goes from -48 to +56 | <vp> | Validity period value | 0 to 143 | (TP-VP + 1) x 5 minutes (i.e. 5 minutes intervals up to 12 hours) | 144 to 167 | 12 hours + ((TP-VP -143) x 30 minutes) | 168 to 196 | (TP-VP - 166) x 1 day | 197 to 255 | (TP-VP - 192) x 1 week |
| <vp> | Validity period value | | | | | | | | | | | |
| 0 to 143 | (TP-VP + 1) x 5 minutes (i.e. 5 minutes intervals up to 12 hours) | | | | | | | | | | | |
| 144 to 167 | 12 hours + ((TP-VP -143) x 30 minutes) | | | | | | | | | | | |
| 168 to 196 | (TP-VP - 166) x 1 day | | | | | | | | | | | |
| 197 to 255 | (TP-VP - 192) x 1 week | | | | | | | | | | | |
| <mr> | Number | Message reference | | | | | | | | | | |
| <ra> | String | Recipient address field | | | | | | | | | | |
| <tora> | Number | Type of address of <ra> - octet | | | | | | | | | | |
| <dt> | String | Discharge time in format "yy/MM/dd,hh:mm:ss+zz"; the time zone is expressed in steps of 15 minutes. The range goes from -48 to +56 | | | | | | | | | | |
| <st> | Number | Status of an SMS STATUS-REPORT | | | | | | | | | | |
| <ct> | Number | TP-Command-Type (default 0) | | | | | | | | | | |
| <mn> | Number | See the 3GPP TS 23.040 [63] TP-Message-Number in integer format | | | | | | | | | | |
| <cdata> | String | TP-Command-Data in text mode responses | | | | | | | | | | |
| <sn> | Number | CBM serial number | | | | | | | | | | |
| <mid> | Number | CBM message identifier | | | | | | | | | | |
| <page> | Number | 3GPP TS 23.041 [64] CBM Page Parameter bits 4-7 in integer format | | | | | | | | | | |
| <pages> | Number | 3GPP TS 23.041 [64] CBM Page Parameter bits 0-3 in integer format | | | | | | | | | | |

| Parameter | Type | Description |
|-----------|--------|---|
| <pdu> | String | Protocol data unit: each 8-bit octet is presented as two IRA character long hexadecimal numbers, e.g. octet with integer value 42 is presented to TE as two characters 2A (IRA 50 and 65) |

9.10.4 Notes

SARA-R4 / SARA-N4

- The <stat> parameter is blank in **SMS-STATUS-report** displaying case.

9.11 New message acknowledgement to MT +CNMA

| +CNMA | | | | | | |
|------------|--------------|--------------|----------------|----------------|---------------|-----------------|
| Modules | All products | | | | | |
| Attributes | Syntax | PIN required | Settings saved | Can be aborted | Response time | Error reference |
| | full | Yes | No | No | < 150 s | +CMS Error |

9.11.1 Description

Confirms the reception of a new message (SMS-DELIVER or SMS-STATUS-REPORT) which is routed directly to the TE (see the +CNMI command). This acknowledgement command shall be used when +CSMS parameter <service> equals 1. The MT shall not send another +CMT or +CDS (see the +CNMI command) unsolicited result codes to the TE before the previous one is acknowledged. If the MT does not get acknowledgement within required time (network timeout), the MT should respond as specified in 3GPP TS 24.011 [68] to the network. The MT shall automatically disable routing to the TE by setting both <mt> and <ds> values of +CNMI to zero. If the command is executed, but no acknowledgement is expected, or some other MT related error occurs, the +CMS ERROR: <err> error result code is returned.

In PDU mode, it is possible to send either positive (RP-ACK) or negative (RP-ERROR) acknowledgement to the network. The <n> parameter defines which one will be sent. Optionally (when <length> is greater than zero) an acknowledgement TPDU (SMS-DELIVER-REPORT for RP-ACK or RP-ERROR) may be sent to the network. The entering of PDU is done similarly as specified in +CMGS command, except that the format of <ackpdu> is used instead of <pdu> (i.e. SMSC address field is not present). The PDU shall not be bounded by double quotes.



SARA-R4 / SARA-N4

The MT returns the "OK" final result code even if no acknowledgement is expected.

9.11.2 Syntax

| Type | Syntax | Response | Example |
|------|---|---|---|
| Set | Text mode (+CMGF=1): AT+CNMA | OK | AT+CNMA OK |
| | PDU mode (+CMGF=0): AT+CNMA[=<n>[,<length> [PDU is given<Ctrl-Z>/<ESC>]]] | OK | AT+CNMA=1,5 >0007000000 <Ctrl-Z> OK |
| Test | AT+CNMA=? | Text mode (+CMGF=1): OK | OK |
| | | PDU mode (+CMGF=0): +CNMA: (list of supported <n>s) | +CNMA: (0-2) OK |
| | | OK | OK |

9.11.3 Defined values

| Parameter | Type | Description |
|-----------|--------|--|
| <n> | Number | Allowed values: <ul style="list-style-type: none"> 0: the command operates similarly as defined for the text mode 1: sends RP-ACK (or buffered result code received correctly) 2: sends RP-ERROR (if PDU is not given, ME/TA shall send SMS-DELIVER-REPORT with 3GPP TS 23.040 [63] TP-FCS value set to 'FF' (unspecified error cause)) |
| <length> | Number | PDU's length in octets without the Service Center's address |

9.12 List message +CMGL

| +CMGL | | | | | | |
|-------------------|---------------|---------------------|-----------------------|-----------------------|--|------------------------|
| Modules | All products | | | | | |
| Attributes | Syntax | PIN required | Settings saved | Can be aborted | Response time | Error reference |
| | full | Yes | No | No | Up to 3 min (<1 s for prompt ">" when present) | +CMS Error |

9.12.1 Description

Returns SMS messages with status value <stat> from message storage <mem1> to the DTE. If status of the received message is "received unread", status in the storage changes to "received read".

9.12.2 Syntax

| Type | Syntax | Response | Example |
|------|---|--|---|
| Set | Text mode (+CMGF=1): AT+CMGL[=<stat>] | Command successful and SMS-DELIVERs: +CMGL: <index>,<stat>,<oa>,[<alpha>],[<scts>],[<tooa>,<length>] <data> [+CMGL: <index>,<stat>,<oa>,[<alpha>],[<scts>],[<tooa>,<length>]<data>[...]] OK | AT+CMGL +CMGL: 303,"REC READ","+393401234999",,"08/08/06,10:01:38+08" You have a missed called. Free information provided by your operator. OK |
| | | Command successful and SMS-SUBMITs: +CMGL: <index>,<stat>,<da>,[<alpha>],[<toda>,<length>] <data> [+CMGL: <index>,<stat>,<da>,[<alpha>],[<toda>,<length>]<data>[...]] OK | |
| | | Command successful and SMS-STATUS-REPORTs: +CMGL: <index>,<stat>,<fo>,<mr>,[<ra>],[<tora>],[<scts>,<dt>,<st>] [+CMGL: <index>,<stat>,<fo>,<mr>,[<ra>],[<tora>],[<scts>,<dt>,<st>[...]] OK | |
| | | Command successful and SMS-COMMANDs: +CMGL: <index>,<stat>,<fo>,<ct> [+CMGL: <index>,<stat>,<fo>,<ct>[...]] OK | |
| | | Command successful and CBM storage: +CMGL: <index>,<stat>,<sn>,<mid>,<page>,<pages><data> [+CMGL: <index>,<stat>,<sn>,<mid>,<page>,<pages>,<data>[...]] OK | |
| | PDU mode (+CMGF=0): AT+CMGL[=<stat>] | Command successful: | AT+CMGL=1 |

| Type | Syntax | Response | Example |
|------|-----------|--|--|
| | | +CMGL: <index>,<stat>,<alpha>],<length> <pdu> | +CMGL: 305,1,,57 079193432900 1185440ED0D637396C7EBBCB0 000909092708024802A050 003000303DEA0584CE60 |
| | | [+CMGL: <index>,<stat>,<alpha>],<length>] <pdu> [...] | 205D974791994769BDF3A90 DB759687E9F534FD0DA2C9603419 OK |
| Test | AT+CMGL=? | +CMGL: (list of supported <stat>s) OK | +CMGL: ("REC UNREAD","REC READ","STO UNSENT","STO SENT", "ALL") OK |

9.12.3 Defined values

| Parameter | Type | Description |
|-----------|------------------|--|
| <stat> | Number or String | Number type in PDU mode (default value: 4), or string type in text mode (default value: "ALL"); indicates the status of message in memory: <ul style="list-style-type: none"> • 0: in PDU mode or "REC UNREAD" in text mode: received unread SMS messages • 1: in PDU mode or "REC READ" in text mode: received read SMS messages • 2: in PDU mode or "STO UNSENT" in text mode: stored unsend SMS messages • 3: in PDU mode or "STO SENT" in text mode: stored sent SMS messages • 4: in PDU mode or "ALL" in text mode: all SMS messages |
| <index> | Number | Storage position |
| <oa> | String | Originator address |
| <alpha> | String | Alphanumeric representation of <da> or <oa> corresponding to the entry found in the phonebook 3GPP TS 24.008 [67]. The parameter is not managed. |
| <scts> | String | Service center time stamp in time-string format; see the <dt> parameter |
| <tooa> | Number | Type of address of <oa> - octet |
| <length> | Number | Two meanings: <ul style="list-style-type: none"> • in text mode: number of characters • in PDU mode: PDU's length in octets without the Service Center's address. In example 039121430100038166F6000004E374F80D: this is a PDU with Service Center's number +1234, that generates the address 03912143 (4 octets). Thus in this case <length> = 13. |
| <data> | String | This is the TP-User-Data in text mode; the decoding depends on the DCS (Data Coding Scheme) and the FO (First Octet) of the SMS header 3GPP TS 23.040 [63]; format: <ul style="list-style-type: none"> • if DCS indicates that 3GPP TS 23.038 [62] GSM 7 bit default alphabet is used: <ul style="list-style-type: none"> o if TE character set other than "HEX" (see the +CSCS AT command description): ME/TA converts GSM alphabet into current TE character set according to rules of Annex A o if TE character set is "HEX": ME/TA converts each 7-bit character of GSM 7 bit default alphabet into two IRA character long hexadecimal number (e.g. character Æ (GSM 7 bit default alphabet 28) is presented as 1C (IRA 49 and 67)) • if DCS indicates that 8-bit or UCS2 data coding scheme is used: ME/TA converts each 8-bit octet into two IRA character long hexadecimal number (e.g. octet with integer value 42 is presented to TE as two characters 2A (IRA 50 and 65)) In the case of CBS: 3GPP TS 23.041 [64] CBM Content of Message in text mode responses; format: <ul style="list-style-type: none"> • if DCS indicates that 3GPP TS 23.038 [62] GSM 7 bit default alphabet is used: <ul style="list-style-type: none"> o if TE character set other than "HEX" (see the +CSCS AT command description): ME/TA converts GSM alphabet into current TE character set according to rules of Annex A o if TE character set is "HEX": ME/TA converts each 7-bit character of the GSM 7 bit default alphabet into two IRA character long hexadecimal number if DCS indicates that 8-bit or UCS2 data coding scheme is used: ME/TA converts each 8-bit octet into two IRA character long hexadecimal number |
| <da> | String | Destination address |
| <toda> | Number | Type of address of <da> - octet |
| <fo> | Number | First octet of the SMS TPDU (see 3GPP TS 23.040 [63]) |

| Parameter | Type | Description |
|-----------|--------|---|
| <mr> | Number | Message reference |
| <ra> | String | Recipient address field |
| <tora> | Number | Type of address of <ra> - octet |
| <dt> | String | Discharge time in format "yy/MM/dd,hh:mm:ss+zz"; the time zone is expressed in steps of 15 minutes. The range goes from -48 to +56 |
| <st> | Number | Status of an SMS STATUS-REPORT |
| <ct> | Number | TP-Command-Type (default 0) |
| <sn> | Number | CBM serial number |
| <mid> | Number | CBM message identifier |
| <page> | Number | 3GPP TS 23.041 [64] CBM Page Parameter bits 4-7 in integer format |
| <pages> | Number | 3GPP TS 23.041 [64] CBM Page Parameter bits 0-3 in integer format |
| <pdu> | String | Protocol data unit: each 8-bit octet is presented as two IRA character long hexadecimal numbers, e.g. octet with integer value 42 is presented to TE as two characters 2A (IRA 50 and 65) |
| <dc> | Number | Data Coding Scheme |

9.12.4 Notes

SARA-R4 / SARA-N4

- When parameter <stat> is omitted, the default value will be 0 (if PDU mode is active) or "REC UNREAD" (if text mode is active).
- The <stat> parameter is blank in **SMS-STATUS-report** displaying case.

9.13 Send message +CMGS

| +CMGS | | | | | | |
|------------|--------------|--------------|----------------|----------------|---|-----------------|
| Modules | All products | | | | | |
| Attributes | Syntax | PIN required | Settings saved | Can be aborted | Response time | Error reference |
| | full | Yes | No | No | Up to 3 min (<1s for prompt ">" when present) | +CMS Error |

9.13.1 Description

Sends a message from a DTE to the network (SMS-SUBMIT). The message reference value <mr> is returned to the DTE for a successful message delivery. Optionally (when enabled by **+CSMS** AT command and the network supports) <ackpdu> is returned. Values can be used to identify message upon unsolicited delivery status report result code. <Ctrl-Z> indicates that the SMS shall be sent, while <ESC> indicates aborting of the edited SMS.



The entered text/PDU is preceded by a ">" (Greater-Than sign) character, and this indicates that the interface is in "text/PDU enter" mode. The DCD signal shall be in ON state while the text/PDU is entered.

9.13.2 Syntax

| Type | Syntax | Response | Example |
|------|---|----------------------------------|---|
| Set | Text mode (+CMGF=1): AT+CMGS=<da>[,<toda>]<CR> > text is entered<Ctrl-Z/ESC> | +CMGS: <mr> OK | AT+CMGS="0171112233"<CR> > This is the text<Ctrl-Z> +CMGS: 2 OK |
| | PDU mode (+CMGF=0): AT+CMGS=<length><CR> > PDU is given<Ctrl-Z/ESC> | +CMGS: <mr>[,<ackpdu>] OK | AT+CMGS=13<CR> > 039121430100038166F60000 4E374F80D<Ctrl-Z> +CMGS: 2 OK |
| Test | AT+CMGS=? | OK | |

9.13.3 Defined values

| Parameter | Type | Description |
|-----------|--------|--|
| <da> | String | Destination address |
| <toa> | Number | Type of address of <da> - octet |
| <text> | String | SMS String |
| <mr> | Number | Message reference |
| <length> | Number | Two meanings: <ul style="list-style-type: none"> in text mode: number of characters in PDU mode: PDU's length in octets without the Service Center's address. In example 039121430100038166F6000004E374F80D: is a PDU with Service Center's number +1234, that generates the address 03912143 (4 octets). Thus in this case <length>=13. |
| <PDU> | String | Protocol Data Unit: each 8-bit octet of the PDU must be written as two IRA character long hexadecimal numbers, e.g. octet with integer value 42 must be written as two characters 2A (IRA 50 and 65) |
| <ackpdu> | String | See the 3GPP TS 23.040 [63] RP-User-Data element of RP-ACK PDU; the format is same as for <PDU> in case of SMS |

9.13.4 Notes

SARA-R4 / SARA-N4

- The <ackpdu> parameter is not supported.

9.14 Write message to memory +CMGW

| +CMGW | | | | | | |
|------------|--------------|--------------|----------------|----------------|---------------|-----------------|
| Modules | All products | | | | | |
| Attributes | Syntax | PIN required | Settings saved | Can be aborted | Response time | Error reference |
| | full | Yes | No | No | <10 s | +CMS Error |

9.14.1 Description

Stores a message (SMS-DELIVER or SMS-SUBMIT) to memory storage <mem2> and returns the memory location <index> of the stored message. <Ctrl-Z> indicates that the SMS shall be stored, while <ESC> indicates aborting of the edited SMS.



The entered text/PDU is preceded by a ">" (Greater-Than sign) character, and this indicates that the interface is in "text/PDU enter" mode. The DCD signal shall be in ON state while the text/PDU is entered.

9.14.2 Syntax

| Type | Syntax | Response | Example |
|------|---|---|--|
| Set | <p>Text mode (+CMGF=1): AT+CMGW[=<oa/da>[,<toa/toda>[,<stat>]]]<CR> text is entered<Ctrl-Z/ESC></p> <p>PDU mode (+CMGF=0): AT+CMGW=<length>[,<stat>]<CR> PDU is given<Ctrl-Z/ESC></p> | <p>+CMGW: <index> OK</p> <p>+CMGW: <index> OK</p> | <p>AT+CMGW="091137880"<CR> > This is the text<Ctrl-Z> +CMGW: 303 OK</p> <p>AT+CMGW=13<CR> > 039121430100038166F600000 4E374F80D<Ctrl-Z> +CMGW: 303 OK</p> |
| Test | AT+CMGW=? | OK | |

9.14.3 Defined values

| Parameter | Type | Description |
|-----------|--------|--|
| <da> | String | TP-Destination-Address Address-Value field (see the 3GPP TS 23.040 [63]); BCD numbers (or GSM 7 bit default alphabet characters) are converted to characters |

| Parameter | Type | Description |
|-----------|------------------|--|
| | | of the currently selected TE character set (see the +CSCS AT command); type of address given by <toa> |
| <oa> | String | TP-Originating-Address Address-Value field (see the 3GPP TS 23.040 [63]); BCD numbers (or GSM 7 bit default alphabet characters) are converted to characters of the currently selected TE character set (see the +CSCS AT command); type of address given by <toa> |
| <toa> | Number | TP-Originating-Address Type-of-Address octet (see the 3GPP TS 24.011 [68]); see the <toa> parameter for the default value |
| <toa> | Number | TP-Destination-Address Type-of-Address octet (see the 3GPP TS 24.011 [68]); when the first character of <da> is + (IRA 43) the default value is 145, otherwise it is 129) |
| <stat> | Number or String | Number type in PDU mode (default value: 2), or string type in text mode (default value: "STO UNSENT"); it indicates the message status in memory: <ul style="list-style-type: none"> • 0: in PDU mode or "REC UNREAD" in text mode: received unread SMS messages • 1: in PDU mode or "REC READ" in text mode: received read SMS messages • 2: in PDU mode or "STO UNSENT" in text mode: stored unsend SMS messages • 3: in PDU mode or "STO SENT" in text mode: stored sent SMS messages |
| <text> | String | SMS string |
| <index> | Number | Storage position |
| <length> | Number | The parameter meaning depends on the message format: <ul style="list-style-type: none"> • In text mode: number of characters • In PDU mode: PDU's length in octets without the Service Center's address. In example: 039121430100038166F6000004E374F80D is a PDU with Service Center's number +1234, that generates the address 03912143 (4 octets). Thus in this case <length>=13. |
| <PDU> | String | Protocol Data Unit: each 8-bit octet of the PDU must be written as two IRA character long hexadecimal numbers, e.g. an octet with integer value 42 must be written as two characters 2A (IRA 50 and 65) |

9.15 Send message from storage +CMSS

| +CMSS | | | | | | |
|------------|--------------|--------------|----------------|----------------|---------------|-----------------|
| Modules | All products | | | | | |
| Attributes | Syntax | PIN required | Settings saved | Can be aborted | Response time | Error reference |
| | full | Yes | No | No | Up to 3 min | +CMS Error |

9.15.1 Description

Sends message with location value <index> from the preferred message storage <mem2> to the network (SMS-SUBMIT or SMS-COMMAND). If a new recipient address <da> is given for SMS-SUBMIT, it will be used instead of the one stored with the message. Reference value <mr> is returned to the DTE on successful message delivery.

9.15.2 Syntax

| Type | Syntax | Response | Example |
|------|---|-------------------|---------------------------------------|
| Set | Text mode (+CMGF=1): AT+CMSS=<index>[,<da>[,<toa>]] | +CMSS: <mr> OK | AT+CMSS=302 +CMSS: 3 OK |
| | PDU mode (+CMGF=0): AT+CMSS=<index> | +CMSS: <mr> OK | AT+CMSS=302 +CMSS: 4 OK |
| Test | AT+CMSS=? | OK | |

9.15.3 Defined values

| Parameter | Type | Description |
|-----------|--------|---------------------|
| <index> | Number | Storage position |
| <da> | String | Destination address |

| Parameter | Type | Description |
|-----------|--------|---------------------------------|
| <tda> | Number | Type of address of <da> - octet |
| <mr> | Number | Message reference |

9.16 Set text mode parameters +CSMP

| +CSMP | | | | | | |
|------------|--------------|--------------|----------------|----------------|---------------|-----------------|
| Modules | All products | | | | | |
| Attributes | Syntax | PIN required | Settings saved | Can be aborted | Response time | Error reference |
| | full | Yes | +CSAS | No | < 10 s | +CMS Error |

9.16.1 Description

Selects values for additional parameters needed when an SMS is sent to the network or placed in a storage when text format message mode is selected. For more details see the 3GPP TS 23.038 [62] and the 3GPP TS 23.040 [63].

9.16.2 Syntax

| Type | Syntax | Response | Example |
|------|----------------------------------|-----------------------------------|--------------------------|
| Set | AT+CSMP=<fo>,<vp>[,<pid>[,<dc>]] | OK | AT+CSMP=17,167,0,0 OK |
| Read | AT+CSMP? | +CSMP: <fo>,<vp>,<pid>,<dc> OK | +CSMP: 17,167,0,0 OK |
| Test | AT+CSMP=? | OK | |

9.16.3 Defined values

| Parameter | Type | Description | | | | | | | | | | | | | | | | | | | | | | | | | |
|------------|---|---|-------|-------|--------|---|---|-----------------------------|---|---|--|---|---|----------|---|---|--|------|-----------------------|----------|---|------------|--|------------|-----------------------|------------|------------------------|
| <fo> | Number | First octet of the SMS TPDU (see 3GPP TS 23.040 [63]) | | | | | | | | | | | | | | | | | | | | | | | | | |
| <vp> | Number | Format depending on the values of the bit3/bit4 of the <fo> (SMS-SUBMIT case): <table border="1" data-bbox="542 1176 1433 1388"> <thead> <tr> <th>Bit 3</th> <th>Bit 4</th> <th>Format</th> </tr> </thead> <tbody> <tr> <td>0</td> <td>0</td> <td>Validity period not present</td> </tr> <tr> <td>0</td> <td>1</td> <td>Validity period present, relative format</td> </tr> <tr> <td>1</td> <td>0</td> <td>Reserved</td> </tr> <tr> <td>1</td> <td>1</td> <td>Validity period present, absolute format</td> </tr> </tbody> </table> <ul style="list-style-type: none"> Relative format: validity period, counted from when the SMS-SUBMIT is received by the SMSC, in range 0-255 (the default value is 167); for more details see the 3GPP TS 23.040 [63] <table border="1" data-bbox="582 1489 1433 1668"> <thead> <tr> <th><vp></th> <th>Validity period value</th> </tr> </thead> <tbody> <tr> <td>0 to 143</td> <td>(TP-VP + 1) x 5 minutes (i.e. 5 minutes intervals up to 12 hours)</td> </tr> <tr> <td>144 to 167</td> <td>12 hours + ((TP-VP -143) x 30 minutes)</td> </tr> <tr> <td>168 to 196</td> <td>(TP-VP - 166) x 1 day</td> </tr> <tr> <td>197 to 255</td> <td>(TP-VP - 192) x 1 week</td> </tr> </tbody> </table> Absolute format: absolute time of the validity period termination in string format ("yy/MM/dd,hh:mm:ss+zz") (see the 3GPP TS 23.040 [63]); the time zone is expressed in steps of 15 minutes. The range goes from -48 to +56 | Bit 3 | Bit 4 | Format | 0 | 0 | Validity period not present | 0 | 1 | Validity period present, relative format | 1 | 0 | Reserved | 1 | 1 | Validity period present, absolute format | <vp> | Validity period value | 0 to 143 | (TP-VP + 1) x 5 minutes (i.e. 5 minutes intervals up to 12 hours) | 144 to 167 | 12 hours + ((TP-VP -143) x 30 minutes) | 168 to 196 | (TP-VP - 166) x 1 day | 197 to 255 | (TP-VP - 192) x 1 week |
| Bit 3 | Bit 4 | Format | | | | | | | | | | | | | | | | | | | | | | | | | |
| 0 | 0 | Validity period not present | | | | | | | | | | | | | | | | | | | | | | | | | |
| 0 | 1 | Validity period present, relative format | | | | | | | | | | | | | | | | | | | | | | | | | |
| 1 | 0 | Reserved | | | | | | | | | | | | | | | | | | | | | | | | | |
| 1 | 1 | Validity period present, absolute format | | | | | | | | | | | | | | | | | | | | | | | | | |
| <vp> | Validity period value | | | | | | | | | | | | | | | | | | | | | | | | | | |
| 0 to 143 | (TP-VP + 1) x 5 minutes (i.e. 5 minutes intervals up to 12 hours) | | | | | | | | | | | | | | | | | | | | | | | | | | |
| 144 to 167 | 12 hours + ((TP-VP -143) x 30 minutes) | | | | | | | | | | | | | | | | | | | | | | | | | | |
| 168 to 196 | (TP-VP - 166) x 1 day | | | | | | | | | | | | | | | | | | | | | | | | | | |
| 197 to 255 | (TP-VP - 192) x 1 week | | | | | | | | | | | | | | | | | | | | | | | | | | |
| <pid> | Number | TP-Protocol-Identifier (default value: 0); see the 3GPP TS 23.040 [63] | | | | | | | | | | | | | | | | | | | | | | | | | |
| <dc> | Number | Data Coding Scheme. The default value is 0 | | | | | | | | | | | | | | | | | | | | | | | | | |

9.17 Delete message +CMGD

| +CMGD | | | | | | |
|-------------------|---------------|---------------------|-----------------------|-----------------------|----------------------|------------------------|
| Modules | All products | | | | | |
| Attributes | Syntax | PIN required | Settings saved | Can be aborted | Response time | Error reference |
| | partial | Yes | No | No | < 55 s | +CMS Error |

9.17.1 Description

Deletes the message from the preferred message storage <mem1>, if <flag>=0 or not present, in location <index>. Otherwise the messages are deleted following the rules specified by <flag>.

If the <index> value is out of range (it depends on [AT+CPMS](#) command setting), then the "+CMS ERROR: Invalid memory index" error result code is returned.

SARA-R4 / SARA-N4
When deleting a message from an empty location, the module returns the "+CMS ERROR: Invalid memory index" error result code.

9.17.2 Syntax

| Type | Syntax | Response | Example |
|------|--------------------------|---|----------------------------|
| Set | AT+CMGD=<index>[,<flag>] | OK | AT+CMGD=3 OK |
| Test | AT+CMGD=? | +CMGD: (list of supported <index>s),(list of supported <flag>s) OK | +CMGD: (1-350),(0-4) OK |

9.17.3 Defined values

| Parameter | Type | Description |
|-----------|--------|--|
| <index> | Number | Storage position |
| <flag> | Number | Deletion flag. If present, and different from 0, the <index> parameter is ignored: <ul style="list-style-type: none"> 0 (default value): delete the message specified in <index> 1: delete all the read messages from the preferred message storage, leaving unread messages and stored mobile originated messages (whether sent or not) untouched 2: delete all the read messages from the preferred message storage and sent mobile originated messages, leaving unread messages and unsent mobile originated messages untouched 3: delete all the read messages from the preferred message storage, sent and unsent mobile originated messages leaving unread messages untouched 4: delete all the messages from the preferred message storage including unread messages |

9.18 Service center address +CSCA

| +CSCA | | | | | | |
|-------------------|---------------|---------------------|-----------------------|-----------------------|----------------------|------------------------|
| Modules | All products | | | | | |
| Attributes | Syntax | PIN required | Settings saved | Can be aborted | Response time | Error reference |
| | full | Yes | +CSAS | No | < 10 s | +CMS Error |

9.18.1 Description

Updates the SMSC address, through which mobile originated SMSes are transmitted. In text mode the setting is used by send and write commands. In PDU mode the setting is used by the same commands, but only when the length of SMSC address coded into <pdu> parameter equals zero.

SARA-R4 / SARA-N4
This command sets the service center value both in the RAM (this value is actually the SMSC address used) and in the SIM card. Through the read command the value of current service center stored in the RAM is displayed. At the power on, the MT reads the SMSC address in the SIM card and the same value is set in RAM.

9.18.2 Syntax

| Type | Syntax | Response | Example |
|------|-------------------------|----------------------------|--------------------------------|
| Set | AT+CSCA=<sca>[,<tosca>] | OK | AT+CSCA="0170111000",129 OK |
| Read | AT+CSCA? | +CSCA: <sca>,<tosca> OK | +CSCA: "",129 OK |
| Test | AT+CSCA=? | OK | |

9.18.3 Defined values

| Parameter | Type | Description |
|-----------|--------|--|
| <sca> | String | Service center address. |
| <tosca> | String | Type of address of <sca> (for more details refer to 3GPP TS 24.008 [67]); the default value is 145 when string includes '+', otherwise the default is 129. |

9.19 Read concatenated message +UCMGR

| +UCMGR | | | | | | |
|-------------------|---|---------------------|-----------------------|-----------------------|----------------------|------------------------|
| Modules | SARA-R410M-02B SARA-R410M-52B SARA-R410M-63B SARA-R410M-73B SARA-R410M-83B SARA-R412M SARA-R422 SARA-R422M8S SARA-R422S SARA-N4 | | | | | |
| Attributes | Syntax | PIN required | Settings saved | Can be aborted | Response time | Error reference |
| | full | Yes | No | No | <10 s | +CMS Error |

9.19.1 Description

Returns the message with location value <index> from message storage <mem1> to the DTE and shows additional information when the message is a segment of a concatenated one:

- SMS-DELIVER: the parameters <tooa>, <fo>, <pid>, <dcs>, <sca>, <tosca>, <length> shall be displayed only if **+CSDH: 1**.
- SMS-SUBMIT: the parameters <toda>, <fo>, <pid>, <dcs>, <vp>, <sca>, <tosca>, <length> shall be displayed only if **+CSDH: 1**.
- SMS-COMMAND: <pid>, <mn>, <da>, <toda>, <length>, <cdata> shall be displayed only if **+CSDH: 1**.

The syntax AT+UCMGR=0 allows to display an SMS class 0 if it is signaled to MT, because no MMI is available in the MT (see also the **+CNMI** AT command notes).

If the received message status is "received unread", the status in the storage changes to "received read".

The command is supported only for text mode (**+CMGF: 1**).

If the <index> value is out of range (it depends on the preferred message storage, **+CPMS** command, settings) or it refers to an empty position, then the "+CMS ERROR: invalid memory index" error result code is returned.

9.19.2 Syntax

| Type | Syntax | Response | Example |
|------|------------------|--|---|
| Set | AT+UCMGR=<index> | SMS-DELIVER +UCMGR: <stat>,<oa>,[<alpha>], <scts>[,<tooa>, <fo>,<pid>,<dcs>, <sca>,<tosca>,<length>][,<seq>, <max>,<iei>,<ref>] <data> OK | AT+UCMGR=1 +UCMGR: "REC READ", "+393488535999", "07/04/05,18:0 2:28+08",145,4,0,0,"+393492000 466",145,153,1,2,0,127 u-blox reserves all rights to this document and the information contained herein. Reproduction, use or disclosure to third parties without express permis |
| | | SMS-SUBMIT +UCMGR: <stat>,<da>,[<alpha>] [<toda>,<fo>,<pid>,<dcs>,[<vp>], <sca>,<tosca>,<length>][,<seq>, <max>,<iei>,<ref>] | OK |

| Type | Syntax | Response | Example |
|------|------------|--|---------|
| | | <data> OK SMS-STATUS-report +UCMGR: <stat>,<fo>,<mr>,[<ra>], [<tora>]<scts><dt>,<st> OK SMS-COMMAND +UCMGR: <stat>,<fo>,<ct>[,<pid>, [<mn>],[<da>],[<toda>],<length> [<cdata>]] OK CBM storage +UCMGR: <stat>,<sn>,<mid>, <dcs>,<page>,<pages> <data> OK | |
| Test | AT+UCMGR=? | OK | |

9.19.3 Defined values

| Parameter | Type | Description |
|-----------|--------|--|
| <index> | Number | Storage position |
| <stat> | String | Indicates the status of message in memory: <ul style="list-style-type: none"> • "REC UNREAD": received unread SMS • "REC READ": received read SMS • "STO UNSENT": stored unsent SMS • "STO SENT": stored sent SMS |
| <oa> | String | Originator address |
| <alpha> | String | Alphanumeric representation of <da> or <oa> corresponding to the entry found in the phonebook 3GPP TS 24.008 [67]. The parameter is not managed. |
| <scts> | String | Service center time stamp in time-string format, refer to <dt> |
| <tooa> | Number | Type of address of <oa> - octet |
| <fo> | Number | First octet of the SMS TPDU (see 3GPP TS 23.040 [63]) |
| <pid> | Number | TP-Protocol-Identifier (default 0); see 3GPP TS 23.040 [63] |
| <dcs> | Number | Data Coding Scheme |
| <sca> | String | Service center address field |
| <tosca> | Number | Type of address of <sca> - octet in Number format (for more details see 3GPP TS 24.008 [67]); default 145 when string includes '+', otherwise default 129 |
| <length> | Number | Number of characters |
| <seq> | Number | Sequence number of the current short message (1-255) |
| <max> | Number | Maximum number of short messages in the concatenated short message (1-255) |
| <iei> | Number | Information Element Identifier, the possible values are the following: <ul style="list-style-type: none"> • 0: Concatenated short messages, 8-bit reference number • 8: Concatenated short messages, 16-bit reference number |
| <ref> | Number | Concatenated short message reference number: <ul style="list-style-type: none"> • 0-255: concatenated short messages, 8-bit reference number case • 0-65535: concatenated short messages, 16-bit reference number case |
| <data> | String | In the case of SMS: 3GPP TS 23.040 [63] TP-User-Data in text mode responses; format: <ul style="list-style-type: none"> • if <dcs> indicates that 3GPP TS 23.038 [62] GSM 7 bit default alphabet is used: <ul style="list-style-type: none"> o if TE character set other than "HEX" (see the +CSCS AT command description): ME/TA converts GSM alphabet into current TE character set according to rules of 3GPP TS 27.005 [69] Annex A o if TE character set is "HEX": ME/TA converts each 7-bit character of GSM 7 bit default alphabet into two IRA character long hexadecimal number (e.g. character Æ (GSM 7 bit default alphabet 28) is presented as 1C (IRA 49 and 67)) |

| Parameter | Type | Description | | | | | | | | | | |
|------------|---|--|------|-----------------------|----------|---|------------|--|------------|-----------------------|------------|------------------------|
| | | <ul style="list-style-type: none"> if <dc> indicates that 8-bit or UCS2 data coding scheme is used: ME/TA converts each 8-bit octet into two IRA character long hexadecimal number (e.g. octet with integer value 42 is presented to TE as two characters 2A (IRA 50 and 65)) <p>In the case of CBS: 3GPP TS 23.041 [64] CBM Content of Message in text mode responses; format:</p> <ul style="list-style-type: none"> if <dc> indicates that 3GPP TS 23.038 [62] GSM 7 bit default alphabet is used: <ul style="list-style-type: none"> if TE character set other than "HEX" (see the +CSCS AT command description): ME/TA converts GSM alphabet into current TE character set according to rules of 3GPP TS 27.005 [69] Annex A if TE character set is "HEX": ME/TA converts each 7-bit character of the GSM 7 bit default alphabet into two IRA character long hexadecimal number <p>if <dc> indicates that 8-bit or UCS2 data coding scheme is used: ME/TA converts each 8-bit octet into two IRA character long hexadecimal number</p> | | | | | | | | | | |
| <da> | String | Destination address | | | | | | | | | | |
| <tda> | Number | Type of address of <da> - octet | | | | | | | | | | |
| <vp> | Number | <p>Format depending of the <fo> setting:</p> <ul style="list-style-type: none"> Relative format: validity period starting from when the SMS is received by the SMSC, in range 0-255 (default value 167); for more details see 3GPP TS 23.040 [63] <table border="1"> <thead> <tr> <th><vp></th> <th>Validity period value</th> </tr> </thead> <tbody> <tr> <td>0 to 143</td> <td>(TP-VP + 1) x 5 minutes (i.e. 5 minutes intervals up to 12 hours)</td> </tr> <tr> <td>144 to 167</td> <td>12 hours + ((TP-VP -143) x 30 minutes)</td> </tr> <tr> <td>168 to 196</td> <td>(TP-VP - 166) x 1 day</td> </tr> <tr> <td>197 to 255</td> <td>(TP-VP - 192) x 1 week</td> </tr> </tbody> </table> <ul style="list-style-type: none"> Absolute format: absolute time of the validity period termination in string format ("yy/MM/dd,hh:mm:ss+zz") (refer to 3GPP TS 23.040 [63]); the time zone is expressed in steps of 15 minutes. The range goes from -48 to +56 | <vp> | Validity period value | 0 to 143 | (TP-VP + 1) x 5 minutes (i.e. 5 minutes intervals up to 12 hours) | 144 to 167 | 12 hours + ((TP-VP -143) x 30 minutes) | 168 to 196 | (TP-VP - 166) x 1 day | 197 to 255 | (TP-VP - 192) x 1 week |
| <vp> | Validity period value | | | | | | | | | | | |
| 0 to 143 | (TP-VP + 1) x 5 minutes (i.e. 5 minutes intervals up to 12 hours) | | | | | | | | | | | |
| 144 to 167 | 12 hours + ((TP-VP -143) x 30 minutes) | | | | | | | | | | | |
| 168 to 196 | (TP-VP - 166) x 1 day | | | | | | | | | | | |
| 197 to 255 | (TP-VP - 192) x 1 week | | | | | | | | | | | |
| <mr> | Number | Message reference | | | | | | | | | | |
| <ra> | String | Recipient address field | | | | | | | | | | |
| <tora> | Number | Type of address of <ra> - octet | | | | | | | | | | |
| <scts> | String | Service center time stamp in time-string format, refer to <dt> | | | | | | | | | | |
| <dt> | String | Discharge time in format "yy/MM/dd,hh:mm:ss+zz"; the time zone is expressed in steps of 15 minutes. The range goes from -48 to +56 | | | | | | | | | | |
| <st> | Number | Status of an SMS STATUS-REPORT | | | | | | | | | | |
| <ct> | Number | TP-Command-Type (default 0) | | | | | | | | | | |
| <mn> | Number | 3GPP TS 23.040 [63] TP-Message-Number in integer format | | | | | | | | | | |
| <mid> | Number | CBM message identifier | | | | | | | | | | |
| <cdata> | String | TP-Command-Data in text mode responses | | | | | | | | | | |
| <sn> | Number | CBM serial number | | | | | | | | | | |
| <page> | Number | 3GPP TS 23.041 [64] CBM page parameter bits 4-7 in integer format | | | | | | | | | | |
| <pages> | Number | 3GPP TS 23.041 [64] CBM page parameter bits 0-3 in integer format | | | | | | | | | | |

9.19.4 Notes

SARA-R4 / SARA-N4

- The <stat> parameter is blank in **SMS-STATUS-report** displaying case.

9.20 List concatenated message +UCMGL

| +UCMGL | | | | | | |
|-------------------|---|---------------------|-----------------------|-----------------------|---|------------------------|
| Modules | SARA-R410M-02B SARA-R410M-52B SARA-R410M-63B SARA-R410M-73B SARA-R410M-83B SARA-R412M SARA-R422 SARA-R422M8S SARA-R422S SARA-N4 | | | | | |
| Attributes | Syntax | PIN required | Settings saved | Can be aborted | Response time | Error reference |
| | full | Yes | No | No | Up to 3 min (<1s for prompt ">" when present) | +CMS Error |

9.20.1 Description

Returns SMS messages with status value <stat> from message storage <mem1> to the DTE and shows additional information when the message is a segment of a concatenated one:

- SMS-DELIVER: the parameters <tooa>, <length> shall be displayed only if [+CSDH: 1](#).
- SMS-SUBMIT: the parameters <toda>, <length> shall be displayed only if [+CSDH: 1](#).



If status of the received message is "received unread", status in the storage changes to "received read".



The command is supported only for text mode ([+CMGF: 1](#)).

9.20.2 Syntax

| Type | Syntax | Response | Example |
|------|-------------------|--|---|
| Set | AT+UCMGL[=<stat>] | <p>SMS-DELIVERs: +UCMGL: <index>,<stat>,<oa>, [<alpha>],[<scts>],[<tooa>, <length>],[<seq>,<max>,<iei>, <ref>] <data> [+UCMGL: <index>,<stat>,<oa>, [<alpha>],[<scts>],[<tooa>, <length>],[<seq>,<max>,<iei>, <ref>]<data>[...]] OK</p> <p>SMS-SUBMITs: +UCMGL: <index>,<stat>,<da>, [<alpha>],[<toda>,<length>],[<seq>,<max>,<iei>,<ref>] <data> [+UCMGL: <index>,<stat>,<da>, [<alpha>],[<toda>,<length>],[<seq>, <max>,<iei>,<ref>]<data>[...]] OK</p> <p>SMS-STATUS-REPORTs: +UCMGL: <index>,<stat>,<fo>, <mr>,<ra>],[<tora>],[<scts>,<dt>, <st> [+UCMGL: <index>,<stat>,<fo>, <mr>,<ra>],[<tora>],[<scts>,<dt>, <st> [...]] OK</p> <p>SMS-COMMANDs: +UCMGL: <index>,<stat>,<fo>,<ct></p> | <p>AT+UCMGL +UCMGL: 304,"REC READ","+39340 1234999","08/08/06,10:01:38+08", 145,152,1,2,8,32767 u-blox reserves all rights to this document and the information contained herein. Reproduction, use or disclosure to third parties without express permi +UCMGL: 305,"REC READ","+39340 1234999","08/08/06,10:01:40+08", 145,29,2,2,8,32767 ssion is strictly prohibited. OK</p> |

| Type | Syntax | Response | Example |
|------|------------|---|--|
| | | [+UCMGL: <index>,<stat>,<fo>,<ct>[...]] OK | |
| | | CBM storage: +UCMGL: <index>,<stat>,<sn>,<mid>,<page>,<pages><data> [+UCMGL: <index>,<stat>,<sn>,<mid>,<page>,<pages>,<data>[...]] OK | |
| Test | AT+UCMGL=? | +UCMGL: (list of supported <stat>s) OK | +UCMGL: ("REC UNREAD","REC READ","STO UNSENT","STO SENT","ALL ") OK |

9.20.3 Defined values

| Parameter | Type | Description |
|-----------|--------|---|
| <stat> | String | Indicates the status of message in memory: <ul style="list-style-type: none"> "REC UNREAD": received unread SMS messages "REC READ": received read SMS messages "STO UNSENT": stored unsent SMS messages "STO SENT": stored sent SMS messages "ALL": all SMS messages (default value) |
| <index> | Number | Storage position |
| <oa> | String | Originator address |
| <alpha> | String | Alphanumeric representation of <da> or <oa> corresponding to the entry found in the phonebook 3GPP TS 24.008 [67]. The parameter is not managed. |
| <scts> | String | Service center time stamp in time-string format; refer to <dt> |
| <tooa> | Number | Type of address of <oa> - octet |
| <length> | Number | Number of characters |
| <seq> | Number | Sequence number of the current short message (1-255) |
| <max> | Number | Maximum number of short messages in the concatenated short message (1-255) |
| <iei> | Number | Information Element Identifier, the possible values are the following: <ul style="list-style-type: none"> 0: concatenated short messages, 8-bit reference number 8: concatenated short messages, 16-bit reference number |
| <ref> | Number | Concatenated short message reference number: <ul style="list-style-type: none"> 0-255: concatenated short messages, 8-bit reference number case 0-65535: concatenated short messages, 16-bit reference number case |
| <data> | String | In the case of SMS: 3GPP TS 23.040 [63] TP-User-Data in text mode responses; format: <ul style="list-style-type: none"> if <dc> indicates that 3GPP TS 23.038 [62] GSM 7 bit default alphabet is used: <ul style="list-style-type: none"> if TE character set other than "HEX" (see the +CSCS AT command description): ME/TA converts GSM alphabet into current TE character set according to rules of 3GPP TS 27.005 Annex A [69] if TE character set is "HEX": ME/TA converts each 7-bit character of GSM 7 bit default alphabet into two IRA character long hexadecimal number (e.g. character Æ (GSM 7 bit default alphabet 28) is presented as 1C (IRA 49 and 67)) if <dc> indicates that 8-bit or UCS2 data coding scheme is used: ME/TA converts each 8-bit octet into two IRA character long hexadecimal number (e.g. octet with integer value 42 is presented to TE as two characters 2A (IRA 50 and 65)) In the case of CBS: 3GPP TS 23.041 [64] CBM Content of Message in text mode responses; format: <ul style="list-style-type: none"> if <dc> indicates that 3GPP TS 23.038 [62] GSM 7 bit default alphabet is used: <ul style="list-style-type: none"> if TE character set other than "HEX" (see the +CSCS AT command description): ME/TA converts GSM alphabet into current TE character set according to rules of 3GPP TS 27.005 [69] Annex A if TE character set is "HEX": ME/TA converts each 7-bit character of the GSM 7 bit default alphabet into two IRA character long hexadecimal number |

| Parameter | Type | Description |
|-----------|--------|---|
| | | if <dc> indicates that 8-bit or UCS2 data coding scheme is used: ME/TA converts each 8-bit octet into two IRA character long hexadecimal number |
| <da> | String | Destination address |
| <tda> | Number | Type of address of <da> - octet |
| <fo> | Number | First octet of the SMS TPDU (see 3GPP TS 23.040 [63]) |
| <mr> | Number | Message reference |
| <ra> | String | Recipient address field |
| <tora> | Number | Type of address of <ra> - octet |
| <dt> | String | Discharge time in format "yy/MM/dd,hh:mm:ss+zz"; the time zone is expressed in steps of 15 minutes. The range goes from -48 to +56 |
| <st> | Number | Status of an SMS STATUS-REPORT |
| <ct> | Number | TP-Command-Type (default 0) |
| <sn> | Number | CBM serial number |
| <mid> | Number | CBM message identifier |
| <page> | Number | 3GPP TS 23.041 [64] CBM Page Parameter bits 4-7 in integer format |
| <pages> | Number | 3GPP TS 23.041 [64] CBM Page Parameter bits 0-3 in integer format |
| <dc> | Number | Data Coding Scheme |

9.20.4 Notes

SARA-R4 / SARA-N4

- When parameter <stat> is omitted, the default value will be 0 (if PDU mode is active) or "REC UNREAD" (if text mode is active).
- The <stat> parameter is blank in **SMS-STATUS-report** displaying case.

9.21 Send concatenated message +UCMGS

| +UCMGS | | | | | | |
|-------------------|---|---------------------|-----------------------|-----------------------|--|------------------------|
| Modules | SARA-R410M-02B SARA-R410M-52B SARA-R410M-63B SARA-R410M-73B SARA-R410M-83B SARA-R412M SARA-R422 SARA-R422M8S SARA-R422S SARA-N4 | | | | | |
| Attributes | Syntax | PIN required | Settings saved | Can be aborted | Response time | Error reference |
| | full | Yes | No | No | Up to 3 min (<1 s for prompt ">" when present) | +CMS Error |

9.21.1 Description

Sends one segment of a concatenated message from a DTE to the network (SMS-SUBMIT). The message reference value <mr> is returned to the DTE for a successful message delivery. <Ctrl-Z> indicates that the SMS shall be sent, while <ESC> indicates aborting of the edited SMS.

The command is supported only for text mode (+CMGF: 1).

The entered text is preceded by a ">" (Greater-Than sign) character, and this indicates that the interface is in "text enter" mode. The DCD signal shall be in ON state while the text is entered.

9.21.2 Syntax

| Type | Syntax | Response | Example |
|------|--|--------------------|---|
| Set | AT+UCMGS=<da>,[<tda>],[<seq>],<max>,<iei>,<ref><CR> text is entered<Ctrl-Z/ESC> | +UCMGS: <mr> OK | AT+UCMGS="0171112233",,1,2,0,127<CR> > u-blox reserves all rights to this document and the information contained herein. Reproduction, use or disclosure to third parties without express permis<Ctrl-Z> +UCMGS:2 OK |

| Type | Syntax | Response | Example |
|------|------------|----------|--|
| | | | AT+UCMGS="0171112233",,2,2,0, 127<CR> > sion is strictly prohibited.<Ctrl-Z> +UCMGS:3 OK |
| Test | AT+UCMGS=? | OK | |

9.21.3 Defined values

| Parameter | Type | Description |
|-----------|--------|--|
| <da> | String | Destination address |
| <todo> | Number | Type of address of <da> - octet |
| <seq> | Number | Sequence number of the current short message (1-255) |
| <max> | Number | Maximum number of short messages in the concatenated short message (1-255) |
| <iei> | Number | Information Element Identifier, the possible values are the following: <ul style="list-style-type: none"> • 0: Concatenated short messages, 8-bit reference number • 8: Concatenated short messages, 16-bit reference number |
| <ref> | Number | Concatenated short message reference number: <ul style="list-style-type: none"> • 0-255: Concatenated short messages, 8-bit reference number case • 0-65535: Concatenated short messages, 16-bit reference number case |
| <text> | String | SMS String |
| <mr> | Number | Message reference |

9.22 Write concatenated message to memory +UCMGW

| +UCMGW | | | | | | |
|-------------------|---|---------------------|-----------------------|-----------------------|----------------------|------------------------|
| Modules | SARA-R410M-02B SARA-R410M-52B SARA-R410M-63B SARA-R410M-73B SARA-R410M-83B SARA-R412M SARA-R422 SARA-R422M8S SARA-R422S SARA-N4 | | | | | |
| Attributes | Syntax | PIN required | Settings saved | Can be aborted | Response time | Error reference |
| | full | Yes | No | No | < 10 s | +CMS Error |

9.22.1 Description

Stores one segment of a concatenated message (SMS-DELIVER or SMS-SUBMIT) to memory storage <mem2> and returns the memory location <index> of the stored message. <Ctrl-Z> indicates that the SMS shall be stored, while <ESC> indicates aborting of the edited SMS.

The command is supported only for text mode (+CMGF: 1)

The entered text is preceded by a ">" (Greater-Than sign) character, and this indicates that the interface is in "text enter" mode. The DCD signal shall be in ON state while the text is entered.

9.22.2 Syntax

| Type | Syntax | Response | Example |
|------|---|---------------------------|--|
| Set | AT+UCMGW=[<oa/da>],[<tooa/ todo>],[<stat>],[<seq>,<max>,<iei>, <ref><CR> text is entered<Ctrl-Z/ESC> | +UCMGW: <index> OK | AT+UCMGW="091137880",,,1,2,8, 32767<CR> > u-blox reserves all rights to this document and the information contained herein. Reproduction, use or disclosure to third parties without express permi<Ctrl-Z> +UCMGW:302 OK AT+UCMGW="091137880",,,2,2,8, 32767<CR> |

| Type | Syntax | Response | Example |
|------|------------|----------|--|
| | | | > sssion is strictly prohibited.<Ctrl-Z> +UCMGW:303 OK |
| Test | AT+UCMGW=? | OK | |

9.22.3 Defined values

| Parameter | Type | Description |
|-----------|--------|--|
| <da> | String | 3GPP TS 23.040 [63] TP-Destination-Address Address-Value field in string format; BCD numbers (or GSM 7 bit default alphabet characters) are converted to characters of the currently selected TE character set (refer command +CSCS in 3GPP TS 27.007 [58]); type of address given by <toa> |
| <oa> | String | 3GPP TS 23.040 [63] TP-Originating-Address Address-Value field in string format; BCD numbers (or GSM 7 bit default alphabet characters) are converted to characters of the currently selected TE character set (refer command +CSCS chapter Chapter 4.10); type of address given by <toa> |
| <toa> | Number | 3GPP TS 24.011 [68] TP-Originating-Address Type-of-Address octet in integer format (default refer <toa>) |
| <toa> | Number | 3GPP TS 24.011 [68] TP-Destination-Address Type-of-Address octet in integer format (when first character of <da> is + (IRA 43) default is 145, otherwise default is 129) |
| <stat> | String | Indicates the status of message in memory: <ul style="list-style-type: none"> "REC UNREAD": received unread SMS messages "REC READ": received read SMS messages "STO UNSENT": stored unsent SMS messages "STO SENT": stored sent SMS messages (default value) |
| <seq> | Number | Sequence number of the current short message (1-255) |
| <max> | Number | Maximum number of short messages in the concatenated short message (1-255) |
| <iei> | Number | Information Element Identifier, the possible values are the following: <ul style="list-style-type: none"> 0: Concatenated short messages, 8-bit reference number 8: Concatenated short messages, 16-bit reference number |
| <ref> | Number | Concatenated short message reference number: <ul style="list-style-type: none"> 0-255: Concatenated short messages, 8-bit reference number case 0-65535: Concatenated short messages, 16-bit reference number case |
| <text> | String | SMS String |
| <index> | Number | Storage position |

9.23 More messages to send +CMMS

| +CMMS | | | | | | |
|------------|--------------|--------------|----------------|----------------|---------------|-----------------|
| Modules | All products | | | | | |
| Attributes | Syntax | PIN required | Settings saved | Can be aborted | Response time | Error reference |
| | full | Yes | No | No | - | +CMS Error |

9.23.1 Description

Controls the continuity of SMS relay protocol link. When enabled, multiple SMS messages can be sent much faster as link is kept open.

9.23.2 Syntax

| Type | Syntax | Response | Example |
|------|------------------|--|--------------------|
| Set | AT+CMMS=[<mode>] | OK | AT+CMMS=2 OK |
| Read | AT+CMMS? | +CMMS: <mode> OK | +CMMS: 2 OK |
| Test | AT+CMMS=? | +CMMS: (list of supported <mode>s) OK | +CMMS: (0-2) OK |

| Type | Syntax | Response | Example |
|------|--------|----------|---------|
| | | OK | |

9.23.3 Defined values

| Parameter | Type | Description |
|-----------|--------|---|
| <mode> | Number | Allowed values: <ul style="list-style-type: none"> 0 (default value): disabled 1: keep enabled until the time between the response of the latest message send command (such as +CMGS) and the next send command exceeds 5 s, then close the link and switch <mode> automatically back to 0 2: keep permanently enabled. The link is closed after each send sequence, but <mode> is not switched back to 0 |

9.24 Peek message +UCMGP

| +UCMGP | | | | | | |
|------------|-----------------------------------|--------------|----------------|----------------|---------------|-----------------|
| Modules | SARA-R422 SARA-R422M8S SARA-R422S | | | | | |
| Attributes | Syntax | PIN required | Settings saved | Can be aborted | Response time | Error reference |
| | full | Yes | No | No | <10 s | +CMS Error |

9.24.1 Description

Returns the message with location value <index> from message storage <mem1> to the DTE, the same as **+CMGR** does.

The SMS message is only 'peeked', i.e. its status is not forced to "received read SMS mode" after reading.

The syntax, defined values and remarks are the same as described for **+CMGR**.

 The PIN verification is not required when the preferred memory storage is "ME".

9.24.2 Syntax

| Type | Syntax | Response | Example |
|------|---|---|--|
| Set | Text mode (+CMGF=1): AT+UCMGP=<index> | (SMS-DELIVER) +UCMGP: <stat>,<oa>,[<alpha>], <scts>[,<tooa>,<fo>,<pid>,<dcs>], <sca>,<tosca>,<length> <data> OK | AT+UCMGP=303 +UCMGP: "REC UNREAD", "+393488535999",,"07/04/05,18:0 2:28+08",145,4,0,0,"+393492000 466",145,93 You have a missed called. Free information provided by your operator. |
| | | (SMS-SUBMIT) +UCMGP: <stat>,<da>,[<alpha>],[<toda>,<fo>,<pid>,<dcs>],[<vp>], <sca>,<tosca>,<length> <data> OK | OK |
| | | (SMS-STATUS-report) +UCMGP: <stat>,<fo>,<mr>,[<ra>], [<tora>],<scts>,<dt>,<st> OK | |
| | | (SMS-COMMAND) +UCMGP: <stat>,<fo>,<ct>[,<pid>], [<mn>],[<da>],[<toda>],<length> [<cdata>]] OK | |
| | | (CBM storage) +UCMGP: <stat>,<sn>,<mid>, <dcs>,<page>,<pages> | |

| Type | Syntax | Response | Example |
|------|--|--|---|
| | | <data> | |
| | | OK | |
| | PDU mode (+CMGF=0): AT+UCMGP=<index> | +UCMGP: <stat>,[<alpha>], <length> <pdu> OK | AT+UCMGP=1 +UCMGP: 0,,40 0791934329002000040C9193230 982 6614000080703280452180 18D4F29CF E06B5CBF379F87C4EBF41E4340 82E7F DBC3 OK |
| Test | AT+UCMGP=? | OK | |

9.24.3 Defined values

| Parameter | Type | Description |
|-----------|--------|------------------|
| <index> | Number | Storage position |

9.24.4 Notes

SARA-R4 / SARA-N4

- The <stat> parameter is blank in **SMS-STATUS-report** displaying case.

9.25 Send SMS command +CMGC

| +CMGC | | | | | | |
|------------|-----------------------------------|--------------|----------------|----------------|--|-----------------|
| Modules | SARA-R422 SARA-R422M8S SARA-R422S | | | | | |
| Attributes | Syntax | PIN required | Settings saved | Can be aborted | Response time | Error reference |
| | full | Yes | No | No | Up to 3 min (<1 s for prompt ">" when present) | +CMS Error |

9.25.1 Description

Sends a command message from a DTE to the network (SMS-SUBMIT). The message reference value <mr> is returned to the DTE for a successful message delivery. Optionally (when enabled by **+CSMS** AT command and network supports) the <ackpdu> parameter is returned. Values can be used to identify message upon unsolicited delivery status report result code. <Ctrl-Z> indicates that the SMS shall be sent, while <ESC> indicates aborting of the edited SMS.

The entered PDU is preceded by a ">" (Greater-Than sign) character, and this indicates that the interface is in "PDU enter" mode. The DCD signal shall be in ON state while the PDU is entered.

The +CMT URC is issued on the reception of the SMS messages.

9.25.2 Syntax

| Type | Syntax | Response | Example |
|------|--|------------------------------|---|
| Set | Text mode (+CMGF=1): AT+CMGC=<fo>,<ct>[,<pid>[,<mn>[,<da>[,<toda>]]]]<CR> > text is entered<Ctrl-Z/ESC> | +CMGC: <mr>[,<scts>] OK | AT+CMGC=17,0<CR> > This is the text<Ctrl-Z> +CMGC: 20 OK |
| | PDU mode (+CMGF=0): AT+CMGC=<length><CR> > <PDU> is given<Ctrl-Z/ESC> | +CMGC: <mr>[,<ackpdu>] OK | AT+CMGC=13<CR> > 039121430100038166F60000 4E374F80D<Ctrl-Z> +CMGC: 2 |

| Type | Syntax | Response | Example |
|------|-----------|---|---------|
| Test | AT+CMGC=? | OK | OK |
| URC | | +CMT: [<alpha>], <length><CR><LF><pdu> | |

9.25.3 Defined values

| Parameter | Type | Description |
|-----------|--------|---|
| <mr> | Number | Message reference |
| <length> | Number | PDU's length in octets without the Service Center's address. In example 039121430100038166F6000004E374F80D: is a PDU with Service Center's number +1234, that generates the address 03912143 (4 octets). Thus in this case <length>=13. |
| <PDU> | String | Protocol Data Unit: each 8-bit octet of the PDU must be written as two IRA character long hexadecimal numbers, e.g. octet with integer value 42 must be written as two characters 2A (IRA 50 and 65). |
| <ackpdu> | String | See the 3GPP TS 23.040 [63] RP-User-Data element of RP-ACK PDU; format is same as for <PDU> in case of SMS. |
| <alpha> | String | Alphanumeric representation of destination or originating address. See the 3GPP TS 27.005 [69]. |
| <fo> | Number | First octet of the SMS TPDU (see 3GPP TS 23.040 [63]) |
| <ct> | Number | TP-Command-Type (default value: 0) |
| <pid> | Number | TP-Protocol-Identifier (default value: 0); see the 3GPP TS 23.040 [63] |
| <mn> | Number | See the 3GPP TS 23.040 [63] TP-Message-Number in integer format |
| <da> | String | Destination address |
| <toda> | Number | Type of address of <da> - octet |

9.26 Sending of originating data via the control plane +CSODCP

| +CSODCP | | | | | | |
|-------------------|--|---------------------|-----------------------|-----------------------|----------------------|------------------------|
| Modules | SARA-R410M-02B SARA-R410M-63B SARA-R410M-73B SARA-R410M-83B SARA-R412M SARA-R422 SARA-R422M8S SARA-R422S SARA-N4 | | | | | |
| Attributes | Syntax | PIN required | Settings saved | Can be aborted | Response time | Error reference |
| | full | No | No | No | - | +CME Error |

9.26.1 Description

Transmits data over control plane from a DTE to the network. Data is identified by the local context identification parameter <cid>. This command causes transmission of an ESM DATA TRANSPORT message (see the 3GPP TS 24.301 [102] subclause 9.9.4.25).

It optionally indicates that the exchange of data will be completed with:

- Current uplink data transfer
- The next received downlink data



SARA-R410M / SARA-R412M

The command works only in case the Mobile Network Operator (MNO) profile in use has EPS-only service domain set. Otherwise, the service domain can be configured by means of the +USVCDOMAIN AT command.

9.26.2 Syntax

| Type | Syntax | Response | Example |
|------|--|--|---|
| Set | AT+CSODCP=<cid>,<cpdata_length>,<cpdata>[,<RAI>[,<type_of_user_data>]] | OK | AT+CSODCP=1,3,"AA11BB" OK |
| Test | AT+CSODCP=? | +CSODCP: (range of supported <cid>s),(maximum number of bytes of the <cpdata_length>),(list of | +CSODCP: (0-10),(512),(0-2),(0,1) OK |

| Type | Syntax | Response | Example |
|------|--------|--|---------|
| | | supported <RAI>s),(list of supported <type_of_user_data>s) | |
| | | OK | |

9.26.3 Defined values

| Parameter | Type | Description |
|---------------------|--------|--|
| <cid> | Number | See <cid> |
| <cpdata_length> | Number | Size of the received data. The maximum length is 512 bytes |
| <cpdata> | String | User data container content (see the 3GPP TS 24.301 [102] subclause 9.9.4.24) |
| <RAI> | Number | Indicates the value of the release assistance indication (see the 3GPP TS 24.301 [102] subclause 9.9.4.25). Allowed values: <ul style="list-style-type: none"> 0 (default value): no information available 1: data exchange completed with the transmission of the ESM DATA TRANSPORT message. 2: data exchange completed with the receipt of the ESM DATA TRANSPORT message. |
| <type_of_user_data> | Number | Indicates the type of user data: <ul style="list-style-type: none"> 0 (default value): regular data 1: exception data |

9.26.4 Notes

SARA-R410M-02B / SARA-R412M

- The <RAI> parameter (release assistance) is not supported.
- The command is not supported by SARA-R410M-02B-00.

9.27 Terminating data reporting via control plane +CRTDCP

| +CRTDCP | | | | | | |
|-------------------|--|---------------------|-----------------------|-----------------------|----------------------|------------------------|
| Modules | SARA-R410M-02B SARA-R410M-63B SARA-R410M-73B SARA-R410M-83B SARA-R412M SARA-R422 SARA-R422M8S SARA-R422S SARA-N4 | | | | | |
| Attributes | Syntax | PIN required | Settings saved | Can be aborted | Response time | Error reference |
| | full | No | No | No | - | +CME Error |

9.27.1 Description

Configures the terminating data reporting from network to the DTE via the control plane. Data is identified by the local context identification parameter <cid>. When enabled, the URC is sent from the MT upon reception of data from network.

9.27.2 Syntax

| Type | Syntax | Response | Example |
|------|-----------------------|--|-----------------------------------|
| Set | AT+CRTDCP=<reporting> | OK | AT+CRTDCP=1 OK |
| Read | AT+CRTDCP? | +CRTDCP: <reporting> OK | +CRTDCP: 1 OK |
| Test | AT+CRTDCP=? | +CRTDCP: (list of supported <reporting>s),(range of supported <cid>s),(maximum number of octets of user data indicated by <cpdata_length>) OK | +CRTDCP: (0-1),(0-10),(512) OK |
| URC | | +CRTDCP: <cid>,<cpdata_length>,<cpdata> OK | +CRTDCP: 0,1,"ab" |

9.27.3 Defined values

| Parameter | Type | Description |
|-----------------|--------|--|
| <reporting> | Number | Allowed values: <ul style="list-style-type: none">• 0 (default value): reporting disabled• 1: reporting enabled by means of the URC +CRTDCP |
| <cid> | Number | See <cid> |
| <cpdata_length> | Number | Size of the received data. The maximum length 512 bytes |
| <cpdata> | String | User data container content (see the 3GPP TS 24.301 [102] subclause 9.9.4.24) |

9.27.4 Notes

SARA-R410M-02B

- The command is not supported by SARA-R410M-02B-00.

10 V24 control and V25ter

10.1 Introduction

These commands, unless specifically stated, do not implement set syntax using "=", read ("?"), or test ("=?"). If such commands are used, the "+CME ERROR: unknown" or "+CME ERROR: 100" error result code is provided (depending on the [+CMEE](#) AT command setting).

10.2 Circuit 109 behavior &C

| &C | | | | | | |
|-------------------|---------------|---------------------|-------------------------|-----------------------|----------------------|----------------------------|
| Modules | All products | | | | | |
| Attributes | Syntax | PIN required | Settings saved | Can be aborted | Response time | Error reference |
| | full | No | Profile | No | - | +CME Error |

10.2.1 Description

Controls how the state of RS232 circuit 109 - Data Carrier Detect (DCD) - relates to the detection of received line signal from the remote end.

10.2.2 Syntax

| Type | Syntax | Response | Example |
|--------|---------------|----------|---------|
| Action | AT&C[<value>] | OK | |

10.2.3 Defined values

| Parameter | Type | Description |
|-----------|--------|--|
| <value> | Number | Indicates the behavior of circuit 109 <ul style="list-style-type: none"> 0: DCE always presents ON condition on circuit 109 1 (default value and factory-programmed value): circuit 109 changes in accordance with the Carrier detect status; ON if the Carrier is detected, OFF otherwise |

10.2.4 Notes

- See the corresponding module system integration manual for the DCD behavior during the initialization phase of the module.

SARA-R4 / SARA-N4

- The command setting is not stored in the personal profile.

10.3 Circuit 108/2 and escape sequence behavior &D

| &D | | | | | | |
|-------------------|---------------|---------------------|-------------------------|-----------------------|----------------------|----------------------------|
| Modules | All products | | | | | |
| Attributes | Syntax | PIN required | Settings saved | Can be aborted | Response time | Error reference |
| | full | No | Profile | No | - | +CME Error |

10.3.1 Description

Controls how the state of RS232 circuit 108/2 - Data Terminal Ready (DTR) - relates to changes from ON-to-OFF transition during on-line data state.

It also controls how the escape sequence may change the on-line data state.

10.3.2 Syntax

| Type | Syntax | Response | Example |
|--------|---------------|----------|---------|
| Action | AT&D[<value>] | OK | |

10.3.3 Defined values

| Parameter | Type | Description |
|-----------|--------|--|
| <value> | Number | Allowed values: <ul style="list-style-type: none"> 0: the DCE ignores circuit 108/2 1 (default value and factory-programmed value) or 2: upon an ON-to-OFF transition of circuit 108/2, the DCE performs an orderly clear-down of the call. The automatic answer is disabled while circuit 108/2 remains OFF |

10.3.4 +++ behavior

- A special meaning of the &D value is provided for the +++ sequence during a PSD data transfer with PPP L2 protocol (this is outside the ITU-T V.25ter recommendation [185] scope). With the AT&D1 and AT&D2 values the PSD data transfer is escaped and the system returns in the on-line command state. The [ATO](#) command is used to resume the PSD data transfer session.
- With the &D0 values the +++ sequence is ignored.



For the DTR behavior during the initialization phase of the module, see the SARA-R4 series system integration manual [15].

10.3.5 DTR, +++ behavior

| PSD data mode (PPP L2 protocol case) | | |
|--------------------------------------|--------------------------------|--------------------------|
| Event | DTE sends +++ | DTR ON-to-OFF transition |
| &D0 | No action | No action |
| &D1 | DCE enters online command mode | Context deactivation |
| &D2 | DCE enters online command mode | Context deactivation |

Table 8: PSD data mode

| Direct Link mode | | |
|------------------|--------------------------------------|--------------------------|
| Event | DTE sends escape sequence (e.g. +++) | DTR ON-to-OFF transition |
| &D0 | DCE enters command mode | No action |
| &D1 | DCE enters command mode | DCE enters command mode |
| &D2 | DCE enters command mode | DCE enters command mode |

Table 9: Direct Link mode

10.3.6 Notes

- The escape sequence for the PSD data mode with a L2 protocol different from the PPP is not ~+++, and it could be not supported. For more information, see the [S2 notes](#).

SARA-R4 / SARA-N4

- The command setting is not stored in the personal profile.

SARA-R422 / SARA-R422M8S / SARA-R422S

- On the AUX UART interface, the DTR line is always considered to ON state (even if the AUX UART interface does not support the DTR line).
- Setting a 5-wire UART configuration (for mode details, see the [+USIO](#) AT command), on the UART interface the DTR line is always considered to ON state (even if the UART interface does not support the DTR line).

10.4 DSR override &S

&S

| | | | | | | |
|-------------------|---------------|---------------------|-------------------------|-----------------------|----------------------|----------------------------|
| Modules | All products | | | | | |
| Attributes | Syntax | PIN required | Settings saved | Can be aborted | Response time | Error reference |
| | full | No | Profile | No | - | +CME Error |

10.4.1 Description

Selects how the module will control RS232 circuit 107 - Data Set Ready (DSR).

10.4.2 Syntax

| Type | Syntax | Response | Example |
|--------|---------------|----------|---------|
| Action | AT&S[<value>] | OK | |

10.4.3 Defined values

| Parameter | Type | Description |
|-----------|--------|---|
| <value> | Number | <ul style="list-style-type: none"> 0: sets the DSR line to ON 1 (default value and factory-programmed value): sets the DSR line to ON in data mode and to OFF in command mode |

10.4.4 Notes

- See the corresponding module system integration manual for the DSR behavior during the initialization phase of the module.

SARA-R4 / SARA-N4

- The command setting is not stored in the personal profile.

10.5 Flow control &K

&K

| | | | | | | |
|-------------------|--|---------------------|-------------------------|-----------------------|----------------------|----------------------------|
| Modules | SARA-R410M-02B SARA-R410M-52B SARA-R410M-63B SARA-R410M-73B SARA-R410M-83B SARA-R412M SARA-R422 SARA-R422M8S SARA-R422S | | | | | |
| Attributes | Syntax | PIN required | Settings saved | Can be aborted | Response time | Error reference |
| | full | No | Profile | No | - | +CME Error |

10.5.1 Description

Controls the flow control mechanism. The following settings are allowed:

- No flow control
- HW flow control also referred with RTS / CTS flow control
- SW flow control also referred with XON / XOFF flow control

10.5.2 Syntax

| Type | Syntax | Response | Example |
|--------|---------------|----------|---------|
| Action | AT&K[<value>] | OK | |

10.5.3 Defined values

| Parameter | Type | Description |
|-----------|--------|---|
| <value> | Number | <ul style="list-style-type: none"> 0: disable DTE flow control 3 (default and factory-programmed value): enable the RTS/CTS DTE flow control 4: enable the XON/XOFF DTE flow control 5: enable the XON/XOFF DTE flow control 6: enable the XON/XOFF DTE flow control |

10.5.4 Notes

- The command handling is the same for <value> parameter 4, 5 or 6.

SARA-R4

- The command setting is not stored in the personal profile.
- The SW flow control is not supported (<value>=4, 5 and 6 are not allowed).

SARA-R410M-02B

- The command is not supported by SARA-R410M-02B-00.

10.6 DTE-DCE character framing +ICF

| +ICF | | | | | | |
|-------------------|---------------|---------------------|-------------------------|-----------------------|----------------------|----------------------------|
| Modules | All products | | | | | |
| Attributes | Syntax | PIN required | Settings saved | Can be aborted | Response time | Error reference |
| | partial | Yes | Profile | No | - | +CME Error |

10.6.1 Description

Sets the local serial port start-stop (asynchronous) character framing which is used in information interchange between DCE and DTE. Value 0 corresponds to the auto-detect case (if autobauding is supported).



The following restrictions must be reminded:

- If a data frame format refers to a frame without parity (ex. Format 3), the command is accepted, but the parity value is ignored; it is returned by the AT+ICF read command (and displayed by [AT&V](#)) but it has no meaning
- The command setting is ignored when the AT command interface runs on the USB or on the SPI interface

10.6.2 Syntax

| Type | Syntax | Response | Example |
|------|------------------------------|---|---------------------------|
| Set | AT+ICF=[<format>[,<parity>]] | OK | AT+ICF=3,1 OK |
| Read | AT+ICF? | +ICF: <format>,<parity> OK | +ICF: 3,1 OK |
| Test | AT+ICF=? | +ICF: (list of supported <format>s), (list of supported <parity>s) OK | +ICF: (0-3,5),(0-1) OK |

10.6.3 Defined values

| Parameter | Type | Description |
|-----------|--------|--|
| <format> | Number | <ul style="list-style-type: none"> 0: auto detect 1: 8 data 2 stop 2: 8 data 1 parity 1 stop 3: 8 data 1 stop 4: 7 data 2 stops 5: 7 bit, 1 parity, 1 stop 6: 7 bit, 1 stop |
| <parity> | Number | <ul style="list-style-type: none"> 0: odd 1: even |

10.6.4 Notes

SARA-R4 / SARA-N4

- The command setting is not stored in the personal profile.
- Automatic frame recognition is not supported (<format> cannot be set to 0).
- The only supported values are <format> = 3 and <parity> = 1.

10.7 DTE-DCE local flow control +IFC

| +IFC | | | | | | |
|-------------------|---|---------------------|-------------------------|-----------------------|----------------------|----------------------------|
| Modules | SARA-R410M-02B SARA-R410M-52B SARA-R410M-63B SARA-R410M-73B SARA-R410M-83B SARA-R412M SARA-R422 SARA-R422M8S SARA-R422S SARA-N4 | | | | | |
| Attributes | Syntax | PIN required | Settings saved | Can be aborted | Response time | Error reference |
| | full | No | Profile | No | - | +CME Error |

10.7.1 Description

Controls the operation of the local flow control between DTE and DCE used when the data are sent or received.

When the software flow control (XON/XOFF) is used, the DC1 (XON, 0x11) and DC3 (XOFF, 0x13) characters are reserved and therefore filtered (e.g. in SMS text mode these two characters can not be input).

Since the DTE-DCE communication relies on the correct reception of DC1/DC3 characters, the UART power saving should be disabled on the module when SW flow control is used. If the UART power saving is active, the DC1/DC3 characters could be used to wake up the module's UART, and therefore lost. In case a DC3 character (XOFF) is correctly received by module's UART and some data is waiting to be transmitted, the module is forced to stay awake until a subsequent DC1 character (XON) is received.



The software flow control (XON/XOFF) setting is not allowed on the USB interfaces, on the SPI interface and on a multiplexer channel. See the [Multiple AT command interfaces](#) for all the behavior differences in respect to the supported interfaces.

10.7.2 Syntax

| Type | Syntax | Response | Example |
|------|--------------------------------------|--|-------------------------|
| Set | AT+IFC=[<DCE_by_DTE>[,<DTE_by_DCE>]] | +IFC: <DCE_by_DTE>,<DTE_by_DCE> OK | AT+IFC=2,2 OK |
| Read | AT+IFC? | +IFC: <DCE_by_DTE>,<DTE_by_DCE> OK | +IFC: 2,2 OK |
| Test | AT+IFC=? | +IFC: (list of supported <DCE_by_DTE>),(list of supported <DTE_by_DCE>s) OK | +IFC: (0-2),(0-2) OK |

10.7.3 Defined values

| Parameter | Type | Description |
|--------------|--------|--|
| <DCE_by_DTE> | Number | <ul style="list-style-type: none"> 0: none 1: DC1/DC3 on circuit 103 (XON/XOFF) 2 (default and the factory-programmed value): circuit 105 (RTS) |
| <DTE_by_DCE> | Number | <ul style="list-style-type: none"> 0: none 1: DC1/DC3 on circuit 104 (XON/XOFF) 2 (default and the factory-programmed value): circuit 106 (CTS) |

10.7.4 Notes

- <DCE_by_DTE> and <DTE_by_DCE> parameters must be provided with the same value in pairs (only (0, 0), (1,1) and (2,2) are allowed. The other combinations are not allowed and the "+CME ERROR: operation not allowed" error result code is returned).

SARA-R4 / SARA-N4

- The command has no effect.

10.8 Set flow control \Q

\Q

| | | | | | | |
|-------------------|---------------|---------------------|-----------------------|-----------------------|----------------------|------------------------|
| Modules | All products | | | | | |
| Attributes | Syntax | PIN required | Settings saved | Can be aborted | Response time | Error reference |
| | full | No | No | No | - | +CME Error |

10.8.1 Description

Controls the operation of the local flow control between DTE and DCE. It is used when the data are sent or received.

When the software flow control (XON/XOFF) is used, the DC1 (XON, 0x11) and DC3 (XOFF, 0x13) characters are reserved and therefore filtered (e.g. in SMS text mode these two characters can not be input).

Since the DTE-DCE communication relies on the correct reception of DC1/DC3 characters, the UART power saving should be disabled on the module when SW flow control is used. If the UART power saving is active, the DC1/DC3 characters could be used to wake up the module's UART, and therefore lost. In case a DC3 character (XOFF) is correctly received by module's UART and some data is waiting to be transmitted, the module is forced to stay awake until a subsequent DC1 character (XON) is received.



The software flow control (XON/XOFF) setting is not allowed on the USB interfaces, on the SPI interface and on a multiplexer channel. See the [Multiple AT command interfaces](#) for all the behavior differences in respect to the supported interfaces.

10.8.2 Syntax

| Type | Syntax | Response | Example |
|------|---------------|----------|-------------|
| Set | AT\Q[<value>] | OK | AT\Q3 OK |

10.8.3 Defined values

| Parameter | Type | Description |
|-----------|--------|--|
| <value> | Number | <ul style="list-style-type: none"> 0: no flow control 1: DC1/DC3 on circuit 103 and 104 (XON/XOFF) 3 (default value): DCE_by_DTE on circuit 105 (RTS) and DTE_by_DCE on circuit 106 (CTS) |

10.8.4 Notes

SARA-R4 / SARA-N4

- <value>=0 (no flow control) and 1 (SW flow control) are not supported.

10.9 UART data rate configuration +IPR

+IPR

| | | | | | | |
|-------------------|---------------|---------------------|-----------------------|-----------------------|----------------------|------------------------|
| Modules | All products | | | | | |
| Attributes | Syntax | PIN required | Settings saved | Can be aborted | Response time | Error reference |
| | partial | No | Profile | No | - | +CME Error |

10.9.1 Description

Specifies the data rate at which the DCE accepts commands on the UART interface. The full range of data rates depends on HW or other criteria.



SARA-R4 / SARA-N4

The command is not applicable on the USB interface and the DCE returns an error result code if the command is issued.

10.9.2 Syntax

| Type | Syntax | Response | Example |
|------|-----------------|---|---|
| Set | AT+IPR=[<rate>] | OK | AT+IPR=9600 OK |
| Read | AT+IPR? | +IPR: <rate> OK | +IPR: 9600 OK |
| Test | AT+IPR=? | +IPR: (list of supported autodetectable <rate> values)[,(list of fixed only <rate> values)] OK | +IPR: (0,2400,4800,9600,19200,38400,57600,115200),() OK |

10.9.3 Defined values

| Parameter | Type | Description |
|-----------|--------|---|
| <rate> | Number | Allowed baud rates expressed in b/s (0, if present, means autobauding): <ul style="list-style-type: none"> SARA-R404M/SARA-R410M-01B - 9600, 19200, 38400, 57600, 115200 (default and factory-programmed value) SARA-R410M-02B / SARA-R410M-52B / SARA-R410M-63B / SARA-R410M-73B / SARA-R410M-83B/SARA-R412M/SARA-N4 - The information text response to the test command returns a list of baud rates; within this list the only supported baud rates are: 9600, 19200, 38400, 57600, 115200 (default and factory-programmed value), 230400, 460800. SARA-R422 / SARA-R422M8S / SARA-R422S - 9600, 19200, 38400, 57600, 115200 (default and factory-programmed value), 230400, 460800 |
| | | SARA-R410M-02B On SARA-R410M-02B-00 the information text response to the test command returns a list of baud rates; within this list the only supported baud rates are: 9600, 19200, 38400, 57600, 115200 (default and factory-programmed value). |

10.9.4 Notes

- On the UART AT interface, after the reception of the "OK" result code for the +IPR command, the DTE shall wait for at least 100 ms before issuing a new AT command; this is to guarantee a proper baud rate reconfiguration.

SARA-R4 / SARA-N4

- The command setting is stored in the NVM.
- This command is not supported in the multiplexer mode. See the [+CMUX](#) AT command for more details.
- The <rate> parameter is mandatory.
- Baud rate changes using +IPR may occur asynchronously to the final result code.

10.10 Return to on-line data state O

O

| Modules | All products | | | | | |
|------------|--------------|--------------|----------------|----------------|---------------|----------------------------|
| Attributes | Syntax | PIN required | Settings saved | Can be aborted | Response time | Error reference |
| | full | Yes | No | No | - | +CME Error |

10.10.1 Description

Causes the DCE to return to online data state and issue a CONNECT intermediate result code on DTE.

ATO command is used to resume both circuit-switched and packet-switched data call. The resume is only possible if the PPP L2 protocol is used.



SARA-R4 / SARA-N4

It allows the DCE to return to online data state, after an ON-to-OFF transition of circuit 108/2 has caused the DCE to enter in command mode (see [&D](#)).



SARA-R4 / SARA-N4

Depending on [ATX](#) command setting the CONNECT IRC can be properly configured in order to provide also the data rate (CONNECT <text>).

10.10.2 Syntax

| Type | Syntax | Response | Example |
|--------|--------|------------|----------------|
| Action | ATO | <response> | ATO CONNECT |

10.10.3 Defined values

| Parameter | Type | Description |
|------------|--------|--|
| <response> | String | <ul style="list-style-type: none"> CONNECT NO CARRIER: the online data state cannot be resumed |

10.10.4 Notes

- The command provides an error result code ("CME ERROR: operation not allowed" if [+CME](#) is set to 2) in the following cases:
 - The DCE is not in online command state
 - It is issued on a DCE different from the one in online command state
- In case of PSD call, any data from the network (downlink data) received by the DCE during the on-line command state is discarded. This means that after the O command and on-line data state resume, any possible data loss has to be recovered by upper layer protocols (e.g. TCP).

10.11 Escape character S2

| S2 | | | | | | |
|------------|--------------|--------------|-------------------------|----------------|---------------|----------------------------|
| Modules | All products | | | | | |
| Attributes | Syntax | PIN required | Settings saved | Can be aborted | Response time | Error reference |
| | partial | No | Profile | No | - | +CME Error |

10.11.1 Description

Controls the decimal value of the ASCII character used as the escape character. A value greater than 127 disables the escape process, i.e. no escape character will be recognized. The escape sequence contains three escape characters e.g. "+++".

10.11.2 Syntax

| Type | Syntax | Response | Example |
|------|--------------|---------------|---------------|
| Set | ATS2=<value> | OK | ATS2=43 OK |
| Read | ATS2? | <value> OK | 043 OK |

10.11.3 Defined values

| Parameter | Type | Description |
|-----------|--------|--|
| <value> | Number | Range 1 to 255. The answer to the read command is in "xxx" format. The default and the factory-programmed value is 43 (ASCII '+'). |

10.11.4 Notes

SARA-R4 / SARA-N4

- The command has no effect.

10.12 Command line termination character S3

S3

| | | | | | | |
|-------------------|---------------|---------------------|-------------------------|-----------------------|----------------------|----------------------------|
| Modules | All products | | | | | |
| Attributes | Syntax | PIN required | Settings saved | Can be aborted | Response time | Error reference |
| | partial | Yes | Profile | No | - | +CME Error |

10.12.1 Description

Sets a value representing the decimal IRA5 value of the character recognized by the DCE from the DTE, to terminate the incoming command line. It is also generated by the DCE as part of the header, trailer and terminator for result codes and information text, along with the S4 setting.

10.12.2 Syntax

| Type | Syntax | Response | Example |
|------|--------------|---------------|---------------|
| Set | ATS3=<value> | OK | ATS3=13 OK |
| Read | ATS3? | <value> OK | 013 OK |

10.12.3 Defined values

| Parameter | Type | Description |
|-----------|--------|--|
| <value> | Number | Range 0 to 127. The answer to the read command is in "xxx" format. The default and the factory-programmed value is 13 (ASCII carriage return (CR, IRA5 0/13)). |

10.12.4 Notes

SARA-R4 / SARA-N4

- The command setting is not stored in the personal profile.

10.13 Response formatting character S4

S4

| | | | | | | |
|-------------------|---------------|---------------------|-------------------------|-----------------------|----------------------|----------------------------|
| Modules | All products | | | | | |
| Attributes | Syntax | PIN required | Settings saved | Can be aborted | Response time | Error reference |
| | partial | Yes | Profile | No | - | +CME Error |

10.13.1 Description

Sets a value representing the decimal IRA5 value of the character generated by the DCE as part of the header, trailer and terminator for result codes and information text, along with the S3 setting.

10.13.2 Syntax

| Type | Syntax | Response | Example |
|------|--------------|---------------|---------------|
| Set | ATS4=<value> | OK | ATS4=10 OK |
| Read | ATS4? | <value> OK | 010 OK |

10.13.3 Defined values

| Parameter | Type | Description |
|-----------|--------|--|
| <value> | Number | Range 0 to 127. The answer to the read command is in "xxx" format. The default and the factory-programmed value is 10 (line feed (LF, IRA5 0/10)). |

10.13.4 Notes

SARA-R4 / SARA-N4

- The command setting is not stored in the personal profile.

10.14 Command line editing character S5

| S5 | | | | | | |
|-------------------|---------------|---------------------|-------------------------|-----------------------|----------------------|----------------------------|
| Modules | All products | | | | | |
| Attributes | Syntax | PIN required | Settings saved | Can be aborted | Response time | Error reference |
| | partial | Yes | Profile | No | - | +CME Error |

10.14.1 Description

Sets a value representing the decimal IRA5 character recognized by the DCE as a request to delete from the command line the immediately preceding character.

10.14.2 Syntax

| Type | Syntax | Response | Example |
|------|--------------|---------------|--------------|
| Set | ATS5=<value> | OK | ATS5=8 OK |
| Read | ATS5? | <value> OK | 008 OK |

10.14.3 Defined values

| Parameter | Type | Description |
|-----------|--------|--|
| <value> | Number | Range 0 to 127. The answer to the read command is in "xxx" format. The default and the factory-programmed value is 8 (ASCII backspace (BS, IRA5 0/8)). |

10.14.4 Notes

SARA-R4 / SARA-N4

- The command setting is not stored in the personal profile.

10.15 Pause before blind dialling S6

| S6 | | | | | | |
|-------------------|---------------|---------------------|-----------------------|-----------------------|----------------------|----------------------------|
| Modules | All products | | | | | |
| Attributes | Syntax | PIN required | Settings saved | Can be aborted | Response time | Error reference |
| | partial | No | No | No | - | +CME Error |

10.15.1 Description

Specifies the time in seconds that the DCE waits between connecting to the line and dialling, when the dial tone is not implemented or enabled. The command is not applicable for signal based mobile phone software.

10.15.2 Syntax

| Type | Syntax | Response | Example |
|------|--------------|---------------|--------------|
| Set | ATS6=<value> | OK | ATS6=2 OK |
| Read | ATS6? | <value> OK | 002 OK |

10.15.3 Defined values

| Parameter | Type | Description |
|-----------|--------|--|
| <value> | Number | Range 2 - 10. The answer to the read command is in "xxx" format. The default value is 2 s. |

10.15.4 Notes

SARA-R4 / SARA-N4

- The command has no effect.

10.16 Connection completion timeout S7

S7

| Modules | All products | | | | | |
|------------|--------------|--------------|-------------------------|----------------|---------------|----------------------------|
| Attributes | Syntax | PIN required | Settings saved | Can be aborted | Response time | Error reference |
| | partial | No | Profile | No | - | +CME Error |

10.16.1 Description

Specifies the time in seconds, that the DCE shall allow between either answering a call or completion of dialling and establishment of a connection with a remote site.

10.16.2 Syntax

| Type | Syntax | Response | Example |
|------|--------------|----------|---------|
| Set | ATS7=<value> | OK | ATS7=30 |
| Read | ATS7? | <value> | 060 |
| | | OK | OK |

10.16.3 Defined values

| Parameter | Type | Description |
|-----------|--------|--|
| <value> | Number | Range 1 - 255. The answer to the read command is in "xxx" format. <ul style="list-style-type: none"> SARA-R4 / SARA-N4 - The default value is 0 |

10.16.4 Notes

SARA-R4 / SARA-N4

- The command has no effect.

10.17 Command dial modifier time S8

S8

| Modules | All products | | | | | |
|------------|--------------|--------------|----------------|----------------|---------------|----------------------------|
| Attributes | Syntax | PIN required | Settings saved | Can be aborted | Response time | Error reference |
| | partial | No | No | No | - | +CME Error |

10.17.1 Description

Specifies the amount of time, in seconds, that the DCE shall pause during dialling, when a ',' (comma) dial modifier is encountered in a dial string.

-  The command has no effect.

10.17.2 Syntax

| Type | Syntax | Response | Example |
|------|--------------|----------|---------|
| Set | ATS8=<value> | OK | ATS8=4 |
| | | OK | OK |

| Type | Syntax | Response | Example |
|------|--------|---------------|-----------|
| Read | ATS8? | <value> OK | 002 OK |

10.17.3 Defined values

| Parameter | Type | Description |
|-----------|--------|---|
| <value> | Number | Range 0 - 255. The answer to the read command is in "xxx" format. The default value is 2. |

10.18 Automatic disconnect delay S10

S10

| Modules | All products | | | | | |
|------------|--------------|--------------|----------------|----------------|---------------|-----------------|
| Attributes | Syntax | PIN required | Settings saved | Can be aborted | Response time | Error reference |
| | partial | No | No | No | - | +CME Error |

10.18.1 Description

Specifies the time in tenth of a second, that the DCE will remain connected to the line after the DCE has indicated the absence of received line signal. Not supported for GSM but the OK response is returned.

10.18.2 Syntax

| Type | Syntax | Response | Example |
|------|---------------|---------------|----------------|
| Set | ATS10=<value> | OK | ATS10=30 OK |
| Read | ATS10? | <value> OK | 030 OK |

10.18.3 Defined values

| Parameter | Type | Description |
|-----------|--------|---------------------------|
| <value> | Number | Range 1 - 254. Default: 1 |

10.18.4 Notes

SARA-R4 / SARA-N4

- The command has no effect.

10.19 Escape prompt delay (EPD) S12

S12

| Modules | All products | | | | | |
|------------|--------------|--------------|----------------|----------------|---------------|-----------------|
| Attributes | Syntax | PIN required | Settings saved | Can be aborted | Response time | Error reference |
| | partial | No | No | No | - | +CME Error |

10.19.1 Description

Defines the maximum period, in fiftieths of a second, allowed between the reception of the last character of the sequence of three escape characters from the DTE and the sending of the OK result code to the DTE. If any characters are detected during this time, the OK will not be sent.

Furthermore, the timeout is:

- The minimum period, before the first character reception of the three escape character sequence, during which no other character must be detected to accept it as a valid first character
- The maximum period allowed between receipt of first, or second, character of the three escape character sequence and receipt of the next
- The minimum period, after the last character reception of the three escape character sequence, during which no other character must be detected to accept the escape sequence as a valid one

10.19.2 Syntax

| Type | Syntax | Response | Example |
|------|---------------|---------------|----------------|
| Set | ATS12=<value> | OK | ATS12=80 OK |
| Read | ATS12? | <value> OK | 050 OK |

10.19.3 Defined values

| Parameter | Type | Description |
|-----------|--------|---|
| <value> | Number | Range 0 - 255. The answer to the read command is in "xxx" format. The default value is 50 (1 s) |

10.19.4 Notes

SARA-R4 / SARA-N4

- The command has no effect.

10.20 Command echo E

| E | | | | | | |
|------------|--------------|--------------|-------------------------|----------------|---------------|----------------------------|
| Modules | All products | | | | | |
| Attributes | Syntax | PIN required | Settings saved | Can be aborted | Response time | Error reference |
| | full | No | Profile | No | - | +CME Error |

10.20.1 Description

Controls whether or not the MT echoes characters received from the DTE during command state.

10.20.2 Syntax

| Type | Syntax | Response | Example |
|------|--------------|----------|------------|
| Set | ATE[<value>] | OK | ATE1 OK |

10.20.3 Defined values

| Parameter | Type | Description |
|-----------|--------|--|
| <value> | Number | <ul style="list-style-type: none"> 0: echo off 1 (default and the factory-programmed value): echo on |

10.20.4 Notes

SARA-R4 / SARA-N4

- The command setting is stored in the NVM.

10.21 Result code suppression Q

| Q | | | | | | |
|------------|--------------|--------------|-------------------------|----------------|---------------|----------------------------|
| Modules | All products | | | | | |
| Attributes | Syntax | PIN required | Settings saved | Can be aborted | Response time | Error reference |
| | full | No | Profile | No | - | +CME Error |

10.21.1 Description

Determines if DCE transmits result codes to the DTE or not. When result codes are being suppressed, no portion of any intermediate, final or URC is transmitted. Information text transmitted in response to commands is not affected by this setting.

10.21.2 Syntax

| Type | Syntax | Response | Example |
|------|--------------|----------|------------|
| Set | ATQ[<value>] | OK | ATQ1 OK |

10.21.3 Defined values

| Parameter | Type | Description |
|-----------|--------|--|
| <value> | Number | <ul style="list-style-type: none"> 0 (default and the factory-programmed value): DCE transmits result codes 1: Result codes are suppressed and not transmitted |

10.21.4 Notes

SARA-R4 / SARA-N4

- The command setting is not stored in the personal profile.

10.22 DCE response format V

| V | | | | | | |
|------------|--------------|--------------|-------------------------|----------------|---------------|----------------------------|
| Modules | All products | | | | | |
| Attributes | Syntax | PIN required | Settings saved | Can be aborted | Response time | Error reference |
| | full | No | Profile | No | - | +CME Error |

10.22.1 Description

Control the contents of the header and trailer transmitted with result codes and information text responses. It also determines whether the result code is transmitted in a numeric form or an alphabetic (or verbose) form. The information text response is not affected by this setting. See [Information text responses and result codes](#) for description of the result code formats.

10.22.2 Syntax

| Type | Syntax | Response | Example |
|------|--------------|----------|------------|
| Set | ATV[<value>] | OK | ATV1 OK |

10.22.3 Defined values

| Parameter | Type | Description |
|-----------|--------|---|
| <value> | Number | <ul style="list-style-type: none"> 0: DCE transmits limited headers, trailers and numeric text 1 (default and the factory-programmed value): DCE transmits full headers, trailers and verbose response text |

10.22.4 Notes

SARA-R4 / SARA-N4

- The command setting is not stored in the personal profile.

10.23 Result code selection and call progress monitoring control X

| X | | | | | | |
|------------|--------------|--------------|-------------------------|----------------|---------------|----------------------------|
| Modules | All products | | | | | |
| Attributes | Syntax | PIN required | Settings saved | Can be aborted | Response time | Error reference |
| | full | Yes | Profile | No | - | +CME Error |

10.23.1 Description

In a CS data call, determines how the DCE transmits to the DTE the CONNECT result code.

10.23.2 Syntax

| Type | Syntax | Response | Example |
|------|--------------|----------|------------|
| Set | ATX[<value>] | OK | ATX1 OK |

10.23.3 Defined values

| Parameter | Type | Description |
|-----------|--------|--|
| <value> | Number | <ul style="list-style-type: none"> 0: CONNECT result code is given upon entering online data state; 1-4: CONNECT <speed> result code is given upon entering online data state; (4 is the default and the factory-programmed value) |
| <speed> | Number | Transfer speed for CSD calls configured via the CBST command |

10.23.4 Notes

SARA-R4 / SARA-N4

- The command setting is not stored in the personal profile.

10.24 Reset to default configuration Z

| Z | | | | | | |
|------------|--------------|--------------|----------------|----------------|---------------|----------------------------|
| Modules | All products | | | | | |
| Attributes | Syntax | PIN required | Settings saved | Can be aborted | Response time | Error reference |
| | full | No | No | No | - | +CME Error |

10.24.1 Description

Resets the DCE configuration into a known state; the reset includes the loading of the settings stored in the profile identified by the <value> parameter, into the current profile, and the application of the settings.

When the command is issued, any CSD call in progress is released. In case of success, the result code is issued using the format configuration (Q, V, S3, S4 commands) loaded from the requested profile. The other DCE settings are applied after the result code has been sent.

10.24.2 Syntax

| Type | Syntax | Response | Example |
|--------|--------------|----------|---------|
| Action | ATZ[<value>] | OK | |

10.24.3 Defined values

| Parameter | Type | Description |
|-----------|--------|--|
| <value> | Number | Profile index, optional parameter. Allowed values: <ul style="list-style-type: none"> SARA-R4 / SARA-N4 - 0 (default value) |

10.25 Set to factory defined configuration &F

| &F | | | | | | |
|------------|--------------|--------------|----------------|----------------|---------------|----------------------------|
| Modules | All products | | | | | |
| Attributes | Syntax | PIN required | Settings saved | Can be aborted | Response time | Error reference |
| | full | No | No | No | - | +CME Error |

10.25.1 Description

Resets the current profile to factory-programmed setting. Other NVM settings, not included in the profiles, are not affected.

In case of success, the response is issued using the configuration of the result codes format (Q, V, S3, S4 AT commands) loaded from the factory-programmed profile. The other DCE settings are applied after the response has been sent.

10.25.2 Syntax

| Type | Syntax | Response | Example |
|--------|---------------|----------|---------|
| Action | AT&F[<value>] | OK | |

10.25.3 Defined values

| Parameter | Type | Description |
|-----------|--------|----------------|
| <value> | Number | Only 0 allowed |

10.26 Display current configuration &V

| &V | | | | | | |
|-------------------|---|---------------------|-----------------------|-----------------------|----------------------|------------------------|
| Modules | SARA-R404M SARA-R410M SARA-R412M SARA-N4 | | | | | |
| Attributes | Syntax | PIN required | Settings saved | Can be aborted | Response time | Error reference |
| | full | No | No | No | - | +CME Error |

10.26.1 Description

Reports a summary of the current configuration and of the stored user profiles.



SARA-R4 / SARA-N4

For the complete list of the configuration items stored in the non volatile memory, see [Appendix B.2](#).

10.26.2 Syntax

| Type | Syntax | Response | Example |
|--------|--------|--|--|
| Action | AT&V | ACTIVE PROFILE: List of commands stored in the active profile with the related values STORED PROFILE 0: List of commands stored in the profile 0 with the related values STORED PROFILE 1: List of commands stored in the profile 1 with the related values OK | ACTIVE PROFILE: &C1, &D1, &S1, &K3, E1, Q0, V1, X4, S00:000, S02:043, S03:013, S04:010, S05:008, S07:060, +CBST:007, 000, 001, +CRLP:061, 061, 048, 006, +CR:000, +CRC:000, +IPR:0, +COPS:0,0, FFFFF, +ICF:3,1, +UPSV: 0, +CMGF:0, +CNMI:1,0,0,0,0, +USTS: 0 STORED PROFILE 0: &C1, &D1, &S1, &K3, E1, Q0, V1, X4, S00:000, S02:043, S03:013, S04:010, S05:008, S07:060, +CBST:007, 000, 001, +CRLP:061, 061, 048, 006, +CR:000, +CRC:000, +IPR:0, +COPS:0,0, FFFFF, +ICF:3,1, +UPSV: 0, +CMGF:0, +CNMI:1,0,0,0,0, +USTS: 0 STORED PROFILE 1: &C1, &D1, &S1, &K3, E1, Q0, V1, X4, S00:000, S02:043, S03:013, S04:010, S05:008, S07:060, +CBST:007, 000, 001, +CRLP:061, 061, 048, 006, +CR:000, +CRC:000, +IPR:0, +COPS:0,0, FFFFF, +ICF:3,1, +UPSV: 0, +CMGF:0, +CNMI:1,0,0,0,0, +USTS: 0 OK |

10.26.3 Notes

SARA-R404M / SARA-R410M / SARA-R412M / SARA-N4

- Only the ACTIVE PROFILE is displayed. The AT command does not show STORED PROFILE 0 or STORED PROFILE 1.
- Besides current active profile settings, all relevant settings, i.e. of volatile AT commands (e.g. +CEREG) as well as NVM stored settings (e.g. +CGDCONT) are displayed.

11 SIM management

11.1 Generic SIM access +CSIM

| +CSIM | | | | | | |
|-------------------|---|---------------------|-----------------------|-----------------------|----------------------|------------------------|
| Modules | SARA-R410M-02B SARA-R410M-52B SARA-R410M-63B SARA-R410M-73B SARA-R410M-83B SARA-R412M SARA-R422 SARA-R422M8S SARA-R422S SARA-N4 | | | | | |
| Attributes | Syntax | PIN required | Settings saved | Can be aborted | Response time | Error reference |
| | full | Yes | No | No | - | +CME Error |

11.1.1 Description

Allows direct control of the SIM by a distant application on the TE. This command transparently transmits the <command> to the SIM via the MT. The <response> is returned in the same manner to the TE.



The command needs the SIM module to work correctly.



It is recommended to wait some seconds after boot (or reset) before using the command.

11.1.2 Syntax

| Type | Syntax | Response | Example |
|------|----------------------------|----------------------------------|--|
| Set | AT+CSIM=<length>,<command> | +CSIM: <length>,<response> OK | AT+CSIM=14,"A0A40000027F20" +CSIM: 4,"6E00" OK |
| Test | AT+CSIM=? | OK | OK |

11.1.3 Defined values

| Parameter | Type | Description |
|------------|--------|--|
| <length> | Number | Length of the characters sent to the TE in <command> or <response> parameters |
| <command> | String | Command passed on by MT to SIM in hex format; see the 3GPP TS 51.011 [71] and ETSI TS 102 221 [150] |
| <response> | String | Response to the command passed on by the SIM to the MT (3GPP TS 51.011 [71] and ETSI TS 102 221 [150]) |

11.2 Restricted SIM access +CRSM

| +CRSM | | | | | | |
|-------------------|---------------|---------------------|-----------------------|-----------------------|----------------------|------------------------|
| Modules | All products | | | | | |
| Attributes | Syntax | PIN required | Settings saved | Can be aborted | Response time | Error reference |
| | full | Yes | No | No | < 10 s | +CME Error |

11.2.1 Description

Allows easy access to the SIM database. The set command transmits the SIM command and its required parameters to the MT. The MT handles internally all SIM-MT interface locking and file selection routines. As response to the command, the MT sends the actual SIM information parameters and response data. An error result code may be returned when the command cannot be passed to the SIM, but the failure in the execution of the command in the SIM is reported in <sw1> and <sw2> parameters.

The expected response time shall be increased when using a remote SIM card via SAP and in case of simultaneous access to the SIM by another AT interface or by internal clients (e.g. BIP, IMS).



The command needs the SIM module to work correctly.

11.2.2 Syntax

| Type | Syntax | Response | Example |
|------|--|---------------------------------------|--|
| Set | AT+CRSM=<command>[,<fileid>[,<P1>,<P2>,<P3>[,<data> [,<pathid>]]]] | +CRSM: <sw1>,<sw2>[,<response>] OK | AT+CRSM=176,28471,0,0,3 +CRSM: 144,0,"989301770020594178F2" OK |
| Test | AT+CRSM=? | OK | OK |

11.2.3 Defined values

| Parameter | Type | Description |
|------------------|--------|--|
| <command> | Number | Allowed values: <ul style="list-style-type: none"> • 176: read binary • 178: read record • 192: get response • 214: update binary • 220: update record • 242: status • 203: retrieve data • 219: set data |
| <fileid> | Number | Identifies an elementary datafile on SIM. Mandatory for each command except STATUS (e.g. 28423: meaning IMSI file (6F07)). For a complete description of Elementary Files (EF), see 3GPP TS 31.102 [72]. |
| <P1>, <P2>, <P3> | Number | Defines the request. These parameters are mandatory for each command, except GET RESPONSE and STATUS. The values are described in 3GPP TS 51.011 [71] and ETSI TS 102 221 [150]. |
| <data> | String | Information which shall be written to the SIM (hexadecimal character format; see the +CSCS - string containing hexadecimal characters) |
| <pathid> | String | Contains the path of an elementary file on the SIM/UICC in hexadecimal format as defined in ETSI TS 102 221 [150] (e.g. "7F205F70" in SIM and UICC case). The <pathid> shall only be used in the mode "select by path from MF" as defined in ETSI TS 102 221 [150]. |
| <sw1>, <sw2> | Number | Contains SIM information about the execution of the actual command and can be (more details in 3GPP TS 51.011 [71] and ETSI TS 102 221 [150]). Status words examples for 2G SIM cards: <ul style="list-style-type: none"> • 0x90 0x00: normal ending of the command • 0x9F 0xXX: length XX of the response data • 0x92 0x0X: command successful but after using an internal retry routine X times • 0x92 0x40: memory problem • 0x94 0x00: no EF selected • 0x94 0x02: out of range (invalid address) • 0x94 0x04: file ID not found; pattern not found • 0x94 0x08: file is inconsistent with the command • 0x98 0x02: no CHV initialized • 0x98 0x04: access condition not fulfilled / unsucc. CHV verify / authent.failed • 0x98 0x08: in contradiction with CHV status • 0x98 0x10: in contradiction with invalidation status • 0x98 0x40: unsucc. CHV-verif. or UNBLOCK CHV-verif. / CHV blocked / UNBL.blocked • 0x67 0xXX: incorrect parameter P3 • 0x6A 0x81: function not supported • 0x6A 0x82: file not found • 0x6B 0xXX: incorrect parameter P1 or P2 • 0x6D 0xXX: unknown instruction code given in the command • 0x6E 0xXX: wrong instruction class given in the command • 0x6F 0xXX: technical problem with no diagnostic given Status words examples for 3G SIM cards: <ul style="list-style-type: none"> • 0x90 0x00: normal ending of the command |

| Parameter | Type | Description |
|------------|--------|--|
| | | <ul style="list-style-type: none"> 0x91 0xXX: length XX of the response data 0x63 0xCX: command successful but after using an internal retry routine X times 0x62 0x00: no information given, state of non volatile memory unchanged 0x64 0x00: no information given, state of non-volatile memory unchanged 0x65 0x00: no information given, state of non-volatile memory changed 0x65 0x81: memory problem 0x67 0x00: wrong length 0x69 0x85: conditions of use not satisfied 0x69 0x86: command not allowed (no EF selected) 0x69 0x82: security status not satisfied 0x62 0x81: part of returned data may be corrupted 0x6A 0x81: function not supported 0x6A 0x82: file not found 0x6A 0x83: record not found 0x6B 0x00: wrong parameter(s) P1, P2 0x6D 0x00: instruction code not supported or invalid 0x6E 0x00: instruction code not supported or invalid 0x6F 0x00: technical problem, no precise diagnosis |
| <response> | String | The response of successful completion of the command previously issued (hexadecimal character format; see the +CSCS). STATUS and GET RESPONSE return data, which gives information about the current elementary datafield. This information includes the type of file and its size (see the 3GPP TS 51.011 [71] and the ETSI TS 102 221 [150]). After READ BINARY or READ RECORD command the requested data will be returned. <response> is not returned after a successful UPDATE BINARY or UPDATE RECORD command. |

11.2.4 Notes

SARA-R4 / SARA-N4

- <command>=203 and 219 are not supported.

11.3 Read the SIM language +CLAN

| +CLAN | | | | | | |
|-------------------|---|---------------------|-----------------------|-----------------------|----------------------|----------------------------|
| Modules | SARA-R410M-02B SARA-R410M-52B SARA-R410M-63B SARA-R410M-73B SARA-R410M-83B SARA-R412M SARA-R422 SARA-R422M8S SARA-R422S SARA-N4 | | | | | |
| Attributes | Syntax | PIN required | Settings saved | Can be aborted | Response time | Error reference |
| | full | No | No | No | - | +CME Error |

11.3.1 Description

Reads the language from the SIM.

The read syntax will display the most preferred language from the preferred language list in:

- SARA-R4 / SARA-N4 - EF_{ELP}(3F00/2F05). If the EF-ELP file does not exist, the preferred language is read from EF-LP (6F05) file.

11.3.2 Syntax

| Type | Syntax | Response | Example |
|------|----------------|---------------------|--------------------|
| Set | AT+CLAN=<code> | OK | AT+CLAN="en" OK |
| Read | AT+CLAN? | +CLAN: <code> OK | +CLAN: "en" OK |
| Test | AT+CLAN=? | OK | |

11.3.3 Defined values

| Parameter | Type | Description |
|-----------|--------|---|
| <code> | String | It is a two-letter abbreviation of the language. The language codes, as defined in ISO 639, consists of two characters, e.g. "en", "it" etc |

11.3.4 Notes

SARA-R4 / SARA-N4

- The set command is not supported.

11.4 Check for UICC card +UUICC

| +UUICC | | | | | | |
|------------|-----------------------------------|--------------|----------------|----------------|---------------|-----------------|
| Modules | SARA-R422 SARA-R422M8S SARA-R422S | | | | | |
| Attributes | Syntax | PIN required | Settings saved | Can be aborted | Response time | Error reference |
| | full | No | No | No | - | +CME Error |

11.4.1 Description

Returns the type of application which is present on the ICC or UICC.

11.4.2 Syntax

| Type | Syntax | Response | Example |
|------|-----------|-----------------------|-----------------|
| Read | AT+UUICC? | +UUICC: <state> OK | +UUICC: 1 OK |

11.4.3 Defined values

| Parameter | Type | Description |
|-----------|--------|---|
| <state> | Number | <ul style="list-style-type: none"> 0: 2G SIM (SIM application present) 1: 3G SIM (USIM application present) 2: 4G SIM (USIM and ISIM applications present) |

11.4.4 Notes

SARA-R422 / SARA-R422M8S / SARA-R422S

- <state>=2 (4G SIM) is not supported.

11.5 UICC application discovery +CUAD

| +CUAD | | | | | | |
|------------|-----------------------------------|--------------|----------------|----------------|---------------|-----------------|
| Modules | SARA-R422 SARA-R422M8S SARA-R422S | | | | | |
| Attributes | Syntax | PIN required | Settings saved | Can be aborted | Response time | Error reference |
| | full | No | No | No | - | +CME Error |

11.5.1 Description

Asks the MT to discover what applications are available for selection on the UICC. According to ETSI TS 102.221 [150], the ME shall access and read the EF_{DIR} file in the UICC and return the values that are stored in its records. Each record contains the AID and optionally application parameters of one of the applications available on the UICC.

If the optional parameter(s) are requested and the EF_{DIR} file is not present in the UICC, the <response> parameter shall be empty.

11.5.2 Syntax

| Type | Syntax | Response | Example |
|------|--------------------|--|-----------|
| Set | AT+CUAD[=<option>] | +CUAD: <response>[,<active_application>[,<AID>]] | AT+CUAD=1 |

| Type | Syntax | Response | Example |
|------|-----------|--|--|
| | OK | OK | +CUAD: 61124F10A0000000 871002FFFFFFFF89060400 FFFFFFFFFFFFFFFFFFFFFFFF9 000,2,A000000087100 2FFFFFFFF89060400FF OK |
| Test | AT+CUAD=? | +CUAD: (list of supported <option>s) OK | +CUAD: (0,1) OK |

11.5.3 Defined values

| Parameter | Type | Description |
|----------------------|--------|--|
| <option> | Number | <ul style="list-style-type: none"> 0 (default value): no parameters requested in addition to <response> 1: include <active_application> |
| <response> | String | Content of the EF _{DIR} in hexadecimal format |
| <active_application> | Number | Active application: <ul style="list-style-type: none"> 0: no SIM or USIM active 1: active application is SIM 2: active application is USIM, followed by <AID> 3: active application is ISIM, followed by <AID> |
| <AID> | String | AID of active USIM in hexadecimal format |

11.5.4 Notes

SARA-R4

- The <option> parameter is not supported, therefore the module returns only the <response> parameter in the information text response to the set command.
- The test command is not supported.
- Each EF_{DIR} file record is returned within quotation marks; e.g:

```
+CUAD: "61204F10A0000000871002FF33FFF8906030100500C47454E45524943205553494DFFFFFFF
F""61194F0CA000000063504B43532D313550094D49445066696C6573FFFFFFFFFFFFFFFFFFFFFFF"
```

11.6 SIM states reporting +USIMSTAT

| +USIMSTAT | | | | | | |
|-------------------|---|---------------------|-----------------------|-----------------------|----------------------|------------------------|
| Modules | SARA-R410M-02B SARA-R410M-52B SARA-R410M-63B SARA-R410M-73B SARA-R410M-83B SARA-R412M SARA-R422 SARA-R422M8S SARA-R422S SARA-N4 | | | | | |
| Attributes | Syntax | PIN required | Settings saved | Can be aborted | Response time | Error reference |
| | partial | No | NVM | No | - | +CME Error |

11.6.1 Description

Configures the +UUSIMSTAT URC presentation. Based on the configuration, the URC is able to report the SIM card initialization status, the phonebook initialization status and the REFRESH proactive command execution result.



If <state> 9 and 10 are reported, update all SIM card related parameters cached in the DTE's application (e.g. the IMSI retrieved with +CIMI command).

11.6.2 Syntax

| Type | Syntax | Response | Example |
|------|--------------------|-----------------------------|-------------------------|
| Set | AT+USIMSTAT=<mode> | OK | AT+USIMSTAT=3 OK |
| Read | AT+USIMSTAT? | +USIMSTAT: <mode> OK | +USIMSTAT: 3 OK |

| Type | Syntax | Response | Example |
|------|---------------|--|------------------------|
| Test | AT+USIMSTAT=? | +USIMSTAT: (list of supported <mode>s) OK | +USIMSTAT: (0-7) OK |
| URC | | +UUSIMSTAT: <state> | +UUSIMSTAT: 8 |

11.6.3 Defined values

| Parameter | Type | Description |
|-----------|--------|---|
| <mode> | Number | Bitmask representing which indications the +UUSIMSTAT URC is allowed to report. See Table 10 for the meaning of each bit. The factory-programmed value is 0. |
| <state> | Number | Indicates the SIM card initialization status, the phonebook initialization status and the REFRESH proactive command execution result: <ul style="list-style-type: none"> • 0: SIM card not present • 1: PIN needed • 2: PIN blocked • 3: PUK blocked • 4: (U)SIM not operational • 5: (U)SIM in restricted use (FDN or BDN active) • 6: (U)SIM operational (registration may be initiated) • 7: SIM phonebook ready to be used (when the SIM application is active) • 8: USIM phonebook ready to be used (when the USIM application is active) • 9: (U)SIM toolkit REFRESH proactive command successfully concluded • 10: (U)SIM toolkit REFRESH proactive command unsuccessfully concluded • 11: PPP connection active, (U)SIM toolkit REFRESH proactive command delayed till PPP deactivation • 12: voice call active, (U)SIM toolkit REFRESH proactive command delayed till call release • 13: CSD call active, (U)SIM toolkit REFRESH proactive command delayed till call release Allowed values: <ul style="list-style-type: none"> • SARA-R4 / SARA-N4 - 9, 10 |

11.6.4 Notes

- <state>=9 and 10 will not be reported when dedicated (**+CFUN: 6**) or raw (**+CFUN: 9**) mode is active.
- [Table 10](#) provides the meaning of each bit with the corresponding state:

| Bit | States reported |
|-----|--|
| 0 | Reports the (U)SIM initialization status (<state>'s from 0 to 6 may be reported) |
| 1 | Reports the (U)SIM phonebook initialization status (<state>'s from 7 to 8 may be reported) |
| 2 | Reports the (U)SIM toolkit REFRESH proactive command execution result (<state>'s from 9 to 13 may be reported) |

Table 10: <mode> bitmask meaning

SARA-R4 / SARA-N4

- Only <mode>=4 is supported and its factory-programmed value. By factory-programmed configuration the +USIMSTAT URCs are disabled: for more details on enabling / disabling the +USIMSTAT URCs, see the **+UCUSATA** AT command.

12 SIM toolkit

12.1 Introduction

SIM Application Toolkit (STK) is the 3GPP standard feature that allows the Subscriber Identity Module (SIM) to handle the DCE, also by giving commands such as displaying menus and/or asking for user input, and control its access to the network.



SARA-R4 / SARA-N4

Once SIM toolkit interface has been enabled by means of **+UCUSATA** AT command, the DTE is notified SIM toolkit commands and events via URC. User interaction is usually not required, as the module handles Terminal Responses autonomously.

SIM toolkit processing supports two modes: dedicated and raw. In dedicated mode, the DTE is notified of STK commands and events after decoding; in raw mode the DTE receives the raw data as received from the SIM. Only one mode can be enabled and function at a time.

For more details on the command description and parameters, see 3GPP TS 51.014 [86].



The setup menu fetched from the SIM card may vary with the terminal profile supported by the MT, which is affected by the capabilities of the module itself (e.g. speech): this implies that different u-blox modules may display different setup menus with the same SIM card.



The commands in this section properly work only if the SIM toolkit interface has been activated by the DTE. Otherwise the SIM toolkit processing will be blocked.



If an AT command related to the dedicated mode is used when the raw mode is enabled (and vice versa), an error result code ("CME ERROR: operation not allowed" if **+CMEE** is set to 2) is returned.

The STK commands related to the Bearer Independent Protocol, i.e. Open Channel, Close Channel, Receive Data, Send Data, Get Channel Status and the events Data Available and Channel Status, are autonomously managed by the device without the intervention from the TE, unless the dedicated mode is active and the Open Channel command requires the user intervention (see ETSI TS 102 223 [149]).

12.2 Bearer Independent Protocol status indication +UBIP

| +UBIP | | | | | | |
|-------------------|---|---------------------|-----------------------|-----------------------|----------------------|------------------------|
| Modules | SARA-R410M-02B SARA-R410M-52B SARA-R410M-63B SARA-R410M-73B SARA-R410M-83B SARA-R412M SARA-R422 SARA-R422M8S SARA-R422S SARA-N4 | | | | | |
| Attributes | Syntax | PIN required | Settings saved | Can be aborted | Response time | Error reference |
| | full | No | NVM | No | - | +CME Error |

12.2.1 Description

Configures the Bearer Independent Protocol status indication, i.e. the +UUBIP URC presentation.



The channel status event provides information about the link status and its drop, therefore it is advisable to enable it where available.



SARA-R410M-02B / SARA-R410M-52B / SARA-R410M-63B / SARA-R410M-73B / SARA-R410M-83B / SARA-R412M / SARA-N4

The command setting is not stored in the NVM.

12.2.2 Syntax

| Type | Syntax | Response | Example |
|------|----------------|-------------------------------------|-----------------|
| Set | AT+UBIP=<mode> | OK | AT+UBIP=1 OK |
| Read | AT+UBIP? | +UBIP: <mode> OK | +UBIP: 0 OK |
| Test | AT+UBIP=? | +UBIP: (list of supported <mode>'s) | +UBIP: (0,1) |

| Type | Syntax | Response | Example |
|------|--------|------------------------|----------------|
| | | OK | OK |
| URC | | +UUBIP: <ev_cmd>,<val> | +UUBIP: 10,261 |

12.2.3 Defined values

| Parameter | Type | Description |
|-----------|--------|---|
| <mode> | Number | Indicates whether the +UUBIP URC is enabled or not: <ul style="list-style-type: none"> 0 (factory-programmed value): BIP status indication disabled 1: BIP status indication enabled 2: OPEN CHANNEL, CLOSE CHANNEL and CHANNEL STATUS EVENT status indications enabled Allowed values: <ul style="list-style-type: none"> SARA-R4 / SARA-N4 - 0, 1 |
| <ev_cmd> | Number | Indicates the event download's tag or proactive command's tag. Allowed values: <ul style="list-style-type: none"> 10: Channel status event 64: Open channel proactive command 65: Close channel proactive command 66: Receive data proactive command 67: Send data proactive command |
| <val> | Number | Indicates the channel status (in case of the event download channel status) or result in case of a proactive command (see ETSI TS 102 223 [149]) |

12.3 Read the USAT profile +CUSATR

| +CUSATR | | | | | | |
|-------------------|---|---------------------|-----------------------|-----------------------|----------------------|------------------------|
| Modules | SARA-R410M-02B SARA-R410M-52B SARA-R410M-63B SARA-R410M-73B SARA-R410M-83B SARA-R412M SARA-R422 SARA-R422M8S SARA-R422S SARA-N4 | | | | | |
| Attributes | Syntax | PIN required | Settings saved | Can be aborted | Response time | Error reference |
| | full | Yes | No | No | - | +CME Error |

12.3.1 Description

Reads the USAT terminal profile for the given profile storage. If the <profile_storage> parameter is omitted in the set command, the information text response will return the profile for all the supported profile storage values.

12.3.2 Syntax

| Type | Syntax | Response | Example |
|------|-------------------------------|--|---|
| Set | AT+CUSATR[=<profile_storage>] | +CUSATR: <profile_storage>, <profile> OK | AT+CUSATR=1 +CUSATR: 1,"F31FE84A119C00 878C00001FE060000043C000000 00040004000000000008" OK |
| Test | AT+CUSATR=? | +CUSATR: (list of supported <profile_storage>s) OK | +CUSATR: (0-5) OK |

12.3.3 Defined values

| Parameter | Type | Description |
|-------------------|--------|--|
| <profile_storage> | Number | Allowed values: <ul style="list-style-type: none"> 0: the TE profile that can be set with the +CUSATW AT command 1: the MT profile that can be set with the +CUSATW AT command 2: MT default profile that reflects the inherent, default supported facilities of the MT 3: UICC profile that reflects the currently active UICC profile that was sent to the UICC in the last TERMINAL PROFILE command |

| Parameter | Type | Description |
|-----------|--------|---|
| | | <ul style="list-style-type: none"> 4: UICC EF_{UST}. It represents the elementary file that indicates services available in the USIM 5: list of MT only facilities (facilities that are not allowed to be assigned to the TE, see 3GPP TS 31.111 [125]) |
| <profile> | String | The profile in hexadecimal character format describing the supported facilities of the referenced <profile_storage> as specified for the Terminal Profile in 3GPP TS 31.111 [125] or for the related EF in 3GPP TS 31.102 [72]. |

12.4 Write the USAT profile +CUSATW

+CUSATW

| Modules | SARA-R410M SARA-R412M SARA-R422 SARA-R422M8S SARA-R422S SARA-N4 | | | | | |
|------------|--|--------------|----------------|----------------|---------------|-----------------|
| Attributes | Syntax | PIN required | Settings saved | Can be aborted | Response time | Error reference |
| | full | Yes | NVM | No | - | +CME Error |

12.4.1 Description

Writes a USAT terminal profile to the profile storage location. If the profile storage parameter is omitted in the set command, it resets the profiles for all the supported profile storage values to factory-programmed setting. If only the profile parameter is omitted, it will reset the given profile storage to factory-programmed setting.



SARA-R410M-02B / SARA-R410M-52B / SARA-R410M-63B / SARA-R410M-73B / SARA-R410M-83B / SARA-R412M / SARA-N4

Upon an attempt to store or reset a profile that conflicts with the list of MT only facilities, or when attempting to activate a profile bit not available in the MT default profile (see [AT+CUSATR=2](#)), the operation fails and the profile referred to by the command parameter <profile_storage> remains unchanged. The MT will provide an error result code.



SARA-R410M-01B

When trying to store or reset a profile that conflicts with an already stored profile or the list of MT only facilities, the operation fails and the profile referred to by the command parameter <profile_storage> remains unchanged. The MT will provide an error result code.

12.4.2 Syntax

| Type | Syntax | Response | Example |
|------|--|---|---|
| Set | AT+CUSATW[=<profile_storage>[, <profile>]] | OK | AT+CUSATW=1,"F31FE84A119C00 878C00001FE060000043C000000 00040004000000000008" OK |
| Test | AT+CUSATW=? | +CUSATW: (list of supported <profile_storage>s) OK | +CUSATW: (0,1) OK |

12.4.3 Defined values

| Parameter | Type | Description |
|-------------------|--------|---|
| <profile_storage> | Number | Allowed values: <ul style="list-style-type: none"> 0: TE. It refers to the profile storage for the facilities supported by the TE. The default value is a blank profile with all bits set to zero. This value is applicable both in the execution command and in the information text response. 1: MT. It refers to the profile storage for the facilities to be supported by the MT, which can be a subset of the default MT facilities. The TE can choose to register a subset of the MT default profile, typically omitting facilities also supported by the TE profile. The default value is the MT default profile. This value is applicable both in the execution command and in the information text response. |
| <profile> | String | The profile in hexadecimal character format describing the supported facilities of the referenced <profile_storage> as specified for the Terminal Profile in 3GPP TS 31.111 [125] or for the related EF in 3GPP TS 31.102 [72]. |

12.5 Enable USAT terminal URCs +UCUSATA

| +UCUSATA | | | | | | |
|-------------------|---|---------------------|-----------------------|-----------------------|----------------------|----------------------------|
| Modules | SARA-R410M-02B SARA-R410M-52B SARA-R410M-63B SARA-R410M-73B SARA-R410M-83B SARA-R412M SARA-R422 SARA-R422M8S SARA-R422S SARA-N4 | | | | | |
| Attributes | Syntax | PIN required | Settings saved | Can be aborted | Response time | Error reference |
| | full | No | NVM | No | - | +CME Error |

12.5.1 Description

Enables the USAT terminal URCs to the TE for USAT proactive commands sent from the UICC to the MT.

12.5.2 Syntax

| Type | Syntax | Response | Example |
|------|-------------------------|--|-----------------------|
| Set | AT+UCUSATA=<active_URC> | OK | AT+UCUSATA=0 OK |
| Read | AT+UCUSATA? | +UCUSATA: <active_URC> OK | +UCUSATA: 0 OK |
| Test | AT+UCUSATA=? | +UCUSATA: (list of supported <active_URC>s) OK | +UCUSATA: (0-7) OK |
| URC | | +CUSATP: <proactive_command> | |
| URC | | +CUSATEND | |

12.5.3 Defined values

| Parameter | Type | Description |
|---------------------|--------|---|
| <active_URC> | Number | Bitmask representing which URCs are activated. See Table 11 for the meaning of each bit. The factory-programmed value is 0. |
| <proactive_command> | String | Command in hexadecimal character format. Proactive command as defined in 3GPP TS 31.111 [125] , consisting of the full BER-TLV data object. |

12.5.4 Notes

- The MT issues the +CUSATP URC to forward to the TE proactive commands issued by the UICC.
- The MT issues the +CUSATEND URC when the UICC indicates that the proactive command session is terminated.
- [Table 11](#) provides the meaning of each bit with the corresponding state:

| Bit | States reported |
|-----|---|
| 0 | Enable the +CUSATEND URC |
| 1 | Enable the +CUSATP URC |
| 2 | Enable the +UUSIMSTAT URC |

Table 11: <mode> bitmask meaning

13 Packet switched data services

13.1 PDP contexts and parameter definition

13.1.1 Primary and secondary PDP contexts

A PDP context can be either **primary** or **secondary**. In LTE, PS data connections are referred to as EPS bearers: EPS bearers are conceptually equivalent to the legacy PDP contexts, which are often referred to for sake of simplicity. Similarly to a PDP context, the EPS bearer can be a default (primary) or dedicated (secondary) one. The initial EPS bearer established during LTE attach procedure is actually a default EPS bearer. A secondary PDP context uses the same IP address of a primary PDP context (the usual PDP context activated e.g. via dial-up). The Traffic Flow Filters for such secondary contexts shall be specified according to 3GPP TS 23.060 [65].

The typical usage of the secondary PDP contexts is in VoIP calls, where RTP (speech) packets are conveyed on one PDP context (e.g. the primary one) with a given QoS (e.g. low reliability) whereas SIP signalling is routed on a different PDP context (e.g. the secondary one, with the same IP address but different port numbers) with a more reliable QoS.

A Traffic Flow Template (i.e. a filter based on port number, specifying relative flow precedence) shall be configured for the secondary context to instruct the GGSN to route down-link packets onto different QoS flows towards the TE.

| PDP context type | Activation procedure |
|------------------|--|
| Primary | Used to establish a logical connection through the network from the UE to the GGSN with a specifically negotiated Quality of Service (QoS). The UE initiates the PDP context activation: it changes the session management state to active, creates the PDP context, obtains the IP address and reserves radio resources. After the activation, the UE is able to send IP packets over the air interface. |
| Secondary | Used to establish a second PDP context with the same IP address and the same APN as the primary PDP context. The two contexts may have different QoS profiles, which makes the feature useful for applications that have different QoS requirements (e.g. IP multimedia); QoS is applied based on port number addressing. |



SARA-R4 / SARA-N4

Mobile originated activation of secondary PDP contexts is not supported.

13.1.2 Multiple PDP contexts

Two PDP context types are defined:

- "external" PDP context: IP packets are built by the DTE, the MT's IP instance runs the IP relay function only;
- "internal" PDP context: the PDP context (relying on the MT's embedded TCP/IP stack) is configured, established and handled via the data connection management AT commands.

Multiple PDP contexts are supported. The DTE can access these PDP contexts either alternatively through the physical serial interface, or simultaneously through the virtual serial ports of the multiplexer (multiplexing mode MUX), with the following constraints:

- Using the MT's embedded TCP/IP stack, only a internal PDP context is supported. This IP instance supports up to 7 sockets;
- The sum of active external and internal PDP contexts cannot exceed the maximum number of active PDP contexts indicated in the <cid> parameter description;
- Using external PDP contexts via dial-up, it is usually possible to have at most 3 PPP instances simultaneously active.



SARA-R404M / SARA-R410M-01B / SARA-R410M-52B / SARA-R410M-63B / SARA-R410M-73B / SARA-R410M-83B / SARA-N4

Using external PDP contexts via dial-up, it is possible to have a single PPP instance active.



SARA-R410M-02B / SARA-R412M

On SARA-R410M-02B-00, SARA-R410M-02B-01, SARA-R410M-02B-02, SARA-R412M-02B-00, SARA-R412M-02B-01, SARA-R412M-02B-02 using external PDP contexts via dial-up, it is possible to have a single PPP instance active.

13.1.3 Parameter definition

13.1.3.1 <APN>

The Access Point Name (APN) is a string parameter, which is a logical name, valid in the current PLMN's domain, used to select the GGSN (Gateway GPRS Support Node) or the external packet data network to be connected to. The APN can be omitted: this is the so-called "blank APN" setting that may be suggested by network operators (e.g. to roaming devices); in this case the APN string is not included in the message sent to the network.

The maximum length of the parameter is:

- SARA-R4 / SARA-N4 - 62 characters

13.1.3.2 <cid>

PDP context identifier. A numeric parameter specifying a particular PDP context definition. This parameter is valid only locally on the interface DTE-MT.

The maximum number of definable and active PDP contexts depend(s) on the product version:²

| Product | Max number of definable PDP contexts | Max number of active PDP contexts |
|--|--------------------------------------|-----------------------------------|
| SARA-R404M / SARA-R410M / SARA-R412M / SARA-N4 | 8 | 8 |
| SARA-R422 / SARA-R422M8S / SARA-R422S | 8 | 4 |

13.1.3.3 <PDP_addr>

String parameter identifying the MT in the IP-address space applicable to the PDP service. If the value is null or omitted (dynamic IP addressing), then a value may be provided by the DTE during the PDP startup procedure or, failing that, a dynamic address will be requested via DHCP. It can be read with the command [AT+CGPADDR](#) or [AT+CGDCONT](#) read command.

To request a static IP address, a fixed IP address shall be specified for the <PDP_addr> parameter of the [+CGDCONT](#) set command and the user shall not rely on PPP negotiation via IPCP CONFREQ option.

Depending on the IP-version, the <PDP_addr> consists of 4 octets (IPv4) or 16 octets (IPv6):

- IPv4: "ddd.ddd.ddd.ddd"
- IPv4v6: "ddd.ddd.ddd.ddd ddd.ddd.ddd.ddd.ddd.ddd.ddd.ddd.ddd.ddd.ddd.ddd.ddd.ddd"
- IPv6: "ddd.ddd.ddd.ddd.ddd.ddd.ddd.ddd.ddd.ddd.ddd.ddd.ddd.ddd.ddd.ddd"

13.1.3.4 <PDP_type>

The Packet Data Protocol (PDP) type is a string parameter which specifies the type of packet data protocol:

- "IP": Internet Protocol (IETF STD 5)
- "NONIP": Non IP
- "IPV4V6": virtual <PDP_type> introduced to handle dual IP stack UE capability (see the 3GPP TS 24.301 [102])
- "IPV6": Internet Protocol, version 6 (see RFC 2460 [159])

 SARA-R404M / SARA-R410M-01B / SARA-R410M-52B
<PDP_type>="NONIP" is not supported.

 SARA-R410M-02B
<PDP_type>="NONIP" is not supported by SARA-R410M-02B-00.

13.2 PPP LCP handshake behaviour

When a data call is initiated by means of **D*** AT command, the module switches to PPP mode just after the CONNECT intermediate result code. The first step of the PPP procedure is the LCP handshake, in this phase the behaviour of module series differ between them.

² The maximum number of active PDP contexts may be limited by the MNO



Entering OnLine Command Mode (OLCM) during LCP handshake phase is strongly discouraged because the handshake procedure could be broken and should be restarted from the beginning.

13.3 Printing IP address format +CGPIAF

| +CGPIAF | | | | | | |
|-------------------|---|---------------------|-----------------------|-----------------------|----------------------|------------------------|
| Modules | SARA-R410M-02B SARA-R410M-52B SARA-R410M-63B SARA-R410M-73B SARA-R410M-83B SARA-R412M SARA-R422 SARA-R422M8S SARA-R422S SARA-N4 | | | | | |
| Attributes | Syntax | PIN required | Settings saved | Can be aborted | Response time | Error reference |
| | full | Yes | No | No | - | +CME Error |

13.3.1 Description

Defines the printing format of IPv6 address parameters of the other AT commands. See RFC 4291 [164] for details of the IPv6 address format.



SARA-R4 / SARA-N4
The affected parameters are:

- In **+CGDCONT** the <PDP_addr> parameter
- In **+CGPADDR** the <PDP_addr_1> and <PDP_addr_2> parameters
- In **+CGCONTRDP**, the <local_address_and_subnet_mask>, <dns_prim_addr>, <dns_sec_addr>, <P_CSCF_prim_addr> and <P_CSCF_sec_addr> parameters

13.3.2 Syntax

| Type | Syntax | Response | Example |
|------|---|---|--|
| Set | AT+CGPIAF=[<IPv6_AddressFormat>[,<IPv6_SubnetNotation>[,<IPv6_LeadingZeros>[,<IPv6_CompressZeros>]]]] | OK | AT+CGPIAF=1,1,1,1 OK |
| Read | AT+CGPIAF? | +CGPIAF: <IPv6_AddressFormat>, <IPv6_SubnetNotation>, <IPv6_LeadingZeros>, <IPv6_CompressZeros> OK | +CGPIAF: 0,0,0,0 OK |
| Test | AT+CGPIAF=? | +CGPIAF: (list of supported <IPv6_AddressFormat>s), (list of supported <IPv6_SubnetNotation>s), (list of supported <IPv6_LeadingZeros>s), (list of supported <IPv6_CompressZeros>s) OK | +CGPIAF: (0-1),(0-1),(0-1),(0-1) OK |

13.3.3 Defined values

| Parameter | Type | Description |
|-----------------------|--------|--|
| <IPv6_AddressFormat> | Number | Defines the IPv6 address format: <ul style="list-style-type: none"> • 0 (default value): IPv4-like dot-notation used. IP address and subnetwork mask if applicable, are dot-separated • 1: IPv6-like colon-notation used. IP address and subnetwork mask if applicable and when given explicitly, are separated by a space |
| <IPv6_SubnetNotation> | Number | Defines the subnet-notation for <remote_address_and_subnet_mask>. The setting does not apply if <IPv6_AddressFormat>=0: <ul style="list-style-type: none"> • 0 (default value): both IP address and subnet mask are explicitly stated, separated by a space • 1: the printout format is applying / (forward slash) subnet-prefix Classless Inter-Domain Routing (CIDR) |

| Parameter | Type | Description |
|----------------------|--------|--|
| <IPv6_LeadingZeros> | Number | Defines whether leading zeros are omitted or not. The setting does not apply if <IPv6_AddressFormat>=0: <ul style="list-style-type: none"> 0 (default value): leading zeros omitted 1: leading zeros included |
| <IPv6_CompressZeros> | Number | Defines whether 1-n instances of 16-bit-zero-values are replaced by only "::". This applies only once. The setting does not apply if <IPv6_AddressFormat>=0: <ul style="list-style-type: none"> 0 (default value): no zero compression 1: use zero compression |

13.4 PDP context definition +CGDCONT

| +CGDCONT | | | | | | |
|------------|--------------|--------------|----------------|----------------|---------------|-----------------|
| Modules | All products | | | | | |
| Attributes | Syntax | PIN required | Settings saved | Can be aborted | Response time | Error reference |
| | partial | Yes | NVM / OP | No | - | +CME Error |

13.4.1 Description

Defines the connection parameters for a PDP context, identified by the local context identification parameter <cid>. If the command is used only with parameter <cid>, the corresponding PDP context becomes undefined.

Each context is permanently stored so that its definition is persistent over power cycles.

The command is used to set up the PDP context parameters for an external context, i.e. a data connection using the external IP stack (e.g. Windows dial-up) and PPP link over the serial interface.

Usage of static i.e. user defined IP address is possible in UTRAN and GERAN but not in EUTRAN; to prevent inconsistent addressing methods across various RATs, static IP addressing is not recommended for LTE modules: 3GPP TS 23.060 [65] Rel.8 and later releases specify that a UE with EUTRAN/UTRAN/GERAN capabilities shall not include a static PDP address in PDP context activation requests.

The information text response to the read command provides the configuration of all the PDP context / EPS bearers that have already been defined. The test command returns a different row for each <PDP_type> value supported by the module.



SARA-R410M-02B / SARA-R410M-52B / SARA-R410M-63B / SARA-R410M-73B / SARA-R410M-83B / SARA-R412M / SARA-R422 / SARA-R422M8S / SARA-R422S / SARA-N4

After the PDP context activation, the information text response to the read command provides the configuration negotiated with the network (similarly to +CGCONTRDP AT command).

13.4.2 Syntax

| Type | Syntax | Response | Example |
|------|--|---|---|
| Set | AT+CGDCONT=[<cid>[,<PDP_type>[,<APN>[,<PDP_addr>[,<d_comp>[,<h_comp>[,<IPv4AddrAlloc>[,<emergency_indication>[,<P-CSCF_discovery>[,<IM_CN_Signalling_Flag_Ind>[,<NSLPI>]]]]]]]]]]] | OK | <p>IPv4 example</p> <p>AT+CGDCONT=1,"IP","APN_name", "1.2.3.4",0,0</p> <p>OK</p> <p>IPv4v6 example</p> <p>AT+CGDCONT=1,"IPV4V6","APN","0.0.0.0 0.0.0.0 0.0.0.0 0.0.0.0 0.0.0.0 0.0.0.0",0,0</p> <p>OK</p> <p>IPv6 example</p> <p>AT+CGDCONT=1,"IPV6","APN","0.0.0.0 0.0.0.0 0.0.0.0 0.0.0.0",0,0</p> <p>OK</p> |
| Read | AT+CGDCONT? | +CGDCONT: <cid>,<PDP_type>,<APN>,<PDP_addr>,<d_comp>,<h_comp>[,<IPv4AddrAlloc>,<emergency_indication>[,<P-CSCF_ | +CGDCONT: 1,"IP","web.omnitel.it", "91.80.140.199",0,0 |

| Type | Syntax | Response | Example |
|------|--------------|--|--|
| | | discovery>,<IM_CN_Signalling_Flag_Ind>[,<NSLPI>]]] [+CGDCONT: <cid>,<PDP_type>,<APN>,<PDP_addr>,<d_comp>,<h_comp>[,<IPv4AddrAlloc>,<emergency_indication>[,<P-CSCF_discovery>,<IM_CN_Signalling_Flag_Ind>[,<NSLPI>]]]] OK | |
| Test | AT+CGDCONT=? | +CGDCONT: (list of supported <cid>s),<PDP_type>,,,(list of supported <d_comp>s),(list of supported <h_comp>s)[,(list of supported <IPv4AllocAddr>s),(list of supported <emergency_indication>s)[,(list of supported <P-CSCF_discovery>s),(list of supported <IM_CN_Signalling_Flag_Ind>s)[,(list of supported <NSLPI>s)]]] [+CGDCONT: (list of supported <cid>s),<PDP_type>,,,(list of supported <d_comp>s),(list of supported <h_comp>s)[,(list of supported <IPv4AllocAddr>s),(list of supported <emergency_indication>s)[,(list of supported <P-CSCF_discovery>s),(list of supported <IM_CN_Signalling_Flag_Ind>s)[,(list of supported <NSLPI>s)]]]] OK | +CGDCONT: (1-3,"IP",,,(0-2),(0-4) +CGDCONT: (1-3,"IPv6",,,(0-2),(0-4) OK |

13.4.3 Defined values

| Parameter | Type | Description |
|------------------------|--------|--|
| <cid> | Number | See <cid>. The default value is 1. |
| <PDP_type> | String | See <PDP_type>. The default value is "IP". |
| <APN> | String | See <APN>. The default value is "" (blank APN). |
| <PDP_addr> | Number | See <PDP_addr>. The default value is "0.0.0.0" |
| <d_comp> | Number | PDP data compression; it can have the values: <ul style="list-style-type: none"> • 0 (default value): off • 1: on (predefined compression type i.e. V.42bis data compression) • 2: V.42bis data compression • 3: V.44 |
| <h_comp> | Number | PDP header compression; it can have the values: <ul style="list-style-type: none"> • 0 (default value): off • 1: on (predefined compression type, i.e. RFC1144) • 2: RFC1144 • 3: RFC2507 • 4: RFC3095  <h_comp>: the available head-compressions are dependent on configuration of the stack (configured via features in the stack) |
| <IPv4AddrAlloc> | Number | Controls how the MT/TA requests to get the IPv4 address information: <ul style="list-style-type: none"> • 0 (default value): IPv4 Address Allocation through NAS Signalling • 1: IPv4 Address Allocated through DHCP |
| <emergency_indication> | Number | Indicates whether the PDP context is for emergency bearer services or not: <ul style="list-style-type: none"> • 0 (default value): PDP context is not for emergency bearer services • 1: PDP context is for emergency bearer services |
| <request_type> | Number | Indicates the type of PDP context activation request for the PDP context: |

| Parameter | Type | Description |
|-----------------------------|--------|---|
| | | <ul style="list-style-type: none"> 0: PDP context is for new PDP context establishment or for handover from a non-3GPP access network (how the MT decides whether the PDP context is for new PDP context establishment or for handover is implementation specific) 1: PDP context is for emergency bearer services 2 (default value): PDP context is for new PDP context establishment 3: PDP context is for handover from a non-3GPP access network |
| <P-CSCF_discovery> | Number | Influences how the MT/TA requests to get the P-CSCF address, see 3GPP TS 24.229 [113] annex B and annex L: <ul style="list-style-type: none"> 0 (default value): preference of P-CSCF address discovery not influenced by +CGDCONT 1: preference of P-CSCF address discovery through NAS Signalling 2: preference of P-CSCF address discovery through DHCP |
| <IM_CN_Signalling_Flag_Ind> | Number | Shows whether the PDP context is for IM CN subsystem-related signalling only or not: <ul style="list-style-type: none"> 0: PDP context is not for IM CN subsystem-related signalling only 1: PDP context is for IM CN subsystem-related signalling only |
| <NSLPI> | Number | Indicates the NAS signalling priority requested for the corresponding PDP context: <ul style="list-style-type: none"> 0 (default value): indicates that the PDP context has to be activated with the value for the low priority indicator configured in the MT. 1: indicates that the PDP context has to be activated with the value for the low priority indicator set to "MS is not configured for NAS signalling low priority". The MT utilises the NSLPI information provided as specified in 3GPP TS 24.301 [102] and 3GPP TS 24.008 [67]. |
| <secure_PCO> | Number | Specifies if security protected transmission of PCO is requested or not (applicable for EPS only): <ul style="list-style-type: none"> 0 (default value): Security protected transmission of PCO is not requested. 1: Security protected transmission of PCO is requested. |
| <IPv4_MTU_discovery> | Number | Influences how the MT/TA requests to get the IPv4 MTU size: <ul style="list-style-type: none"> 0 (default value): Preference of IPv4 MTU size discovery not influenced by +CGDCONT. 1: Preference of IPv4 MTU size discovery through NAS signalling. |
| <Local_Addr_Ind> | Number | Indicates to the network whether or not the MS supports local IP address in TFTs: <ul style="list-style-type: none"> 0 (default value): indicates that the MS does not support local IP address in TFTs. 1: indicates that the MS supports local IP address in TFTs. |
| <Non_IP_MTU_discovery> | Number | Influences how the MT/TA requests to get the Non-IP MTU size (for more details, see 3GPP TS 24.008 [67]): <ul style="list-style-type: none"> 0 (default value): preference of Non-IP MTU size discovery not influenced by +CGDCONT. 1: preference of Non-IP MTU size discovery through NAS signalling. |

13.4.4 Notes

Additional examples:

| Command | Response | Description |
|---------------------------------|--|---|
| | | Configure the error result code format by means of the +CMEE AT command |
| AT+CGDCONT=? | +CGDCONT: (1-3),"IP",,(0),(0-1) OK | Test command |
| AT+CGDCONT=4,"IP","internet" | +CME ERROR: operation not allowed | Define out of range PDP contexts |
| AT+CGDCONT=2,"IP","internet" | OK | Define allowed PDP contexts |
| AT+CGDCONT=1,"IP","STATREAL" | OK | Define allowed PDP contexts |
| AT+CGDCONT=3,"IP","tim.ibox.it" | OK | Define allowed PDP contexts |
| AT+CGDCONT=253,"IP","internet" | +CME ERROR: operation not allowed | Define out of range PDP contexts |
| AT+CGDCONT? | +CGDCONT: 2,"IP","internet","0.0.0.0",0,0 +CGDCONT: 1,"IP","STATREAL","0.0.0.0",0,0 +CGDCONT: 3,"IP","tim.ibox.it","0.0.0.0",0,0 OK | Read command |

SARA-R4 / SARA-N4

- The factory-programmed settings of the initial default EPS bearer mapped to <cid>=1 are:
 - <APN> see [Mobile Network Operator profiles](#).
 - <PDP_addr>="0.0.0.0 0.0.0.0.0.0.0.0.0.0.0.0.0.0"
 - <PDP_type>="IPV4V6"
- If <PDP_type>="IPV6", the <PDP_addr> parameter is mandatory and the allowed values are "" (blank) or a full 8 octets with colon separated format address.
- <d_comp>=1, 2, 3 are not supported.
- The command setting are stored in the NVM at the module switch off.
- The module automatically accepts Mobile Terminated PDP contexts/EPS bearers.
- The <NSLPI> parameter is not supported.
- <h_comp>=1, 2, 3 and 4 are not supported.
- If <PDP_addr> is not assigned or set to all zeros and <PDP_type>="IPV4V6", the read command will only return the all zeros IPV6 address.

SARA-R422 / SARA-R422M8S / SARA-R422S

- Defining different PDP contexts with the same <APN> and <PDP_type> is not allowed.
- The <emergency_indication>, <P-CSCF_discovery> and <IM_CN_Signalling_Flag_Ind> parameters are not supported.

SARA-R410M-63B / SARA-R410M-73B / SARA-R410M-83B

- The <P-CSCF_discovery> and <IM_CN_Signalling_Flag_Ind> parameters are not supported.

SARA-R410M-02B

- On SARA-R410M-02B-00, SARA-R410M-02B-01, SARA-R410M-02B-02 the <P-CSCF_discovery> and <IM_CN_Signalling_Flag_Ind> parameters are not supported.
- Except on SARA-R410M-02B-00, SARA-R410M-02B-01, SARA-R410M-02B-02, in all the [+UMNOPROF](#) AT command configuration, except for the Verizon (see the [+UMNOPROF](#) AT command, <MNO>=3) configuration, the +CGDCONT entries are synchronized at power on to the entries of the LwM2M object 11 "APN connection profile" instances. Update of instances in LwM2M database (see [Lightweight M2M](#)) will cause update of the +CGDCONT entries. Create / delete / update of EPS bearers by means of the +CGDCONT AT command will cause create / delete / update of instances in LwM2M database (see [Lightweight M2M](#)). It is possible for the LwM2M AT&T server to disable a certain APN by setting resource 3 "APN Enable status" to "false". This would cause the corresponding APN to be deactivated automatically and its activation, triggered by any client including [AT+CGACT](#), will be locally rejected.
- In Verizon configuration (see the [+UMNOPROF](#) AT command, <MNO>=3) the EPS bearers with the <cid> parameter in range from 1 to 7 are defined by default and are aligned to the entries of the Verizon APN table (see the [+VZWAPNE](#) AT command).

SARA-R412M

- On SARA-R412M-02B-00, SARA-R412M-02B-01, SARA-R412M-02B-02 the <P-CSCF_discovery> and <IM_CN_Signalling_Flag_Ind> parameters are not supported.
- Except on SARA-R412M-02B-00, SARA-R412M-02B-01, SARA-R412M-02B-02, in all the [+UMNOPROF](#) AT command configuration, the +CGDCONT entries are synchronized at power on to the entries of the LwM2M object 11 "APN connection profile" instances. Update of instances in LwM2M database (see [Lightweight M2M](#)) will cause update of the +CGDCONT entries. Create / delete / update of EPS bearers by means of the +CGDCONT AT command will cause create / delete / update of instances in LwM2M database (see [Lightweight M2M](#)). It is possible for the LwM2M AT&T server to disable a certain APN by setting resource 3 "APN Enable status" to "false". This would cause the corresponding APN to be deactivated automatically and its activation, triggered by any client including [AT+CGACT](#), will be locally rejected.

SARA-R410M-01B / SARA-R410M-52B / SARA-N4

- The <P-CSCF_discovery> and <IM_CN_Signalling_Flag_Ind> parameters are not supported.
- In Verizon configuration (see the [+UMNOPROF](#) AT command, <MNO>=3 where supported) the EPS bearers with the <cid> parameter in range from 1 to 7 are defined by default and are aligned to the entries of the Verizon APN table (see the [+VZWAPNE](#) AT command).

SARA-R404M

- The <P-CSCF_discovery> and <IM_CN_Signalling_Flag_Ind> parameters are not supported.

- The settings of the initial default EPS bearer mapped to <cid>=1 must have a blank APN.
- In Verizon configuration the EPS bearers with the <cid> parameter in range from 1 to 7 are defined by default and are aligned to the entries of the Verizon APN table (see the [+VZWAPNE](#) AT command).

13.5 Packet switched data configuration +UPSD

| +UPSD | | | | | | |
|-------------------|---------------|---------------------|-----------------------|-----------------------|----------------------|------------------------|
| Modules | All products | | | | | |
| Attributes | Syntax | PIN required | Settings saved | Can be aborted | Response time | Error reference |
| | partial | No | +UPSDA | No | - | +CME Error |

13.5.1 Description

Sets or reads all the parameters in a specific packet switched data (PSD) profile. The command is used to set up the PDP context parameters for an internal context, i.e. a data connection using the internal IP stack and related AT commands for sockets.

To set all the parameters of the PSD profile a set command for each parameter needs to be issued.



In the read command, if only the first parameter is issued, the module returns all the parameters of the given PSD profile, and lists them in separated lines.



SARA-R4 / SARA-N4

The command setting is stored in the NVM following the procedure described in the [Saving AT commands configuration](#) section.

13.5.2 Syntax

| Type | Syntax | Response | Example |
|------|--|--|---|
| Set | AT+UPSD=<profile_id>,<param_tag>,<param_val> | OK | AT+UPSD=0,1,"apn.provider.com" OK |
| Read | AT+UPSD=<profile_id>,<param_tag> | +UPSD: <profile_id>,<param_tag>,<param_val> OK | AT+UPSD=0,1 +UPSD: 0,1,"apn.provider.com" OK |
| | AT+UPSD=<profile_id> | +UPSD: <profile_id>,0,<param_val0> > +UPSD: <profile_id>,1,<param_val1>... +UPSD: <profile_id>,x,<param_valx> OK | AT+UPSD=0 +UPSD: 0,0,0 +UPSD: 0,1,"apn.provider.com" +UPSD: 0,2,"username" +UPSD: 0,4,"0.0.0.0" ... +UPSD: 0,19,0 OK |

13.5.3 Defined values

| Parameter | Type | Description |
|--------------|--------|--|
| <profile_id> | Number | PSD profile identifier. Allowed values: <ul style="list-style-type: none"> • SARA-R4 / SARA-N4 - 0 |
| <param_tag> | Number | Allowed values: <ul style="list-style-type: none"> • 0: protocol type - the allowed values of <param_val> parameter are: <ul style="list-style-type: none"> o 0 (default value): IPv4 o 1: IPv6 o 2: IPv4v6 with IPv4 preferred for internal sockets o 3: IPv4v6 with IPv6 preferred for internal sockets • 1: APN - <param_val> defines the APN text string, e.g. "apn.provider.com"; the maximum length is 99. The default value is an empty string. • 2: username - <param_val> is the user name text string for the authentication phase. The default value is an empty string. The maximum length is 64 characters. |

| Parameter | Type | Description |
|-----------|------|---|
| | | <ul style="list-style-type: none"> • 3: password - <param_val> is the password text string for the authentication phase. Note: the AT+UPSD read command with <param_tag> = 3 is not allowed and the read all command does not display it. The maximum length is 64 characters. • 4: DNS1 - <param_val> is the text string of the primary DNS address. IPv4 DNS addresses are specified in dotted decimal notation form (i.e. four numbers in range 0-255 separated by periods, e.g. "xxx.yyy.zzz.www"). IPv6 DNS addresses are specified in standard IPv6 notation form (2001:DB8:: address compression is allowed). The default value is "0.0.0.0". • 5: DNS2 - <param_val> is the text string of the secondary DNS address. IPv4 DNS addresses are specified in dotted decimal notation form (i.e. four numbers in range 0-255 separated by periods, e.g. "xxx.yyy.zzz.www"). IPv6 DNS addresses are specified in standard IPv6 notation form (2001:DB8:: address compression is allowed). The default value is "0.0.0.0". • 6: authentication - the <param_val> parameter selects the authentication type: <ul style="list-style-type: none"> o 0 (default value): none o 1: PAP o 2: CHAP o 3: automatic selection of authentication type (none/CHAP/PAP) • 7: IP address - <param_val> is the text string of the static IP address given by the ISP in dotted decimal notation form (i.e. four numbers in range 0-255 separated by periods, e.g. "xxx.yyy.zzz.www"). The default value is "0.0.0.0". Note: IP address set as "0.0.0.0" means dynamic IP address assigned during PDP context activation • 8: data compression - the <param_val> parameter refers to the default parameter named <d_comp> and selects the data compression type: <ul style="list-style-type: none"> o 0 (default value): off o 1: predefined, i.e. V.42bis o 2: V.42bis • 9: header compression - the <param_val> parameter refers to the default parameter named <h_comp> and selects the header compression type: <ul style="list-style-type: none"> o 0 (default value): off o 1: predefined, i.e. RFC1144 o 2: RFC1144 o 3: RFC2507 o 4: RFC3095 • 100: map the +UPSD profile to the specified <cid> in the +CGDCONT table. <ul style="list-style-type: none"> o 0: map the current profile to <cid> 0 (where supported) or to the default bearer PDP ID o 1: map the current profile to <cid> 1 o 2: map the current profile to <cid> 2 o 3: map the current profile to <cid> 3 o 4: map the current profile to <cid> 4 o 5: map the current profile to <cid> 5 o 6: map the current profile to <cid> 6 o 7: map the current profile to <cid> 7 o 8: map the current profile to <cid> 8 <p>Allowed values:</p> <ul style="list-style-type: none"> • SARA-R410M-02B / SARA-R410M-63B / SARA-R410M-73B / SARA-R410M-83B / SARA-R412M / SARA-R422 / SARA-R422M8S / SARA-R422S - 0, 100 • SARA-R404M / SARA-R410M-01B / SARA-R410M-52B / SARA-N4 - 0 |

13.5.4 Notes

SARA-R410M-02B / SARA-R410M-63B / SARA-R410M-73B / SARA-R410M-83B / SARA-R412M / SARA-R422 / SARA-R422M8S / SARA-R422S

- If <param_tag>=0 (IP type) only <profile_id>=0 is supported and the <param_val> factory-programmed value is 0 (IPv4).
- If <param_tag>=100 (profile to <cid> mapping) only <profile_id>=0 is supported and the <param_val> factory-programmed value is 0 (map the current profile to default bearer PDP ID).

SARA-R422 / SARA-R422M8S / SARA-R422S

- If the network assigns the control plane Cellular IoT (CloT) EPS optimization to the module, a maximum of two contexts can be activated on the NB-IoT radio access technology. For more details on the CloT EPS optimization and capabilities, see the [+CCIOTOPT](#) and [+UCFGCIOT](#) AT commands.

SARA-R410M-83B

- If the network assigns the control plane Cellular IoT (CloT) EPS optimization to the module, a maximum of two contexts can be activated on the NB-IoT radio access technology. For more details on the CloT EPS optimization, see the [+CCIOTOPT](#) AT command.

SARA-R410M-02B / SARA-R412M

- On SARA-R410M-02B-00, SARA-R410M-02B-01, SARA-R410M-02B-02, SARA-R412M-02B-00, SARA-R412M-02B-01, SARA-R412M-02B-02 the only supported `<param_tag>` is 0 (IP type).

SARA-R404M / SARA-R410M-01B / SARA-R410M-52B / SARA-N4

- If `<param_tag>= 0` (IP type) the `<param_val>` factory-programmed value is 0 (IPv4).

13.6 GPRS attach or detach +CGATT

| +CGATT | | | | | | |
|------------|--------------|--------------|----------------|----------------|---------------|----------------------------|
| Modules | All products | | | | | |
| Attributes | Syntax | PIN required | Settings saved | Can be aborted | Response time | Error reference |
| | full | Yes | No | Yes | Up to 3 min | +CME Error |

13.6.1 Description

Register (attach) the MT to, or deregister (detach) the MT from the GPRS service. After this command the MT remains in AT command mode. If the MT is already in the requested state (attached or detached), the command is ignored and OK result code is returned. If the requested state cannot be reached, an error result code is returned. The command can be aborted if a character is sent to the DCE during the command execution. Any active PDP context will be automatically deactivated when the GPRS registration state changes to detached.



The user should not enter colliding requests (e.g. `AT+CGATT=1` and `AT+CGATT=0`) on different communication ports, because this might cause interoperability issues in case overlapping attach and detach requests are not handled by the network, and could result in an unpredictable registration state. Similarly, when notified of a mobile terminated GPRS detach event (e.g. via `+CGEV URC`), it is recommended to wait a few seconds before entering `AT+CGATT=0` in order to let the pending attach procedure (automatically triggered by the module in most cases) successfully end.



The deregistration action is carried out even if the command is aborted.

13.6.2 Syntax

| Type | Syntax | Response | Example |
|------|---------------------------------------|---|----------------------------------|
| Set | <code>AT+CGATT=[<state>]</code> | OK | <code>AT+CGATT=1</code> OK |
| Read | <code>AT+CGATT?</code> | <code>+CGATT: <state></code> OK | <code>+CGATT: 1</code> OK |
| Test | <code>AT+CGATT=?</code> | <code>+CGATT: (list of supported <state>s)</code> OK | <code>+CGATT: (0-1)</code> OK |

13.6.3 Defined values

| Parameter | Type | Description |
|----------------------------|--------|--|
| <code><state></code> | Number | Indicates the state of GPRS attachment: <ul style="list-style-type: none"> 0: detached 1 (default value): attached |

13.7 PDP context activate or deactivate +CGACT

| +CGACT | | | | | | |
|-------------------|---------------|---------------------|-----------------------|-----------------------|----------------------------|------------------------|
| Modules | All products | | | | | |
| Attributes | Syntax | PIN required | Settings saved | Can be aborted | Response time | Error reference |
| | full | Yes | No | Yes | Up to 40-150 s (see below) | +CME Error |

13.7.1 Description

Activates or deactivates the specified PDP context. After the command, the MT remains in AT command mode. If any context is already in the requested state, the state for the context remains unchanged. If the required action cannot succeed, an error result code is returned. If the MT is not GPRS attached when the activation of a PDP context is required, the MT first performs a GPRS attach and then attempts to activate the specified context.

The maximum expected response time is different whenever the activation or the deactivation of a PDP context is performed (150 s and 40 s respectively).

The deactivation action is carried out even if the command is aborted.

13.7.2 Syntax

| Type | Syntax | Response | Example |
|------|-----------------------------------|---|---------------------|
| Set | AT+CGACT=[<status>[,<cid>[,...]]] | OK | AT+CGACT=1,1 OK |
| Read | AT+CGACT? | [+CGACT: <cid>,<status> [+CGACT: <cid>,<status> [...]]] OK | +CGACT: 1,1 OK |
| Test | AT+CGACT=? | +CGACT: (list of supported <status>s) OK | +CGACT: (0-1) OK |

13.7.3 Defined values

| Parameter | Type | Description |
|-----------|--------|---|
| <status> | Number | Indicates the state of PDP context activation: <ul style="list-style-type: none"> 0: deactivated 1: activated |
| <cid> | Number | See <cid>. |

13.7.4 Notes

SARA-R4 / SARA-N4

- If <cid> is not defined, the command activates or deactivates all the defined PDP contexts.

SARA-R422 / SARA-R422M8S / SARA-R422S

- If the network assigns the control plane Cellular IoT (CloT) EPS optimization to the module, a maximum of two contexts can be activated on the NB-IoT radio access technology. For more details on the CloT EPS optimization and capabilities, see the [+CCIOTOPT](#) and [+UCFGCIOT](#) AT commands.

SARA-R410M-83B

- If the network assigns the control plane Cellular IoT (CloT) EPS optimization to the module, a maximum of two contexts can be activated on the NB-IoT radio access technology. For more details on the CloT EPS optimization, see the [+CCIOTOPT](#) AT command.

13.7.5 Examples

Examples of usage of [+CGDCONT](#), [+CGACT](#), [+CGPADDR](#) command:

| Command sent by the DTE | DCE response | Description |
|-------------------------------------|---|--|
| AT+CMEE=2 | OK | Set the verbose error result codes |
| AT+COPS=0 | OK | |
| AT+COPS? | +COPS: 0,0,"vodafone IT" OK | |
| AT+CGDCONT=1,"IP","web.omnitel.it" | OK | Define several PDP contexts |
| AT+CGDCONT=3,"IP","internet" | OK | |
| AT+CGDCONT=2,"IP","mms.vodafone.it" | OK | |
| AT+CGDCONT? | +CGDCONT: 1,"IP","web.omnitel.it","0.0.0.0",0,0 +CGDCONT: 3,"IP","internet","0.0.0.0",0,0 +CGDCONT: 2,"IP","mms.vodafone.it","0.0.0.0",0,0 OK | Read PDP contexts |
| AT+CGACT=1,1 | OK | Activate the PDP context 1 |
| AT+CGPADDR=1 | +CGPADDR: 1, "91.80.104.82" OK | Show address of the PDP context 1 |
| AT+CGPADDR=2 | +CGPADDR: 2, "0.0.0.0" OK | Show the address of PDP context 2 |
| AT+CGPADDR=3 | +CGPADDR: 3, "0.0.0.0" OK | Show the address of PDP context 3 |
| AT+CGDCONT? | +CGDCONT: 1,"IP","web.omnitel.it","91.80.104.82",0,0 +CGDCONT: 3,"IP","internet","0.0.0.0",0,0 +CGDCONT: 2,"IP","mms.vodafone.it","0.0.0.0",0,0 OK | |
| AT+CGACT=0,1 | OK | Deactivate the PDP context 1 |
| AT+CGDCONT? | +CGDCONT: 1,"IP","web.omnitel.it","0.0.0.0",0,0 +CGDCONT: 3,"IP","internet","0.0.0.0",0,0 +CGDCONT: 2,"IP","mms.vodafone.it","0.0.0.0",0,0 OK | |
| AT+CGACT=1 | OK | Activate all of defined PDP contexts |
| AT+CGDCONT? | +CGDCONT: 1,"IP","web.omnitel.it","91.80.101.207",0,0 +CGDCONT: 3,"IP","internet","83.225.114.136",0,0 +CGDCONT: 2,"IP","mms.vodafone.it","10.159.135.60",0,0 OK | |
| AT+CGPADDR=1 | +CGPADDR: 1, "91.80.101.207" OK | Show the address of PDP context 1 |
| AT+CGPADDR=2 | +CGPADDR: 2, "10.159.135.60" OK | Show the address of PDP context 2 |
| AT+CGACT=0 | OK | Deactivate all of defined PDP contexts |
| AT+CGPADDR=2 | +CGPADDR: 2, "0.0.0.0" OK | Show the address of PDP context 2 |
| AT+CGPADDR=3 | +CGPADDR: 3, "0.0.0.0" OK | Show the address of PDP context 3 |
| AT+CGDCONT? | +CGDCONT: 1,"IP","web.omnitel.it","0.0.0.0",0,0 +CGDCONT: 3,"IP","internet","0.0.0.0",0,0 +CGDCONT: 2,"IP","mms.vodafone.it","0.0.0.0",0,0 OK | |

| Command sent by the DTE | DCE response | Description |
|-------------------------|---|--|
| AT+CGACT=1,2 | OK | Activate the PDP context 2 |
| AT+CGDCONT? | +CGDCONT: 1,"IP","web.omnitel.it","0.0.0.0",0,0 +CGDCONT: 3,"IP","internet","0.0.0.0",0,0 +CGDCONT: 2,"IP","mms.vodafone.it","10.153.123.229",0,0 OK | |
| AT+CGACT=1,3 | OK | Activate PDP context 3 |
| AT+CGDCONT? | +CGDCONT: 1,"IP","web.omnitel.it","0.0.0.0",0,0 +CGDCONT: 3,"IP","internet","83.225.171.77",0,0 +CGDCONT: 2,"IP","mms.vodafone.it","10.153.123.229",0,0 OK | |
| AT+CGACT=1,1 | OK | Activate the PDP context 1 |
| AT+CGDCONT? | +CGDCONT: 1,"IP","web.omnitel.it","91.80.175.163",0,0 +CGDCONT: 3,"IP","internet","83.225.171.77",0,0 +CGDCONT: 2,"IP","mms.vodafone.it","10.153.123.229",0,0 OK | |
| AT+CGACT=0 | OK | Deactivate all of defined PDP contexts |
| AT+CGDCONT? | +CGDCONT: 1,"IP","web.omnitel.it","0.0.0.0",0,0 +CGDCONT: 3,"IP","internet","0.0.0.0",0,0 +CGDCONT: 2,"IP","mms.vodafone.it","0.0.0.0",0,0 OK | |

13.8 Enter PPP state/GPRS dial-up D*

| D* | | | | | | |
|------------|--------------|--------------|----------------|----------------|---------------|-----------------|
| Modules | All products | | | | | |
| Attributes | Syntax | PIN required | Settings saved | Can be aborted | Response time | Error reference |
| | full | Yes | No | No | Up to 3 min | +CME Error |

13.8.1 Description

The V.24 dial command "D", similar to the command with the syntax `AT+CGDATA="PPP",<cid>`, causes the MT to perform the necessary actions to establish the communication between the DTE and the external PDP network through the PPP protocol. This can include performing a PS attach and, if the PPP server on the DTE side starts communication, PDP context activation on the specified PDP context identifier (if not already requested by means of `+CGATT` and `+CGACT` commands).

If the command is accepted and the preliminary PS procedures have succeeded, the "CONNECT" intermediate result code is returned, the MT enters the V.25ter online data state and the PPP L2 protocol between the MT and the DTE is started.



The data session is terminated by one of the following events:

- sending ~+++.
- via a DTR transition from ON to OFF.
- sending an LCP Terminate Request.

13.8.2 Syntax

| Type | Syntax | Response | Example |
|------|--|-----------------------------------|------------------------|
| Set | ATD[<dialing_type_char>]*<dialing_number>[*[<address>][*[<L2P>][*[<cid>]]]]# | CONNECT (data transfer starts) | ATD*99***1# CONNECT |

13.8.3 Defined values

| Parameter | Type | Description |
|---------------------|--------|--|
| <dialing_type_char> | String | Optional (legacy) "T" or "P" character indicating the tone dialing or pulse dialing respectively |
| <dialing_number> | Number | List all the supported values |
| <address> | - | Ignored |
| <L2P> | String | Layer 2 protocol to be used between the DTE and MT; allowed values: <ul style="list-style-type: none"> "PPP" (default value) "M-HEX" "M-RAW_IP" "M-OPT-PPP"  The application on the remote side must support the selected protocol as well. |
| <cid> | Number | See <cid> |

13.8.4 Notes

- Dial-up with PAP/CHAP authentication is not supported on an already active PDP context that was activated without authentication.
- The context identifier <cid> is mapped to 1 if not specified.
- The GPRS dial-up command maps to AT+CGDATA="PPP",<cid>.
- If FDN is enabled and FDN check for PS data call is supported by the module, to perform a GPRS dial-up one of the following entries must be stored in the FDN phonebook: *99#, *99*#, *99**# or *99***#.

SARA-R4 / SARA-N4

- ~+++ is not supported.
- +++ is used to switch to online command mode. The  AT command is used to switch back to data mode.

13.9 Show PDP address +CGPADDR

| +CGPADDR | | | | | | |
|------------|--------------|--------------|----------------|----------------|---------------|----------------------------|
| Modules | All products | | | | | |
| Attributes | Syntax | PIN required | Settings saved | Can be aborted | Response time | Error reference |
| | full | Yes | No | No | - | +CME Error |

13.9.1 Description

Returns a list of PDP addresses for the specified context identifiers. Only defined PDP contexts are displayed. If the <cid> parameter is omitted, the addresses for all defined contexts are returned.

13.9.2 Syntax

| Type | Syntax | Response | Example |
|------|--------------------------------|---|---|
| Set | AT+CGPADDR=[<cid>,<cid> [...]] | +CGPADDR: <cid>,<PDP_addr> [+CGPADDR: <cid>,<PDP_addr> [...]] OK | AT+CGPADDR=1 +CGPADDR: 1,"1.2.3.4" OK |
| Test | AT+CGPADDR=? | +CGPADDR: [(list of defined <cid>s)] OK | +CGPADDR: 1,3 OK |

13.9.3 Defined values

| Parameter | Type | Description |
|------------|--------|--------------------------------------|
| <cid> | Number | See <cid> |
| <PDP_addr> | Number | See <PDP_addr> |

13.10 Packet switched event reporting +CGEREP

| +CGEREP | | | | | | |
|-------------------|---|---------------------|-----------------------|-----------------------|----------------------|------------------------|
| Modules | SARA-R410M-02B SARA-R410M-52B SARA-R410M-63B SARA-R410M-73B SARA-R410M-83B SARA-R412M SARA-R422 SARA-R422M8S SARA-R422S SARA-N4 | | | | | |
| Attributes | Syntax | PIN required | Settings saved | Can be aborted | Response time | Error reference |
| | partial | Yes | No | No | - | +CME Error |

13.10.1 Description

Configures sending of URCs from MT to the DTE, in case of certain events occurring in the packet switched MT or the network. By means of the <mode> parameter, it is possible to control the processing of the URCs codes specified within this command. The <bfr> parameter allows to control the effect on buffered codes when the <mode> parameter is set to 1 (discard URCs when V.24 link is reserved) or 2 (buffer URCs in the MT when link reserved and flush them to the DTE when the link becomes available).

13.10.2 Syntax

| Type | Syntax | Response | Example |
|------|----------------------------|---|----------------------------|
| Set | AT+CGEREP=[<mode>[,<bfr>]] | OK | AT+CGEREP=1,1 OK |
| Read | AT+CGEREP? | +CGEREP: <mode>,<bfr> OK | +CGEREP: 0,0 OK |
| Test | AT+CGEREP=? | +CGEREP: (list of supported <mode>s),(list of supported <bfr>s) OK | +CGEREP: (0-2),(0-1) OK |
| URC | | +CGEV: ME PDN ACT <cid>[,<reason>[,<cid_other>]] +CGEV: ME ACT <p_cid>,<cid>,<event_type> +CGEV: ME PDN DEACT <cid> +CGEV: ME DEACT <PDP_type>,<PDP_addr>,[<cid>] +CGEV: ME DEACT,<p_cid>,<cid>,0 +CGEV: ME DEACT <p_cid>,<cid>,<event_type> +CGEV: ME MODIFY <cid>,<change_reason>,<event_type> +CGEV: ME DETACH +CGEV: ME CLASS <class> +CGEV: NW PDN ACT <cid>[,<reason>] +CGEV: NW ACT <p_cid>,<cid>,<event_type> +CGEV: NW PDN DEACT <cid> +CGEV: NW DEACT <p_cid>,<cid>,0 +CGEV: NW DEACT <p_cid>,<cid>,<event_type> +CGEV: NW DEACT <PDP_type>,<PDP_addr>,[<cid>] +CGEV: NW MODIFY <cid>,<change_reason>,<event_type> +CGEV: NW DETACH +CGEV: NW CLASS <class> +CGEV: VZW_SUBS_ACTION_NORMAL (0) - No restriction to data traffic +CGEV: REJECT <PDP_type>,<PDP_addr> | +CGEV: NW CLASS "CC" |



| Type | Syntax | Response | Example |
|------|--------|--------------------------------------|---------|
| | | +CGEV: NW REACT <PDP_type>, <cid> | |
| | | +CGEV: NW ACT <PDP_type>,<cid> | |

13.10.3 Defined values

| Parameter | Type | Description |
|-----------------|--------|---|
| <mode> | Number | Controls the processing of URCs specified within this command. Allowed values: <ul style="list-style-type: none"> 0 (default value): buffer URCs in the MT; if the buffer is full the oldest ones will be discarded 1: discard URCs when V.24 link is reserved (online); otherwise forward them directly to the DTE 2: buffer URCs in the MT when link reserved (online) and flush them to the DTE when the link becomes available; otherwise forward them directly to the DTE |
| <bfr> | Number | Controls the effect on buffered codes when <mode> 1 or 2 is entered. Allowed values: <ul style="list-style-type: none"> 0 (default value): MT buffer of URCs defined within this command is cleared when <mode> 1 or 2 is entered 1: MT buffer of URCs defined within this command is flushed to the DTE when <mode> 1 or 2 is entered (OK is given before flushing the codes) |
| <cid> | Number | See <cid> |
| <reason> | Number | Indicates whether the reason why the context activation request for PDP type IPv4v6 was not granted: <ul style="list-style-type: none"> 0: IPv4 only allowed 1: IPv6 only allowed 2: single address bearers only allowed 3: single address bearers only allowed and MT initiated context activation for a second address type bearer was not successful |
| <cid_other> | Number | Indicates whether the context identifier allocated by MT for an MT initiated context of a second address type |
| <p_cid> | Number | Numeric parameter that identifies the particular PDP context definition, specified using +CGDCONT, to which a secondary PDP context definition will be associated using +CGDSCONT. This parameter is only locally valid on the interface TE-MT. |
| <event_type> | Number | Indicates whether the event is informational or whether the TE has to acknowledge it: <ul style="list-style-type: none"> 0: informational event 1: information request: acknowledgement required |
| <change_reason> | Number | Indicates what kind of change occurred: <ul style="list-style-type: none"> 1: TFT only changed 2: QoS only changed 3: both TFT and QoS changed |
| <PDP_type> | Number | See <PDP_type> |
| <PDP_addr> | Number | See <PDP_addr> |
| <class> | String | GPRS mobile class. Allowed values: <ul style="list-style-type: none"> "A": class A mode of operation (A/Gb mode), or CS/PS mode of operation (lu mode) (highest mode of operation) "B": class B (circuit-switched and packet-switched data alternatively supported) "CG": class C (one service only) in GPRS mode "CC": class C (one service only) in circuit-switched (GSM) mode |

13.10.4 Explanation of URCs

| URC | Remarks |
|--|---|
| +CGEV: ME PDN ACT <cid>[,<reason>[,<cid_other>]] | The MT has activated a primary context. |
| +CGEV: ME ACT <p_cid>,<cid>,<event_type> | The network has responded to a MT initiated secondary context activation. |
| +CGEV: ME PDN DEACT <cid> | The MT has forced a primary context deactivation. |
| +CGEV: ME DEACT <PDP_type>,<PDP_addr>[,<cid>] | The MT has forced a context deactivation. |
| +CGEV: ME DEACT,<p_cid>,<cid>,0 | The UE has forced a secondary context deactivation. |
| +CGEV: ME DEACT <p_cid>,<cid>,<event_type> | The MT has forced a secondary context deactivation. |

| URC | Remarks |
|--|---|
| +CGEV: ME MODIFY <cid>,<change_reason>,<event_type> | The MT has forced a context modification. |
| +CGEV: ME DETACH | The mobile station has forced a GPRS detach |
| +CGEV: ME CLASS <class> | The mobile station has forced a change of MT class; the highest available class is reported. |
| +CGEV: NW PDN ACT <cid>[,<reason>] | The network has activated a primary context. |
| +CGEV: NW ACT <p_cid>,<cid>,<event_type> | The network has forced a secondary context activation. |
| +CGEV: NW PDN DEACT <cid> | The network has forced a primary context deactivation. |
| +CGEV: NW DEACT <p_cid>,<cid>,0 | The network has forced a secondary context deactivation. |
| +CGEV: NW DEACT <p_cid>,<cid>,<event_type> | The network has forced a secondary context deactivation. |
| +CGEV: NW DEACT <PDP_type>,<PDP_addr>,[<cid>] | The network has forced a context deactivation. |
| +CGEV: NW MODIFY <cid>,<change_reason>,<event_type> | The network has forced a context modification. |
| +CGEV: NW DETACH | The network has forced a GPRS detach |
| +CGEV: NW CLASS <class> | The network has forced a change of MT class (e.g. due to service detach); the highest available class is reported. |
| +CGEV: VZW_SUBS_ACTION_NORMAL (0) - No restriction to data traffic | No restriction to data traffic. The URC is provided only on Verizon network. |
| +CGEV: REJECT <PDP_type>,<PDP_addr> | The context activation is rejected.  SARA-R4 / SARA-N4 Not supported. |
| +CGEV: NW REACT <PDP_type>,<cid> | The network has forced a context re-activation.  SARA-R4 / SARA-N4 Not supported. |
| +CGEV: NW ACT <PDP_type>,<cid> | The network has forced a context activation.  SARA-R4 / SARA-N4 Not supported. |

13.11 GPRS network registration status +CGREG

| +CGREG | | | | | | |
|-------------------|---|---------------------|-----------------------|-----------------------|----------------------|------------------------|
| Modules | SARA-R410M-02B SARA-R410M-52B SARA-R410M-63B SARA-R410M-73B SARA-R410M-83B SARA-R412M SARA-R422 SARA-R422M8S SARA-R422S SARA-N4 | | | | | |
| Attributes | Syntax | PIN required | Settings saved | Can be aborted | Response time | Error reference |
| | partial | Yes | No | No | - | +CME Error |

13.11.1 Description

Configures the GPRS network registration information. Depending on the <n> parameter value, a URC can be issued:

- +CGREG: <stat> if <n>=1 and there is a change in the GPRS network registration status in GERAN/UTRAN
- +CGREG: <stat>[,<lac>,<ci>[,<AcT>,<rac>]] if <n>=2 and there is a change of the network cell in GERAN/UTRAN

The parameters <lac>, <ci>, <AcT>, <rac> are provided only if available.

The read command provides the same information issued by the URC together with the current value of the <n> parameter. The location information elements <lac>, <ci> and <AcT>, if available, are returned only when <n>=2 and the MT is registered with the network.

 When <n>=2, in UMTS RAT, unsolicited location information can be received if the network sends the UTRAN INFORMATION MOBILITY message during dedicated connections; in the latter cases the reported <ci> might be not correct because the UE in DCH state cannot read broadcast system information before the change of serving cell. In contrast, in GSM RAT no unsolicited location information is received during a CS connection.

 If the GPRS MT also supports circuit mode services in GERAN/UTRAN and/or EPS services in E-UTRAN, the +CREG / +CEREG commands return the registration status and location information for those services.

13.11.2 Syntax

| Type | Syntax | Response | Example |
|------|----------------|--|---|
| Set | AT+CGREG=[<n>] | OK | AT+CGREG=1 OK |
| Read | AT+CGREG? | If <n>=0 or 1: +CGREG: <n>,<stat> OK If <n>=2: +CGREG: <n>,<stat>[,<lac>,<ci>[,<AcT>,<rac>]] OK | +CGREG: 0,4 OK +CGREG: 2,1,"61EF","7D58A3",2,"14" OK |
| Test | AT+CGREG=? | +CGREG: (list of supported <n>s) OK | +CGREG: (0-2) OK |
| URC | | If <n>=1: +CGREG: <stat> If <n>=2: +CGREG: <stat>[,<lac>,<ci>[,<AcT>,<rac>]] | +CGREG: 1 +CGREG: 1,"4E54","44A5" |

13.11.3 Defined values

| Parameter | Type | Description |
|-----------|--------|---|
| <n> | Number | <ul style="list-style-type: none"> 0 (default value and factory-programmed value): network registration URC disabled 1: network registration URC enabled 2: network registration and location information URC enabled |
| <stat> | Number | <ul style="list-style-type: none"> 0: not registered, the MT is not currently searching an operator to register to 1: registered, home network 2: not registered, but MT is currently searching a new operator to register to 3: registration denied 4: unknown (e.g. out of GERAN/UTRAN coverage) 5: registered, roaming 8: attached for emergency bearer services only (see 3GPP TS 24.008 [67] and 3GPP TS 24.301 [102] that specify the condition when the MS is considered as attached for emergency bearer services) (applicable only when <AcT> indicates 2,4,5,6) |
| <lac> | String | Two bytes location area in hexadecimal format; it is optionally provided in the URC and in the response to the read command if <n>=2. The value FFFF means that the current <lac> value is invalid. |
| <ci> | String | From 2 to 4 bytes cell ID in hexadecimal format; it is optionally provided in the URC and in the response to the read command if <n>=2. The value FFFFFFFF means that the current <ci> value is invalid. |
| <AcT> | Number | Indicates the radio access technology: <ul style="list-style-type: none"> 0: GSM 1: GSM COMPACT 2: UTRAN 3: GSM/GPRS with EDGE availability 4: UTRAN with HSDPA availability 5: UTRAN with HSUPA availability 6: UTRAN with HSDPA and HSUPA availability 7: E-UTRAN 8: EC-GSM-IoT (A/Gb mode) 9: E-UTRAN (NB-S1 mode) 255: the current <AcT> value is invalid Allowed values: <ul style="list-style-type: none"> SARA-R412M / SARA-R422 / SARA-R422M8S / SARA-R422S - 0, 3, 7, 9 SARA-R410M-02B / SARA-R410M-52B / SARA-R410M-83B - 7, 9 SARA-R410M-01B - 8 SARA-R404M / SARA-R410M-63B / SARA-R410M-73B - 7 |

| Parameter | Type | Description |
|-----------|--------|---|
| | | <ul style="list-style-type: none"> SARA-N4 - 9 |
| <rac> | String | One byte routing area in hexadecimal format |

13.11.4 Notes

- The DTE application should set a reasonable timer (10 s) when receiving the +CGREG: 3 URC, since this might be due to the fact that the LTE registration was rejected (SIM not enabled for LTE RAT, wrong APN during the initial default bearer set-up in the EPS attach procedure and other temporary reject causes).
- If the device does not support 2G or 3G RAT, the command will report only <stat>=0, 2 and 4.

SARA-R4 / SARA-N4

- <stat>=8 is not supported.

SARA-R410M-01B

- <AcT>=8 is used for E-UTRAN (<AcT>=7).

13.12 Manual deactivation of a PDP context H

| H | | | | | | |
|------------|-----------------------------------|--------------|----------------|----------------|---------------|-----------------|
| Modules | SARA-R422 SARA-R422M8S SARA-R422S | | | | | |
| Attributes | Syntax | PIN required | Settings saved | Can be aborted | Response time | Error reference |
| | full | No | No | No | < 20 s | +CME Error |

13.12.1 Description

Deactivates an active PDP context with PPP L2 protocol in online command mode. The MT responds with a final result code. For a detailed description, see the [H](#) command description. For additional information about OLCM, see the [AT command settings](#).



In GPRS online command mode, entered by typing the escape sequence "+++" or "~+++" (see [&D](#)), the ATH command is needed to terminate the connection. Alternatively, in data transfer mode, DTE originated DTR toggling or PPP disconnection may be used.

13.12.2 Syntax

| Type | Syntax | Response | Example |
|--------|--------|----------|---------|
| Action | ATH | OK | |

13.13 UE modes of operation for EPS +CEMODE

| +CEMODE | | | | | | |
|------------|---|--------------|----------------|----------------|---------------|-----------------|
| Modules | SARA-R410M-02B SARA-R410M-52B SARA-R410M-63B SARA-R410M-73B SARA-R410M-83B SARA-R412M SARA-R422 SARA-R422M8S SARA-R422S SARA-N4 | | | | | |
| Attributes | Syntax | PIN required | Settings saved | Can be aborted | Response time | Error reference |
| | full | Yes | NVM / OP | No | - | +CME Error |

13.13.1 Description

Sets the MT to operate according to the specified mode of operation for EPS, see 3GPP TS 24.301 [102]. If the requested operation mode is not supported, an error result code is returned.



SARA-R410M-02B / SARA-R410M-52B / SARA-R410M-63B / SARA-R410M-73B / SARA-R410M-83B / SARA-R412M / SARA-R422 / SARA-R422M8S / SARA-R422S
The set command is not supported, use the [+USVCDOMAIN](#) AT command to configure the service domain (CS/PS) upon network attach. The operation mode for EPS is network operator specific and handled via the [+UMNPROF](#) command.



SARA-N4
The set command is not supported. The operation mode for EPS is network operator specific and handled via the [+UMNPROF](#) command.



u-blox cellular modules are certified according to all the capabilities and options stated in the Protocol Implementation Conformance Statement document (PICS) of the module. The PICS, according to 3GPP TS 51.010-2 [100], 3GPP TS 34.121-2 [101], 3GPP TS 36.521-2 [122] and 3GPP TS 36.523-2 [123], is a statement of the implemented and supported capabilities and options of a device. If the user changes the command settings during the certification process, the PICS of the application device integrating a u-blox cellular module must be changed accordingly.

13.13.2 Syntax

| Type | Syntax | Response | Example |
|------|--------------------|---|----------------------|
| Set | AT+CEMODE=[<mode>] | OK | AT+CEMODE=1 OK |
| Read | AT+CEMODE? | +CEMODE: <mode> OK | +CEMODE: 1 OK |
| Test | AT+CEMODE=? | +CEMODE: (list of supported <mode>'s) OK | +CEMODE: (0-3) OK |

13.13.3 Defined values

| Parameter | Type | Description |
|-----------|--------|--|
| <mode> | Number | Mode configuration: <ul style="list-style-type: none"> 0: PS mode 2 of operation. The UE registers only to EPS services, and the UE's usage setting is "data centric" 1 (default and factory-programmed value for voice capable devices): CS/PS mode 1 of operation. The UE registers to both EPS and non-EPS services, and the UE's usage setting is "voice centric" 2 (default and factory-programmed value for voice not-capable devices): CS/PS mode 2 of operation. The UE registers to both EPS and non-EPS services, and the UE's usage setting is "data centric" 3: PS mode 1 of operation. The UE registers only to EPS services, and the UE's usage setting is "voice centric" |

13.13.4 Notes

- A UE set to "Data centric" does not disable the E-UTRAN capability if voice services cannot be obtained. Upon receiving combined EPS/IMSI attach accept or combined TA/LA Update accept with "SMS-only" indication, a data centric UE stays in the current RAT and is not allowed to use CSFB. Upon receiving combined EPS/IMSI attach accept or combined TA/LA Update accept with "CSFB Not Preferred" indication, a data centric UE stays in the current RAT and is allowed to use CSFB.
- A UE set to "Voice centric" shall always try to ensure that Voice service is possible. A CSFB and an IMS/CS-voice capable UE set to "Voice centric" unable to obtain voice service in E-UTRAN (e.g. CSFB and IMS voice are not supported or the configured preferences on how to handle voice services prevent usage of any available voice services), shall disable the E-UTRAN capability, which results in re-selecting GERAN or UTRAN. The E-UTRAN capability is re-enabled by the UE under the conditions described in 3GPP TS 24.301 [102].

13.14 EPS network registration status +CEREG

| +CEREG | | | | | | |
|------------|--------------|--------------|----------------|----------------|---------------|-----------------|
| Modules | All products | | | | | |
| Attributes | Syntax | PIN required | Settings saved | Can be aborted | Response time | Error reference |
| | full | No | No | No | - | +CME Error |

13.14.1 Description

Configures the network registration URC related to EPS domain. The URC assumes a different syntax depending on the network and the <n> parameter:

- +CEREG: <stat> when <n>=1 and there is a change in the MT's EPS network registration status in E-UTRAN
- +CEREG: <stat>[, [<tac>], [<ci>], [<Act>]] when <n>=2 and there is a change of the network cell in EUTRAN

- +CEREG: <stat>[,<tac>],[<ci>],[<AcT>],[<cause_type>,<reject_cause>]] when <n>=3 and the value of <stat> changes
- +CEREG: <stat>[,<tac>],[<ci>],[<AcT>][,],[<Assigned_Active_Time>,[<Assigned_Periodic_TAU>]]]]]] when <n>=4 if there is a change of the network cell in E-UTRAN
- +CEREG: <stat>[,<tac>],[<ci>],[<AcT>][,<cause_type>],[<reject_cause>][,<Assigned_Active_Time>,[<Assigned_Periodic_TAU>]]]]]] when <n>=5 and the value of <stat> changes



SARA-R410M-02B / SARA-R410M-52B / SARA-R412M

When <n>=4 if there is a change of the network cell in E-UTRAN, the +URC assumes the following syntax:

- +CEREG: <stat>[,<tac>],[<rac_or_mme>],[<ci>],[<AcT>][,],[<Assigned_Active_Time>,[<Assigned_Periodic_TAU>]]]]]]

The parameters <AcT>, <tac>, <rac_or_mme>, <ci>, <cause_type>, <reject_cause>, <Assigned_Active_Time> and <Assigned_Periodic_TAU> are provided only if available.

The read command returns always at least the mode configuration (<n>), the EPS registration status (<stat>). The location parameters <tac>, <rac_or_mme>, <ci> and <AcT>, if available, are returned only when <n>=2, <n>=3, <n>=4 or <n>=5 and the MT is registered with the network. The parameters <cause_type>, <reject_cause>, if available, are returned when <n>=3 or <n>=5. The PSM related parameter <Assigned_Active_Time> is returned only when <n>=4 or <n>=5, the MT is registered with the network and PSM is granted by the network. The <Assigned_Periodic_TAU> parameter is returned only if when <n>=4 or <n>=5, the MT is registered with the network, PSM is granted by the network and an extended periodic TAU value (T3412_ext) is assigned.



SARA-R4 / SARA-N4

If the EPS MT in GERAN/UTRAN/E-UTRAN also supports circuit mode services and/or GPRS services, the +CREG / +CGREG set and read command result codes apply to the registration status and location information for those services.

13.14.2 SARA-R404M / SARA-R410M-01B / SARA-R410M-63B / SARA-R410M-73B / SARA-R410M-83B / SARA-R422 / SARA-R422M8S / SARA-R422S / SARA-N4 Syntax

| Type | Syntax | Response | Example |
|------|---------------|--|---------------------------------------|
| Set | AT+CEREG=<n>] | OK | AT+CEREG=1 OK |
| Read | AT+CEREG? | +CEREG: <n>,<stat>[,<tac>],[<ci>],[<AcT>][,<cause_type>],[<reject_cause>][,<Assigned_Active_Time>,[<Assigned_Periodic_TAU>]]]]]] OK | +CEREG: 2,1,"3a9b","0000c33d",7 OK |
| Test | AT+CEREG=? | +CEREG: (list of supported <n>s) OK | +CEREG: (0-3) OK |
| URC | | +CEREG: <stat>[,<tac>],[<ci>],[<AcT>][,<cause_type>],[<reject_cause>][,<Assigned_Active_Time>,[<Assigned_Periodic_TAU>]]]]]] | +CEREG: 1,"3a9b","0000c33d",7 |

13.14.3 SARA-R410M-02B / SARA-R410M-52B / SARA-R412M Syntax

| Type | Syntax | Response | Example |
|------|---------------|---|---------------------------------------|
| Set | AT+CEREG=<n>] | OK | AT+CEREG=1 OK |
| Read | AT+CEREG? | +CEREG: <n>,<stat>[,<tac>],[<rac_or_mme>],[<ci>],[<AcT>][,<cause_type>],[<reject_cause>][,<Assigned_Active_Time>,[<Assigned_Periodic_TAU>]]]]]] OK | +CEREG: 2,1,"3a9b","0000c33d",7 OK |
| Test | AT+CEREG=? | +CEREG: (list of supported <n>s) | +CEREG: (0-3) |

| Type | Syntax | Response | Example |
|------|--------|---|-------------------------------|
| | | OK | OK |
| URC | | +CEREG: <stat>[,<tac>],[<rac_or_mme>],[<ci>],[<AcT>],[<cause_type>],[<reject_cause>][,<Assigned_Active_Time>,[<Assigned_Periodic_TAU>]]]] | +CEREG: 1,"3a9b","0000c33d",7 |

13.14.4 Defined values

| Parameter | Type | Description |
|--------------|--------|---|
| <n> | Number | <p>Mode configuration:</p> <ul style="list-style-type: none"> 0: network registration URC disabled 1: network registration URC +CEREG: <stat> enabled 2: network registration and location information URC +CEREG: <stat>[,<tac>],[<ci>],[<AcT>]] enabled 3: network registration, location information and EMM cause value information URC +CEREG: <stat>[,<tac>],[<ci>],[<AcT>],[<cause_type>,<reject_cause>]] enabled 4: PSM, network registration and location information information URC +CEREG: <stat>[,<tac>],[<ci>],[<AcT>][,<Assigned_Active_Time>,[<Assigned_Periodic_TAU>]]]] enabled 5: PSM, network registration, location information and EMM cause value information URC +CEREG: <stat>[,<tac>],[<ci>],[<AcT>][,<cause_type>],[<reject_cause>][,<Assigned_Active_Time>,[<Assigned_Periodic_TAU>]]]] enabled <p>Allowed values:</p> <ul style="list-style-type: none"> SARA-R404M / SARA-R410M-01B / SARA-N4 - 0 (default value), 1, 2, 3 SARA-R410M-02B / SARA-R410M-52B / SARA-R410M-63B / SARA-R410M-73B / SARA-R410M-83B / SARA-R412M / SARA-R422 / SARA-R422M8S / SARA-R422S - 0 (default value), 1, 2, 3, 4 <p> SARA-R410M-02B On SARA-R410M-02B-00 allowed values are: 0 (default value), 1, 2, 3.</p> |
| <stat> | Number | <p>EPS registration status:</p> <ul style="list-style-type: none"> 0: not registered 1: registered, home network 2: not registered, but the MT is currently trying to attach or searching an operator to register to 3: registration denied 4: unknown (e.g. out of E-UTRAN coverage) 5: registered, roaming 8: attached for emergency bearer services only (see 3GPP TS 24.008 [67] and 3GPP TS 24.301 [102] that specify the condition when the MS is considered as attached for emergency bearer services) |
| <tac> | String | Two bytes tracking area code in hexadecimal format |
| <ci> | String | Four bytes E-UTRAN cell-id in hexadecimal format |
| <AcT> | Number | <p>Access technology of the serving cell:</p> <ul style="list-style-type: none"> 0: GSM 3: GSM/GPRS with EDGE availability 7: E-UTRAN (see 3GPP TS 44.060 [103] that specifies the System Information messages which give the information about whether the serving cell supports EGPRS) 8: E-UTRAN EC-GSM-IoT (A/Gb mode) 9: E-UTRAN NB-IoT <p>Allowed values:</p> <ul style="list-style-type: none"> SARA-R412M / SARA-R422 / SARA-R422M8S / SARA-R422S - 0, 3, 7, 9 SARA-R410M-01B - 8, 9 SARA-R410M-02B / SARA-R410M-52B / SARA-R410M-83B - 7, 9 SARA-R404M / SARA-R410M-63B / SARA-R410M-73B - 7 SARA-N4 - 9 |
| <cause_type> | Number | <reject_cause> type: |

| Parameter | Type | Description |
|-------------------------|--------|--|
| | | <ul style="list-style-type: none"> 0: indicates that <reject_cause> contains an EMM cause value, see 3GPP TS 24.301 [102] Annex A 1: indicates that <reject_cause> contains a manufacture-specific cause Allowed values: <ul style="list-style-type: none"> SARA-R4 / SARA-N4 - 0 |
| <reject_cause> | Number | Cause of the failed registration. The value is of type as defined by <cause_type> |
| <Assigned_Active_Time> | String | One byte in an 8 bit format. Assigned Active Time value (T3324) allocated to the UE. The assigned Active Time value is coded as one byte (octet 3) of the GPRS Timer 2 information element coded as bit format (e.g. "00100100" equals 4 minutes). For the coding and the value range, see the GPRS Timer 2 IE in 3GPP TS 24.008 table 10.5.163/3GPP TS 24.008 [67]. See also 3GPP TS 23.682 [142], 3GPP TS 23.060 [65] and 3GPP TS 23.401 [143]. |
| <Assigned_Periodic_TAU> | String | One byte in an 8 bit format. Assigned extended periodic TAU value (T3412_ext) allocated to the UE. The assigned extended periodic TAU value is coded as one byte (octet 3) of the GPRS Timer 3 information element coded as bit format (e.g. "01000111" equals 70 hours). For the coding and the value range, see the GPRS Timer 2 IE in 3GPP TS 24.008 table 10.5.163a/3GPP TS 24.008 [67]. See also 3GPP TS 23.682 [142] and 3GPP TS 23.401 [143]. |
| <rac_or_mme> | String | RAC (Routing Area Code) or MME Code (Mobile Management Entity) in hexadecimal format |

13.14.5 Notes

SARA-R4 / SARA-N4

- <stat>=8 is not supported.
- The parameter <stat> assumes value 6 after module boot or when the module exits Power Saving Mode (PSM).
- <tac>, <ci> and <AcT> should be ignored when the module is not registered.
- If <stat>=0 and while in full cellular functionality (+CFUN: 1), the MT is not registered and it performs a network scan through all enabled Radio Access Technologies (RATs). The MT does not stop searching until it can find a network operator to register to.

SARA-R410M-01B

- <AcT>=8 reports LTE Cat M1.

13.15 Delete non-active PDP contexts +CGDEL

| +CGDEL | | | | | | |
|------------|--------------|--------------|----------------|----------------|---------------|-----------------|
| Modules | All products | | | | | |
| Attributes | Syntax | PIN required | Settings saved | Can be aborted | Response time | Error reference |
| | full | No | No | No | - | +CME Error |

13.15.1 Description

Removes the indicated PDP context and removes all the associated data related to the indicated PDP contexts that are not activated. The AT command does not delete or remove the information for activated PDP contexts. The removed PDP context is listed by the <+CGDEL: cid> IRC.

If the <cid> parameter points to a primary PDP context, the PDP context will be deleted together with all the linked secondary PDP contexts if none of the PDP contexts are activated.

If the <cid> parameter points to a secondary PDP context, the PDP context will be deleted if it is not activated.



If the parameter <cid> is omitted, all the primary PDP contexts that are not activated or that have any activated secondary PDP contexts will be removed and all secondary PDP contexts that are not activated will be removed. The associated data of all the deleted PDP contexts will be removed, and the removed PDP context are listed by the +CGDEL: <cid>[,<cid>,...]] IRC.



SARA-R4 / SARA-N4

The command removes the associated PDP context data that can be set by the AT command +CGDCONT. For an attempt to delete PDP context(s) which would violate these rules, an error result code is returned.

13.15.2 Syntax

| Type | Syntax | Response | Example |
|------|------------------|-----------------------------------|-------------------------------|
| Set | AT+CGDEL=[<cid>] | +CGDEL: <cid>[,<cid>[,...]] OK | AT+CGDEL=2 +CGDEL: 2 OK |
| Test | AT+CGDEL=? | OK | OK |

13.15.3 Defined values

| Parameter | Type | Description |
|-----------|--------|-------------|
| <cid> | Number | See <cid> |

13.16 Configure the authentication parameters of a PDP/EPS bearer +UAUTHREQ

| +UAUTHREQ | | | | | | |
|-------------------|---|---------------------|-----------------------|-----------------------|----------------------|------------------------|
| Modules | SARA-R410M-02B SARA-R410M-52B SARA-R410M-63B SARA-R410M-73B SARA-R410M-83B SARA-R412M SARA-R422 SARA-R422M8S SARA-R422S SARA-N4 | | | | | |
| Attributes | Syntax | PIN required | Settings saved | Can be aborted | Response time | Error reference |
| | partial | Yes | NVM | No | - | +CME Error |

13.16.1 Description

Configures the authentication parameters of a defined PDP/EPS bearer. The authentication parameters will be sent during the context activation phase as a protocol configuration options (PCO) information element.



SARA-R4 / SARA-N4

The command returns an error result code if the input <cid> is already active or not yet defined.

13.16.2 Syntax

| Type | Syntax | Response | Example |
|------|---|---|-------------------------------------|
| Set | AT+UAUTHREQ=<cid>,<auth_type>,<username>,<password> | OK | AT+UAUTHREQ=1,1,"user","pass" OK |
| Test | AT+UAUTHREQ=? | +UAUTHREQ: (list of supported <cid>s),(list of supported <auth_type>s)[,.,] OK | +UAUTHREQ: (1-8),(0-2),, OK |

13.16.3 Defined values

| Parameter | Type | Description |
|-------------|--------|--|
| <cid> | Number | See <cid>. |
| <auth_type> | Number | Configure the authentication: <ul style="list-style-type: none"> 0: no authentication 1: PAP 2: CHAP 3: automatic selection of authentication type (none/CHAP/PAP) Allowed values: <ul style="list-style-type: none"> SARA-R4 / SARA-N4 - 0, 1, 2 |
| <username> | String | Username. The default value is an empty string: <ul style="list-style-type: none"> SARA-R422 / SARA-R422M8S / SARA-R422S - The maximum length is 127. SARA-R410M / SARA-R412M / SARA-N4 - The maximum length is 64. |
| <password> | String | Password. The default value is an empty string: <ul style="list-style-type: none"> SARA-R422 / SARA-R422M8S / SARA-R422S - The maximum length is 127. SARA-R410M / SARA-R412M / SARA-N4 - The maximum length is 64. |

13.16.4 Notes

- In a PPP dial-up scenario, the authentication parameters set by the +UAUTHREQ command are overwritten whenever the host provides a new setting via the PPP authentication protocol (PAP or CHAP).

SARA-R4 / SARA-N4

- The <username> and <password> parameters must be omitted if the authentication type is not set (<auth_type>=0).
- If <auth_type>=1 or 2, then the set command syntax is AT+UAUTHREQ=<cid>,<auth_type>,<password>,<username>.

13.17 PDP context read dynamic parameters +CGCONTRDP

| +CGCONTRDP | | | | | | |
|-------------------|---|---------------------|-----------------------|-----------------------|----------------------|------------------------|
| Modules | SARA-R410M-02B SARA-R410M-52B SARA-R410M-63B SARA-R410M-73B SARA-R410M-83B SARA-R412M SARA-R422 SARA-R422M8S SARA-R422S SARA-N4 | | | | | |
| Attributes | Syntax | PIN required | Settings saved | Can be aborted | Response time | Error reference |
| | partial | No | No | No | - | +CME Error |

13.17.1 Description

Returns the relevant information <bearer_id>, <APN>, <local_addr_and_subnet_mask>, <gw_addr>, <DNS_prim_addr>, <DNS_sec_addr>, <P-CSCF_prim_addr>, <P-CSCF_sec_addr>, <IM_CN_Signalling_Flag_Ind>, <LIPA_indication>, <IPv4_MTU> and <WLAN_offload> for an active non secondary PDP context with the context identifier <cid>.

If the MT indicates more than two IP addresses of P-CSCF servers or more than two IP addresses of DNS servers, multiple lines of information per <cid> will be returned.

A set command with an undefined <cid> provides an error result code.

If the parameter <cid> is omitted, the relevant information for all active non secondary PDP contexts is returned.

SARA-R4 / SARA-N4

If the <pdp_type> parameter is set to "IPV4V6", for each IP address both the IPv4 and the IPv6 addresses are printed. The printing format depends on the parameter:

- <local_addr_and_subnet_mask>, <P-CSCF_prim_addr>, <P-CSCF_sec_addr>: the IPv4 address and the IPv6 addresses are separated by a comma (<IPv4>,<IPv6>).
- <gw_addr>, <DNS_prim_addr>, <DNS_sec_addr>: the IPv4 address and the IPv6 addresses are separated by a space (<IPv4> <IPv6>).

The command is not effective if the <PDP_type>="NONIP".

SARA-R4 / SARA-N4

The IPv6 addresses notation depends on the +CGPIAF setting.

13.17.2 Syntax

| Type | Syntax | Response | Example |
|------|----------------------|---|---|
| Set | AT+CGCONTRDP[=<cid>] | [+CGCONTRDP: <cid>,<bearer_id>,<APN>[,<local_addr_and_subnet_mask>[,<gw_addr>[,<DNS_prim_addr>[,<DNS_sec_addr>[,<P-CSCF_prim_addr>[,<P-CSCF_sec_addr>[,<IM_CN_Signalling_Flag_Ind>[,<LIPA_indication>[,<IPv4_MTU>[,<WLAN_offload>[,<Local_Addr_Ind>[,<Non_IP_MTU>[,<Serving_PLMN_rate_control_value>]]]]]]]]]]]] [+CGCONTRDP: <cid>,<bearer_id>,<APN>[,<local_addr_and_subnet_ | AT+CGCONTRDP=1 +CGCONTRDP: 1,0,"web.omnitel.it", "109.113.62.238.255.255.255.255", "109.113.62.201", "83.224.70.77", "83.224.70.54",,,0,0,0 OK |

| Type | Syntax | Response | Example |
|------|----------------|--|---------------------|
| | | mask> [,<gw_addr>[,<DNS_prim_addr>[,<DNS_sec_addr>[,<P-CSCF_prim_addr>[,<P-CSCF_sec_addr>[,<IM_CN_Signalling_Flag_Ind>[,<LIPA_indication>[,<IPv4_MTU>[,<WLAN_offload>[,<Local_Addr_Ind>[,<Non_IP_MTU>[,<Serving_PLMN_rate_control_value>]]]]]]]]]]]]] [...] | |
| Test | AT+CGCONTRDP=? | OK +CGCONTRDP: (list of active non secondary PDP contexts) OK | +CGCONTRDP: 1 OK |

13.17.3 Defined values

| Parameter | Type | Description |
|------------------------------|--------|---|
| <cid> | Number | See <cid>. |
| <APN> | String | See <APN>. |
| <bearer_id> | Number | Identifies the bearer, i.e. the EPS bearer in EPS and the NSAPI in UMTS/GPRS. The range goes from 5 to 16. |
| <local_addr_and_subnet_mask> | String | IP address and subnet mask of the MT. The string is given as dot-separated numeric (0-255) parameters on the form: <ul style="list-style-type: none"> "a1.a2.a3.a4.m1.m2.m3.m4" for IPv4 "a1.a2.a3.a4.a5.a6.a7.a8.a9.a10.a11.a12.a13.a14.a15.a16.m1.m2.m3.m4.m5.m6.m7.m8.m9.m10.m11.m12.m13.m14.m15.m16" for IPv6 |
| <gw_addr> | String | Gateway address of the MT. The string is given as dot-separated numeric (0-255) parameters. |
| <DNS_prim_addr> | String | IP address of the primary DNS server. |
| <DNS_sec_addr> | String | IP address of the secondary DNS server. |
| <P-CSCF_prim_addr> | String | IP address of the primary P-CSCF server. |
| <P-CSCF_sec_addr> | String | IP address of the secondary P-CSCF server. |
| <IM_CN_Signalling_Flag_Ind> | Number | Shows whether the PDP context is for IM CN subsystem-related signalling only or not: <ul style="list-style-type: none"> 0: PDP context is not for IM CN subsystem-related signalling only 1: PDP context is for IM CN subsystem-related signalling only |
| <LIPA_indication> | Number | Indicates that the PDP context provides connectivity using a LIPA PDN connection. This parameter cannot be set by the TE: <ul style="list-style-type: none"> 0: indication not received that the PDP context provides connectivity using a LIPA PDN connection 1: indication received that the PDP context provides connectivity using a LIPA PDN connection |
| <IPv4_MTU> | Number | Provides the IPv4 MTU size in octets. |
| <WLAN_offload> | Number | Indicates whether the traffic can be offloaded using the specified PDN connection via a WLAN or not. This refers to bits 1 and 2 of the WLAN offload acceptability IE as specified in 3GPP TS 24.008 [67] subclause 10.5.6.20. Allowed values: <ul style="list-style-type: none"> 0: offloading the traffic of the PDN connection via a WLAN when in S1 mode or when in lu mode is not acceptable 1: offloading the traffic of the PDN connection via a WLAN when in S1 mode is acceptable, but not acceptable in lu mode 2: offloading the traffic of the PDN connection via a WLAN when in lu mode is acceptable, but not acceptable in S1 mode 3: offloading the traffic of the PDN connection via a WLAN when in S1 mode or when in lu mode is acceptable |
| <Local_Addr_Ind> | Number | Indicates whether or not the MS and the network support local IP address in TFTs (see 3GPP TS 24.301 [102] and 3GPP TS 24.008 [67] subclause 10.5.6.3). Allowed values: <ul style="list-style-type: none"> 0: indicates that the MS or the network or both do not support local IP address in TFTs |

| Parameter | Type | Description |
|-----------------------------------|--------|--|
| <Non_IP_MTU> | Number | Non-IP MTU size in octets. |
| <Serving_PLMN_rate_control_value> | Number | Indicates the maximum number of uplink messages the UE is allowed to send in a 6 minutes interval. This refers to octet 3 to 4 of the Serving PLMN rate control IE as specified in 3GPP TS 24.301 [102]. |

13.17.4 Notes

SARA-R4 / SARA-N4

- The <IM_CN_Signalling_Flag_Ind>, <LIPA_indication>, <IPv4_MTU>, <WLAN_offload>, <Local_Addr_Ind>, <Non_IP_MTU> and <Serving_PLMN_rate_control_value> parameters are not supported.
- The <local_addr_and_subnet_mask> do not include the MT subnet mask.

13.18 Initial PDP context activation +CIPCA

| +CIPCA | | | | | | |
|------------|----------------|----------------|----------------|----------------|---------------|-----------------|
| Modules | SARA-R410M-63B | SARA-R410M-73B | SARA-R410M-83B | SARA-R422 | SARA-R422M8S | SARA-R422S |
| Attributes | Syntax | PIN required | Settings saved | Can be aborted | Response time | Error reference |
| | full | No | NVM | No | - | +CME Error |

13.18.1 Description

Controls whether an initial PDP context shall be established automatically following an attach procedure when the UE is attached to E-UTRAN RAT with or without a PDN connection.

Changing <n> will never cause a PDP context deactivation.



SARA-R4
The <n> parameter is mandatory.



SARA-R422 / SARA-R422M8S / SARA-R422S
After changing the <attach_without_PDN> parameter setting, reboot the module ([AT+CFUN=15](#)) to make the new configuration effective.



SARA-R410M-63B / SARA-R410M-73B
Since NB-IoT RAT is not supported, the command is not effective.

13.18.2 Syntax

| Type | Syntax | Response | Example |
|------|---------------------------------------|--|-----------------------------|
| Set | AT+CIPCA=[<n>[,<attach_without_PDN>]] | OK | AT+CIPCA=1 OK |
| Read | AT+CIPCA? | +CIPCA: <n>,<attach_without_PDN> OK | +CIPCA: 1,0 OK |
| Test | AT+CIPCA=? | +CIPCA: (list of supported <n>s), (list of supported <attach_without_PDN>s) OK | +CIPCA: (0,1,3),(0,1) OK |

13.18.3 Defined values

| Parameter | Type | Description |
|-----------|--------|---|
| <n> | Number | Activation of PDP context upon attach. Allowed values: <ul style="list-style-type: none"> 0: do not activate. If the <n> parameter differs than 0, deactivating the last (active) PDP context can lead to a (re)establishment of the initial PDP context. 1: always activate. Setting this value from 0 causes an immediate attempt to (re)establish the initial PDP context if no PDP context is active. 3: no change in current setting. This value applies to E-UTRAN RAT. Allowed values: <ul style="list-style-type: none"> SARA-R4 - 0 (factory-programmed value) |

| Parameter | Type | Description |
|----------------------|--------|--|
| <attach_without_PDN> | Number | EPS attach with or without PDN connection: <ul style="list-style-type: none"> 0 (factory-programmed value): EPS attach with PDN connection 1: EPS attach without PDN connection  SARA-R4 The parameter is effective for LTE NB-IoT RAT only. |

13.19 PDP IP configuration when roaming +UDCONF=75

| +UDCONF=75 | | | | | | |
|-------------------|---|---------------------|-----------------------|-----------------------|----------------------|------------------------|
| Modules | SARA-R410M-02B SARA-R410M-52B SARA-R410M-63B SARA-R410M-73B SARA-R410M-83B SARA-R412M SARA-R422 SARA-R422M8S SARA-R422S SARA-N4 | | | | | |
| Attributes | Syntax | PIN required | Settings saved | Can be aborted | Response time | Error reference |
| | full | Yes | NVM | No | - | +CME Error |

13.19.1 Description

Configures the PDP IP when roaming. When set, the PDP IP can be limited to IPv4, IPv6, or IPv4v6 when roaming on a network.

 The configuration will be effective at the next power on.

 Only one PDP profile can be set using this command.

13.19.2 Syntax

| Type | Syntax | Response | Example |
|------|----------------------------------|---------------------------------------|---------------------------------------|
| Set | AT+UDCONF=75,<cid>,<PDP_IP_conf> | OK | AT+UDCONF=75,1,0 OK |
| Read | AT+UDCONF=75 | +UDCONF: 75,<cid>,<PDP_IP_conf> OK | AT+UDCONF=75 +UDCONF: 75,1,0 OK |

13.19.3 Defined values

| Parameter | Type | Description |
|---------------|--------|--|
| <cid> | Number | See <cid>. |
| <PDP_IP_conf> | Number | PDP IP configuration when roaming: <ul style="list-style-type: none"> 0: IP 1: IPv6 2: IPv4v6 See <PDP_type>. |

13.19.4 Notes

SARA-R4 / SARA-N4



- Set the <PDP_IP_conf> parameter before to read it.

13.20 Disable data when roaming +UDCONF=76

| +UDCONF=76 | | | | | | |
|-------------------|---|---------------------|-----------------------|-----------------------|----------------------|----------------------------|
| Modules | SARA-R410M-02B SARA-R410M-52B SARA-R410M-63B SARA-R410M-73B SARA-R410M-83B SARA-R412M SARA-R422 SARA-R422M8S SARA-R422S SARA-N4 | | | | | |
| Attributes | Syntax | PIN required | Settings saved | Can be aborted | Response time | Error reference |
| | full | No | NVM | No | - | +CME Error |

13.20.1 Description

Disables the PDP when roaming. When disabled, the PDP will not be able to send data when roaming on a network. The default value is "off".

-  The configuration will be effective at the next power on.
-  Only one PDP profile can be set using this command.

13.20.2 Syntax

| Type | Syntax | Response | Example |
|------|--------------------------------|-------------------------------------|---------------------------------------|
| Set | AT+UDCONF=76,<cid>,<Data_Flag> | OK | AT+UDCONF=76,1,0 OK |
| Read | AT+UDCONF=76 | +UDCONF: 76,<cid>,<Data_Flag> OK | AT+UDCONF=76 +UDCONF: 76,1,0 OK |

13.20.3 Defined values

| Parameter | Type | Description |
|-------------|--------|---|
| <cid> | Number | See <cid> . |
| <Data_Flag> | Number | PDP data configuration when roaming: <ul style="list-style-type: none"> • 0 (default value): OFF - PDP is enabled when roaming • 1: ON - PDP is disabled when roaming |

13.20.4 Notes

SARA-R4 / SARA-N4

- Set the <Data_Flag> parameter before to read it.

14 System features

14.1 Firmware installation +UFWINSTALL

| +UFWINSTALL | | | | | | |
|-------------------|---------------|---------------------|-----------------------|-----------------------|----------------------|----------------------------------|
| Modules | All products | | | | | |
| Attributes | Syntax | PIN required | Settings saved | Can be aborted | Response time | Error reference |
| | full | No | No | No | - | FW Install Error |

14.1.1 Description

Triggers the FW installation procedure, starting from the file (update binary file) stored in the module file system. It could be used as a part of implementation of the FOTA procedure. The command causes a SW system reset with network deregistration.



SARA-R422 / SARA-R422M8S / SARA-R422S

During the update process, the device cannot be used to make calls, even emergency calls. Do not remove the power supply or reset the module during the installation procedure even if it is fault tolerant!

In case of power loss during the install phase, at the next module wake-up a fault is detected and the module remains in Firmware Install Mode until the end of the procedure (install terminated).

Once the command has been sent correctly, the FW resets and at the next boot-up, the FW install will start.

The command syntax differs depending on the module: see the corresponding subsection for the correct command handling.



SARA-R404M / SARA-R410M / SARA-R412M / SARA-N4

Once the +UFWINSTALL AT command has been issued, the FW installation process shall begin. If the firmware update includes a boot code update, then there is a relatively small window during the update process of this code section where an interruption, such as the removal or the loss of power supply to the module, can lead to image corruption of the module that is not recoverable.



SARA-R422 / SARA-R422M8S / SARA-R422S

During the update operations, the +UFWINSTALL URC displays the progress indication and the result operation on the interface chosen via the +UFWINSTALL command at the baud rate set by the same command as well. The progression of the installation is incremental, but the increment can be different from 1. The last URC with a value greater than 100 indicates the update operation result (e.g. 128 means operation completed with success). For more details about firmware install final result codes, (see [FWINSTALL error result codes](#)). After this last result code, the device will reset and enter a normal mode of operation with new firmware updated.



SARA-R404M / SARA-R410M / SARA-R412M / SARA-N4

At the end of a successful installation, the main firmware software boots up and the SIM is reset (the PIN will be required if enabled).



Refer to SARA-R4 Firmware update with uFOTA, FOAT and EasyFlash application note [\[55\]](#) for information concerning NVM after installing the firmware.

14.1.2 SARA-R404M / SARA-R410M / SARA-R412M / SARA-N4 syntax

| Type | Syntax | Response | Example |
|------|-----------------|-------------------------------|---------------------|
| Set | AT+UFWINSTALL | OK | AT+UFWINSTALL OK |
| Test | AT+UFWINSTALL=? | OK | OK |
| URC | | +UFWINSTALL: <status_install> | |

14.1.3 SARA-R422 / SARA-R422M8S / SARA-R422S syntax

| Type | Syntax | Response | Example |
|-------------------------|---|----------|------------------------|
| Firmware upgrade | | | |
| Set | AT+UFWINSTALL[=<Serial_Port_Number>[,<BaudRate>]] | OK | AT+UFWINSTALL=1,115200 |

| Type | Syntax | Response | Example |
|---------------------------------------|--|---|--|
| | | | OK |
| Configure uFOTA FW update URCs | | | |
| Set | AT+UFWINSTALL=[<Serial_Port_Number>],[<BaudRate>],[<Reserved>],<uFOTA_URC> | OK | AT+UFWINSTALL=1,115200,,1 OK |
| Test | AT+UFWINSTALL=? | +UFWINSTALL: (list of supported <Serial_Port_Number>s),(list of supported <BaudRate>s),(list of supported <uFOTA_URC>s) OK | +UFWINSTALL: (0,2),(9600,19200,38400,57600,115200,230400,460800),(1) OK |
| URC | | +UFWINSTALL: <progress_install> | |

14.1.4 SARA-R422 / SARA-R422M8S / SARA-R422S defined values

| Parameter | Type | Description |
|----------------------|--------|---|
| <Serial_Port_Number> | Number | Serial interface where the progress percentage and the information text responses will be sent: <ul style="list-style-type: none"> • 0: no info will be shown. In this case the <BaudRate> parameter is ignored • 1: UART interface • 2: AUX UART interface If omitted, the command will take as default value for <Serial_Port_Number> the port where the command is issued. |
| <BaudRate> | Number | Available baud rates expressed in b/s: <ul style="list-style-type: none"> • 9'600 • 19'200 • 38'400 • 57'600 • 115'200 • 230'400 • 460'800 If omitted, the command will take the current value set for the <BaudRate> parameter as the baud rate to be used during the FW installation. |
| <Reserved> | String | Reserved for future usage |
| <uFOTA_URC> | String | Allowed value: <ul style="list-style-type: none"> • 1: enables the +UFWINSTALL URCs during the next FW upgrade by means of uFOTA; the URCs will be issued on the specified <Serial_Port_Number> using the specified <BaudRate>. If the <Serial_Port_Number> parameter is omitted, the URCs will be issued on the port where the command has been issued. If the <BaudRate> parameter is omitted, the current value set for the <BaudRate> parameter will be used. For more details, see the SARA-R4 series Firmware update with uFOTA, FOAT and EasyFlash application note [55]. The parameter setting is stored in the file system and is persistent across power cycles. |
| <progress_install> | Number | Provide the installation progress from 1 to 100 and the update result (see FWINSTALL error result codes). |

14.1.5 Notes

SARA-R404M / SARA-R410M / SARA-R412M / SARA-N4

- After the command is issued, the module reboots and starts the install process which can take up to 20 minutes long. No result codes are issued on the terminal during this phase and both UART and USB interfaces are unavailable for the communication. At the end of the update process the module reboots again with the new firmware installed.
- Store the update file on the device; the procedure for storing is up to the user (+UFTPC, +UFWUPD or +UDWNFILE).
- The +UFWINSTALL URC is not supported.

SARA-R422 / SARA-R422M8S / SARA-R422S

- After the command is issued, the module reboots and starts the install process which can take up to 35 minutes long.
- Store the update file into the module file system before starting the install with +UFWINSTALL AT command. Otherwise the "FFS file not found" error result code is issued. The procedure for FS storing is up to the user (by means of the +UDWNFILE, +UFWUPD or +UFTPC AT commands). When the new FW has been installed, the update file is deleted from the file system.

| Command | Response | Description |
|------------------------|------------------|---|
| AT+UFWINSTALL=1,115200 | OK | The "OK" final result code is printed out just before the FW reset. |
| | +UFWINSTALL: 1 | |
| | +UFWINSTALL: 2 | |
| | +UFWINSTALL: 3 | |
| | +UFWINSTALL: 4 | |
| | | |
| | +UFWINSTALL: 9 | The progression of installation is incremental (the subsequent increment of <progress_install> can be more than 1). |
| | +UFWINSTALL: 12 | |
| | +UFWINSTALL: 15 | |
| | | |
| | +UFWINSTALL: 99 | |
| | +UFWINSTALL: 100 | The installation is done when the percentage ends with +UFWINSTALL: 100. |
| | +UFWINSTALL: 128 | The last URC with a value greater than 100 indicates the update operation result (e.g. 128 means operation completed with success (for more details see the FWINSTALL error result codes). |

Table 12: +UFWINSTALL example

14.2 Firmware update Over AT (FOAT) +UFWUPD

| +UFWUPD | | | | | | |
|------------|--------------|--------------|----------------|----------------|---------------|----------------------------|
| Modules | All products | | | | | |
| Attributes | Syntax | PIN required | Settings saved | Can be aborted | Response time | Error reference |
| | partial | No | No | No | < 20 s | FOAT Error |

14.2.1 Description

Triggers the download of the update package using the Xmodem or Xmodem-1k protocol. The host must start the download process on the primary UART interface at speed set by IPR AT command, (the default setting is 115200 b/s). After the successful download, use the +UFWINSTALL AT command to start the firmware update with the update package just downloaded.

- The errors (data corruption, data loss, etc.) during the Update phase are internally handled by the Xmodem protocol itself; for more details about the error result codes, see [FOAT error result codes](#).
- If no data comes to the module after having issued the AT+UFWUPD command, up to ten NACK are sent and then Firmware Update Mode is dropped out coming back to normal mode; the FW is unchanged and still useable (ERROR1).

Making use of the file triggers the firmware download using the Xmodem or Xmodem-1k protocols.

- In case of power loss during the download by AT+UFWUPD command, at the next module wake-up the module is again in normal mode.
- For more details, see the SARA-R4 series firmware update with uFOTA, FOAT and EasyFlash application note [55].

14.2.2 Syntax

| Type | Syntax | Response | Example |
|------|----------------------|------------------|-------------|
| Set | AT+UFWUPD=<filetype> | +UFWUPD: ONGOING | AT+UFWUPD=3 |

| Type | Syntax | Response | Example |
|------|-------------|---|---|
| | | CCC<NACK><NACK><NACK> <NACK><NACK><NACK><NACK> <NACK><NACK><NACK> OK | +UFWUPD: ONGOING CCC<NACK><NACK><NACK> <NACK><NACK><NACK><NACK> <NACK><NACK><NACK> OK |
| Test | AT+UFWUPD=? | +UFWUPD: (list of supported <filetype>s) OK | +UFWUPD: (3) OK |

14.2.3 Defined values

| Parameter | Type | Description |
|------------|--------|---|
| <filetype> | Number | Download type: <ul style="list-style-type: none"> 3: firmware image update |

14.2.4 Notes

SARA-R404M

- Status updates on the file transfer via CCC or <NACK><NACK><NACK> are not sent to the terminal.

SARA-R422 / SARA-R422M8S / SARA-R422S

- Additional rate:** in addition to the allowed IPR values for the download, it is possible to set the baud rate also to 921,600 or 3,000,000 b/s before triggering the file download by means of the AT+UFWUPD=3 command. Increasing the baud rate to 921,600 or 3,000,000 b/s will reduce the time required for the firmware download.

| Command | Response | Description |
|----------------|------------------------------------|---|
| AT+IPR=3000000 | OK | Set the baud rate to 3,000,000. Also the host baud rate shall be set to 3,000,000 b/s. |
| AT+UFWUPD=3 | +UFWUPD: ONGOING CCC..... OK | The download rate will be at 3,000,000 b/s with Xmodem or Xmodem-1k protocol. |

Table 13: Additional baud rate for +UFWUPD

14.3 Antenna detection +UANTR

| +UANTR | | | | | | |
|------------|--------------|--------------|----------------|----------------|---------------|-----------------|
| Modules | All products | | | | | |
| Attributes | Syntax | PIN required | Settings saved | Can be aborted | Response time | Error reference |
| | full | No | No | No | - | +CME Error |

14.3.1 Description

Measures the DC component of load of the cellular antenna (the GPS antenna is RFU). The antenna load is expressed in kOhm.

14.3.2 Syntax

| Type | Syntax | Response | Example |
|------|-------------------------|--|----------------------------------|
| Set | AT+UANTR=[<antenna_id>] | +UANTR: <antenna_id>,<antenna_ load> OK | AT+UANTR=0 +UANTR: 0,10 OK |
| Test | AT+UANTR=? | +UANTR: (list of supported <antenna_id>s) OK | +UANTR: (0) OK |

14.3.3 Defined values

| Parameter | Type | Description |
|----------------|--------|---|
| <antenna_id> | Number | Antenna identifier: <ul style="list-style-type: none"> 0 (default value): cellular antenna |
| <antenna_load> | Number | Measured value in kOhm of the antenna load with a resolution of 1 kOhm. The range goes from -1 to 53 (only integer values can be assumed), where: <ul style="list-style-type: none"> -1: open circuit 0: short circuit 1: 1 kOhm (minimum limit of the measurement range) ... 53: 53 kOhm (maximum limit of the measurement range) |

14.3.4 Notes

- The load resistor values below the minimum limit of 1 kOhm are identified as short circuit (<antenna_load>=0), while values above the maximum limit of 53 kOhm are identified as open circuit (<antenna_load>=-1).
- The reported value could differ from the real resistance value of the diagnostic resistor mounted inside the antenna assembly due to antenna cable length, antenna cable capacity and the measurement method.

14.4 Production test +UTEST

| +UTEST | | | | | | |
|------------|--------------|--------------|----------------|----------------|---------------|-----------------|
| Modules | All products | | | | | |
| Attributes | Syntax | PIN required | Settings saved | Can be aborted | Response time | Error reference |
| | partial | No | NVM | No | Up to 1 s | +CME Error |

14.4.1 Description

Enables the module testing on the RF parts and all the digital pins.



The usage of this command shall be restricted to controlled (shielded chamber/box) environments and for test purposes only. Improper usage of this command on a real network could disturb other users and the network itself.



u-blox assumes no responsibility for the inappropriate use of this command.



SARA-R404M / SARA-R410M / SARA-R412M / SARA-N4

For more test command examples, guidance about test equipment setup, and more information on module reboot, see the SARA-R4 series application development guide [16].



SARA-R422 / SARA-R422M8S / SARA-R422S

For more test command examples, guidance about test equipment setup, and more information on module reboot, see the SARA-R422 series application development guide [17].

14.4.2 RF test description

Sets the module in non-signalling (or test) mode, or returns to the signalling (or normal) mode.

In non-signalling mode, the module switches off the protocol stack for performing single tests which could not be performed during signalling mode.

When entering the test mode, it is possible to sequentially trigger the following actions for testing purposes (also depending on the RATs supported by the module):

- 2G transmission of a GSM burst sequence on the desired channel and power level (only one time slot configuration is available)
- 2G transmission of an 8-PSK modulation burst sequence on the desired channel and power level (only one time slot configuration is available)
- 4G transmission of an LTE SC-FDMA OFDM signal (5 MHz bandwidth) in the desired channel in the FDD band and power level
- Receiving signal detection and RF level measurement on the desired 2G or 4G (LTE) channel

- Receiving signal detection at diversity or secondary antenna input and RF level measurement on the desired 2G or 4G (LTE) channel

The command only accepts the parameter set supported by the specific module version. When an unsupported parameter is issued, an error result code will be provided ("CME ERROR: operation not supported" or "CME ERROR: 4" depending on the +CMEE AT command setting).

The execution of these actions is performed in non-signalling mode. In non-signalling mode:

- The module accepts some non-signaling related commands. Although it is recommended that only +UTEST commands are used.
- The +CMEE AT command cannot be set.

In normal mode:

- Before entering the test mode, a network deregistration is needed: issue the AT+CFUN=0 command to deactivate the protocol stack
- The only allowed +UTEST command is the AT+UTEST=1 used to enable the test mode; in this case, the module enters automatically in test mode (+CFUN: 5)
- All other +UTEST commands return an error result code ("CME ERROR: operation not allowed" or "CME ERROR: 3" depending on the +CMEE AT command setting)

To return to the normal mode:

- SARA-R422 / SARA-R422M8S / SARA-R422S - issue AT+UTEST=0. Thereafter issue the AT+CFUN=1 command to restore the MT full functionality.
- SARA-R404M / SARA-R410M / SARA-R412M / SARA-N4 - issue AT+UTEST=0 and then reboot (by means of AT+CFUN=15) or power off the module. Thereafter the MT full functionality, (+CFUN:1) is automatically restored.

SARA-R422 / SARA-R422M8S / SARA-R422S
RF testing of channels belonging to different RATs (2G, LTE) is allowed by resetting the test mode in this case the following commands sequence has to be sent between the two measurements: AT+UTEST=0, AT+CFUN=1, AT+CFUN=0, AT+UTEST=1.

SARA-R412M
RF testing of channels belonging to different RATs (2G, LTE) is allowed by resetting the test mode in this case the following commands sequence has to be sent between the two measurements: AT+UTEST=0, AT+UTEST=1, AT+CFUN=15 and AT+UTEST=1.

14.4.3 Syntax

| Type | Syntax | Response | Example |
|-----------------------------|---|--|---|
| Generic syntax | | | |
| Set | AT+UTEST=<mode>[[<param_val1>],[<param_val2>],[<param_val3>],[<param_val4>],[<param_val5>]]]] | [+UTEST: [<param_val1>,<param_val2>],[<param_val3>],[<param_val4>,<param_val5>],[<min>,<avg>,<max>]] OK | AT+UTEST=0 OK |
| Entering normal mode | | | |
| Set | AT+UTEST=0 | OK | AT+UTEST=0 OK |
| Entering test mode | | | |
| Set | AT+UTEST=1 | OK | AT+UTEST=1 OK |
| RX test mode | | | |
| Set | AT+UTEST=2[[<RX_channel>],[<RX_time_interval>],[<receiver_path>]]]] | +UTEST: <RX_channel>,<RX_time_interval>,<receiver_path>,<min>,<avg>,<max> OK | AT+UTEST=2,124,250 +UTEST: 124,250,0,-80,-80,-80 OK |
| TX test mode | | | |
| Set | AT+UTEST=3[[<TX_channel>],[<power_control_level>],[<training_sequence>]] | +UTEST: <TX_channel>,<power_control_level>,<training_sequence> +UTEST: 32,7,5,1,1000 | AT+UTEST=3,32,7,5 +UTEST: 32,7,5,1,1000 |

| Type | Syntax | Response | Example |
|---|---|--|-----------------------------------|
| | sequence>],[[<modulation_mode>],[<TX_time_interval>]]]]]] | <modulation_mode>,<TX_time_interval> OK | OK |
| Antenna dynamic tuner configuration mode | | | |
| Set | AT+UTEST=4,<ant_tuner_enable> | +UTEST: 4,<ant_tuner_enable> OK | AT+UTEST=4,1 +UTEST: 4,1 OK |
| Read | AT+UTEST? | +UTEST: <mode> OK | +UTEST: 1 OK |
| Test | AT+UTEST=? | +UTEST: (list of supported <mode>s) OK | +UTEST: (0-3) OK |

14.4.4 Defined values

| Parameter | Type | Description |
|-----------------------|--------|---|
| <mode> | Number | Test mode setting: <ul style="list-style-type: none"> 0: the module returns to the normal mode 1: the module enters the test mode 2: RX test mode (measuring the antenna level estimation of the received RF signal) 3: TX test mode (GSMK/8-PSK burst or transmission in 3G bands) 4: antenna dynamic tuner configuration mode (enable/disable antenna dynamic tuner control) |
| <RX_channel> | Number | For the parameter description and its range, see Notes . |
| <RX_time_interval> | Number | For the parameter description and its range, see Notes . |
| <receiver_path> | Number | For the parameter description and its range, see Notes . |
| <expected_power> | Number | For the parameter description and its range, see Notes . |
| <measured_power> | Number | For the parameter description and its range, see Notes . |
| <TX_channel> | Number | For the parameter description and its range, see Notes . |
| <power_control_level> | Number | For the parameter description and its range, see Notes . |
| <training_sequence> | Number | For the parameter description and its range, see Notes . |
| <modulation_mode> | Number | For the parameter description and its range, see Notes . |
| <TX_time_interval> | Number | For the parameter description and its range, see Notes . |
| <ant_tuner_enable> | Number | Enable/disable antenna dynamic tuner control. Allowed values: <ul style="list-style-type: none"> 0 (factory-programmed value): antenna dynamic tuner control disabled 1: antenna dynamic tuner control enabled |
| <param_valx> | Number | Supported content depends on related <mode> (details are given above). |

14.4.5 Notes

SARA-R4 / SARA-N4

- <mode>=4 (antenna dynamic tuner configuration mode) is not supported.
- The <expected_power> and <measured_power> parameters are not supported.

SARA-R4 / SARA-N4

- Check the corresponding module data sheet for the list of supported bands and radio access technologies (RAT).
- RX mode setting (<mode>=2)**

| Parameter | Description | Range | Default | Notes |
|--------------|-------------|---------------------------------|---------|---|
| <RX_channel> | Channel | 0 ÷ max value of supported band | 32 | RX channel 2G RAT: for 850, 900, 1800 bands the value corresponds to ARFCN while for 1900 band an offset of 32768 is added. <ul style="list-style-type: none"> [0-124]: GSM 900 MHz [128-251]: GSM 850 MHz [512-885]: DCS 1800 MHz [975-1023]: EGSM 900 MHz |

| Parameter | Description | Range | Default | Notes |
|-----------|-------------|-------|---------|---|
| | | | | <ul style="list-style-type: none"> o [33280-33578]: PCS 1900 MHz (corresponding to ARFCN 512-810 range in band 1900) <p>RX channel 3G RAT: the value corresponds to UARFCN except for band 19 where an offset of 20000 is added, additional channels available in some 3G bands are not supported.</p> <ul style="list-style-type: none"> o [1537-1738]: band 4 (1700 MHz) o [2937-3088]: band 8 (900 MHz) o [4357-4458]: band 5 (850 MHz) o [4387-4413]: band 6 (800 MHz) o [20712-20763]: band 19 (800 MHz) o [9662-9938]: band 2 (1900 MHz) o [10562-10838]: band 1 (2100 MHz) o [10050-10125]: TD-SCDMA band 34 (2000 MHz) o [9400-9600]: TD-SCDMA band 39 (1900 MHz) <p>RX channel 4G RAT: the value corresponds to EARFCN with an offset of 100000.</p> |

| <RX_channel> range | LTE band | EARFCN range |
|--------------------|----------|---------------|
| [100000-100599] | FDD 1 | [0-599] |
| [100600-101199] | FDD 2 | [600-1199] |
| [101200-101949] | FDD 3 | [1200-1949] |
| [101950-102399] | FDD 4 | [1950-2399] |
| [102400-102649] | FDD 5 | [2400-2649] |
| [102650-102749] | FDD 6 | [2650-2749] |
| [102750-103449] | FDD 7 | [2750-3449] |
| [103450-103799] | FDD 8 | [3450-3799] |
| [103800-104149] | FDD 9 | [3800-4149] |
| [104150-104749] | FDD 10 | [4150-4749] |
| [104750-104949] | FDD 11 | [4750-4949] |
| [105010-105179] | FDD 12 | [5010-5179] |
| [105180-105279] | FDD 13 | [5180-5279] |
| [105280-105379] | FDD 14 | [5280-5379] |
| [105730-105849] | FDD 17 | [5730-5849] |
| [105850-105999] | FDD 18 | [5850-5999] |
| [106000-106149] | FDD 19 | [6000-6149] |
| [106150-106449] | FDD 20 | [6150-6449] |
| [106450-106599] | FDD 21 | [6450-6599] |
| [106600-107399] | FDD 22 | [6600-7399] |
| [107500-107699] | FDD 23 | [7500-7699] |
| [107700-108039] | FDD 24 | [7700-8039] |
| [108040-108689] | FDD 25 | [8040-8689] |
| [108690-109039] | FDD 26 | [8690-9039] |
| [109210-109659] | FDD 28 | [9210-9659] |
| [109660-109769] | FDD 29 | [9660-9769] |
| [109770-109869] | FDD 30 | [9770-9869] |
| [109870-109919] | FDD 31 | [9870-9919] |
| [109920-110359] | FDD 32 | [9920-10359] |
| [136000-136199] | FDD 33 | [36000-36199] |
| [136200-136349] | TDD 34 | [36200-36349] |
| [136350-136949] | TDD 35 | [36350-36949] |
| [136950-137549] | TDD 36 | [36950-37549] |
| [137550-137749] | TDD 37 | [37550-37749] |
| [137750-138249] | TDD 38 | [37750-38249] |
| [138250-138649] | TDD 39 | [38250-38649] |
| [138650-139649] | TDD 40 | [38650-39649] |
| [139650-141589] | TDD 41 | [39650-41589] |

| Parameter | Description | Range | Default | Notes |
|-----------|-------------|-------|---------|---|
| | | | | <RX_channel> range LTE band EARFCN range |
| | | | | [141590-143589] TDD 42 [41590-43589] |
| | | | | [143590-145589] TDD 43 [43590-45589] |
| | | | | [145590-146589] TDD 44 [45590-46589] |
| | | | | [165536-166435] FDD 65 [65536-66435] |
| | | | | [166436-167335] FDD 66 [66436-67335] |
| | | | | [167336-167535] FDD 67 [67336-67535] |
| | | | | [167536-167835] FDD 68 [67536-67835] |
| | | | | [167836-168335] FDD 69 [67836-68335] |
| | | | | [168336-168585] FDD 70 [68336-68585] |
| | | | | [168586-168935] FDD 71 [68586-68935] |
| | | | | [170366-170545] FDD 85 [70366-70545] |

Table 14: <RX_channel> parameter range

The "+CME ERROR: operation not supported" or "+CME ERROR: 4" error result code will be provided in these cases (depending on the +CMEE AT command setting):

- o A value not belonging to the above ranges is set
- o The RX channel parameter value belongs to a non-supported RAT (2G or 3G or 4G RAT) or band

The default channel will be equal to 32 if the GSM RAT is supported, in the other cases it will be the same as the central channel of the lower LTE band supported by the module.

SARA-R4 SARA-N4
The first seven and the last seven EARFCN units in the EARFCN range of every LTE band are not supported (e.g. for FDD 8 band, the channels from 103450 to 103456 and the channels from 103793 to 103799, which corresponds respectively to EARFCN from 3450 to 3456 and from 3793 to 3799, are not supported).

| | | | | |
|--------------------|-------------------------------------|---------------------------|------|---|
| <RX_time_interval> | Time | 1 ÷ 600000 | 1000 | Time interval for RX test expressed in milliseconds |
| <receiver_path> | Antenna diversity | 0 ÷ 1 | 0 | Receiver path: <ul style="list-style-type: none"> o 0: main / primary antenna o 1: diversity / secondary antenna The parameter is available only if supported, otherwise an error result code will be provided ("+CME ERROR: operation not supported" or "+CME ERROR: 4" depending on the +CMEE AT command setting) |
| <min> | Minimum antenna RF level estimation | See Notes | | Expressed in dBm |
| <avg> | Average antenna RF level estimation | See Notes | | Expressed in dBm |
| <max> | Maximum antenna RF level estimation | See Notes | | Expressed in dBm |

- RF level estimation range:
 - o SARA-R4 / SARA-N4 - The range is [-75 ÷ -20].
- **TX mode setting (<mode>=3)**

| Parameter | Description | Range | Default | Notes |
|--------------|-------------|---------------------------------|---------|---|
| <TX_channel> | Tx channel | 0 ÷ max value of supported band | 32 | <p>TX channel 2G RAT: for 850, 900, 1800 bands the value corresponds to ARFCN while for 1900 band an offset of 32768 is added.</p> <ul style="list-style-type: none"> o [0-124]: GSM 900 MHz o [128-251]: GSM 850 MHz o [512-885]: DCS 1800 MHz o [975-1023]: EGSM 900 MHz o [33280-33578]: PCS 1900 MHz (corresponding to ARFCN 512-810 range in band 1900) <p>TX channel 3G RAT: the value corresponds to UARFCN except for the band 19 where an offset of 20000 is added, additional channels available in some 3G bands are not supported.</p> <ul style="list-style-type: none"> o [1312-1513]: band 4 (1700 MHz) o [2712-2863]: band 8 (900 MHz) o [4132-4233]: band 5 (850 MHz) o [4162-4188]: band 6 (800 MHz) o [20312-20363]: band 19 (800 MHz) o [9262-9538]: band 2 (1900 MHz) o [9612-9888]: band 1 (2100 MHz) o [10050-10125]: TD-SCDMA band 34 (2000 MHz) o [9400-9600]: TD-SCDMA band 39 (1900 MHz) <p>TX channel 4G RAT: the value corresponds to EARFCN with an offset of 100000.</p> |

| <TX_channel> range | LTE band | EARFCN range |
|--------------------|----------|---------------|
| [118000-118599] | FDD 1 | [18000-18599] |
| [118600-119199] | FDD 2 | [18600-19199] |
| [119200-119949] | FDD 3 | [19200-19949] |
| [119950-120399] | FDD 4 | [19950-20399] |
| [120400-120649] | FDD 5 | [20400-20649] |
| [120650-120749] | FDD 6 | [20650-20749] |
| [120750-121449] | FDD 7 | [20750-21449] |
| [121450-121799] | FDD 8 | [21450-21799] |
| [121800-122149] | FDD 9 | [21800-22149] |
| [121800-122149] | FDD 10 | [21800-22149] |
| [122750-122949] | FDD 11 | [22750-22949] |
| [123010-123179] | FDD 12 | [23010-23179] |
| [123180-123279] | FDD 13 | [23180-23279] |
| [123730-123849] | FDD 17 | [23730-23849] |
| [123850-123999] | FDD 18 | [23850-23999] |
| [124000-124149] | FDD 19 | [24000-24149] |
| [124150-124449] | FDD 20 | [24150-24449] |
| [124450-124599] | FDD 21 | [24450-24599] |
| [124600-125399] | FDD 22 | [24600-25399] |
| [125500-125699] | FDD 23 | [25500-25699] |
| [125700-126039] | FDD 24 | [25700-26039] |
| [126040-126689] | FDD 25 | [26040-26689] |
| [126690-127039] | FDD 26 | [26690-27039] |
| [127040-127209] | FDD 27 | [27040-27209] |
| [127210-127659] | FDD 28 | [27210-27659] |
| [127660-127759] | FDD 30 | [27660-27759] |
| [127760-127809] | FDD 31 | [27760-27809] |
| [136200-136349] | TDD 34 | [36200-36349] |
| [137750-138249] | TDD 38 | [37750-38249] |
| [138250-138649] | TDD 39 | [38250-38649] |
| [138650-139649] | TDD 40 | [38650-39649] |

| Parameter | Description | Range | Default | Notes | | | | | | | | | | | | | | | | | | | | | | | | |
|--------------------|-------------|-----------------|---------|---|--------------------|----------|--------------|-----------------|--------|---------------|-----------------|--------|-----------------|-----------------|--------|-----------------|-----------------|--------|-----------------|-----------------|--------|-----------------|-----------------|--------|-----------------|-----------------|--------|-----------------|
| | | | | <table border="1"> <thead> <tr> <th><TX_channel> range</th> <th>LTE band</th> <th>EARFCN range</th> </tr> </thead> <tbody> <tr> <td>[139650-141589]</td> <td>TDD 41</td> <td>[39650-41589]</td> </tr> <tr> <td>[231072-231971]</td> <td>FDD 65</td> <td>[131072-131971]</td> </tr> <tr> <td>[231972-232671]</td> <td>FDD 66</td> <td>[131972-132671]</td> </tr> <tr> <td>[232672-232971]</td> <td>FDD 68</td> <td>[132672-132971]</td> </tr> <tr> <td>[232972-233121]</td> <td>FDD 70</td> <td>[132972-133121]</td> </tr> <tr> <td>[233122-233471]</td> <td>FDD 71</td> <td>[133122-133471]</td> </tr> <tr> <td>[234002-234181]</td> <td>FDD 85</td> <td>[134002-134181]</td> </tr> </tbody> </table> | <TX_channel> range | LTE band | EARFCN range | [139650-141589] | TDD 41 | [39650-41589] | [231072-231971] | FDD 65 | [131072-131971] | [231972-232671] | FDD 66 | [131972-132671] | [232672-232971] | FDD 68 | [132672-132971] | [232972-233121] | FDD 70 | [132972-133121] | [233122-233471] | FDD 71 | [133122-133471] | [234002-234181] | FDD 85 | [134002-134181] |
| <TX_channel> range | LTE band | EARFCN range | | | | | | | | | | | | | | | | | | | | | | | | | | |
| [139650-141589] | TDD 41 | [39650-41589] | | | | | | | | | | | | | | | | | | | | | | | | | | |
| [231072-231971] | FDD 65 | [131072-131971] | | | | | | | | | | | | | | | | | | | | | | | | | | |
| [231972-232671] | FDD 66 | [131972-132671] | | | | | | | | | | | | | | | | | | | | | | | | | | |
| [232672-232971] | FDD 68 | [132672-132971] | | | | | | | | | | | | | | | | | | | | | | | | | | |
| [232972-233121] | FDD 70 | [132972-133121] | | | | | | | | | | | | | | | | | | | | | | | | | | |
| [233122-233471] | FDD 71 | [133122-133471] | | | | | | | | | | | | | | | | | | | | | | | | | | |
| [234002-234181] | FDD 85 | [134002-134181] | | | | | | | | | | | | | | | | | | | | | | | | | | |

Table 15: <TX_channel> parameter range

The "+CME ERROR: operation not supported" or "+CME ERROR: 4" error result code will be provided in these cases (depending on the +CMEE AT command setting):

- o A value not belonging to the above ranges is set
- o The TX channel parameter value belongs to a non-supported RAT (2G or 3G or 4G RAT) or band

Avoid channels that would put the TX waveform outside the band due to SC-FDMA modulation bandwidth.

The default channel will be equal to 32 if the GSM RAT is supported, in the other cases it will be the same as the central channel of the lower LTE band supported by the module.

SARA-R4 SARA-N4
The first seven and the last seven EARFCN units in the EARFCN range of every LTE band are not supported (e.g. for FDD 8 band, the channels from 121450 to 121456 and the channels from 121793 to 121799, which corresponds respectively to EARFCN from 21450 to 21456 and from 21793 to 21799, are not supported).

| | | | | |
|-----------------------|---------------------|----------|---|---|
| <power_control_level> | Power control level | -56 ÷ 24 | 5 | <p>For 2G RAT: PCL (power control level). The allowed values depend on the related <TX_channel> value: lower numbers means higher power level.</p> <ul style="list-style-type: none"> o [0-19]: GSM 850 and 900, if <power_control_level> is less than 5 the handling is the same for <power_control_level>=5 o [0-15]: DCS 1800 and PCS 1900 <p>In case <modulation_mode> is set to 2 (8-PSK modulation) the range is as below. Other values are valid but behave as the indicated level:</p> <ul style="list-style-type: none"> o [0-19]: GSM 850 and 900 if <power_control_level> is less than 8 the handling is the same for <power_control_level>=8 o [0-15]: DCS 1800 and PCS 1900; if <power_control_level> is less than 2 the handling is the same for <power_control_level>=2 <p>For 3G RAT: absolute output power [dBm]</p> <ul style="list-style-type: none"> o [-56 ÷ 24] for all the bands <p>For 4G RAT: absolute output power [dBm]</p> <ul style="list-style-type: none"> o [-40 ÷ 24] for all the bands <p> Only the values indicated in the above ranges are valid, otherwise an error result code will be provided ("+CME ERROR: operation not supported" or "+CME ERROR: 4" depending on the +CMEE AT command setting).</p> |
|-----------------------|---------------------|----------|---|---|

| Parameter | Description | Range | Default | Notes |
|---------------------|-------------------|------------|---------|--|
| <training_sequence> | Training sequence | 0 ÷ 7 | 5 | Training sequence to be used (to be changed only in case of link with network simulator, else use default) In 3G / 4G RAT the values is unused. |
| <modulation_mode> | Modulation mode | 1 ÷ 2 | 1 | Modulation mode: <ul style="list-style-type: none"> o 1: GMSK normal modulation including the training sequence o 2: 8-PSK normal modulation including the training sequence In 3G / 4G RAT the parameter is ignored. LTE SC-FDMA OFDM modulation (5 MHz bandwidth), FDD, is automatically set using for <TX_channel> an EARFCN value. The LTE Cat.M1 SC-FDMA OFDM modulation (1.4 MHz bandwidth), FDD, is automatically set using an EARFCN value for the <TX_channel> parameter. |
| <TX_time_interval> | Time | 0 ÷ 600000 | 1000 | Time interval for TX test expressed in milliseconds <ul style="list-style-type: none"> o 0: burst sequence is continuously transmitted. In this case the command will immediately return the information text response. The command line will be immediately available for any +UTEST command. Provide AT+UTEST=1 command to stop the burst sequence transmission, any other +UTEST commands can be set and the current sequence transmission is stopped. |

14.4.6 SARA-R4 RF test description examples

In [RX mode test command examples](#) the information text response is issued after the timeout configured in the set command.

| Command | Response | Description |
|-------------------------|---|--|
| 2G RX examples | | |
| AT+UTEST=2 | +UTEST: 32,1000,-89,-88,-87 OK | The module measures the antenna RX level at RX channel 32 band GSM 900 for 1 s interval. In the example -89,-88,-87 are the antenna RF level estimation: the numbers are just an example. |
| AT+UTEST=2,885,5000 | +UTEST: 885,5000,-66,-65,-65 OK | The module measures the antenna RX level at RX channel 885 band DCS 1800 for 5 s interval. |
| AT+UTEST=2,65,3000,0 | +UTEST: 65,3000,0,-63,-62,-62 OK | The module measures the antenna RX level at RX channel 65 band GSM 900 for 3 s interval on the main antenna path. |
| 3G RX examples | | |
| AT+UTEST=2,10562 | +UTEST: 10562,1000,0,-85,-85,-85 OK | The module measures the antenna RX level at RX channel 10562 band B1 for 1 s interval on the main antenna path. |
| AT+UTEST=2,4357,,1 | +UTEST: 4357,1000,1,-51,-51,-51 OK | The module measures the antenna RX level at RX channel 4357 band B5 for 1 s interval on the diversity antenna path. |
| 4G RX examples | | |
| AT+UTEST=2,102174,500,0 | +UTEST: 102174,500,0,-71,-70,-70 OK | The module measures the antenna RX level at RX channel 2174 band FDD 4 for 0.5 s interval on the primary antenna path. |
| AT+UTEST=2,105230,,1 | +UTEST: 105230,1000,1,-72,-71,-70 OK | The module measures the antenna RX level at RX channel 5230 band FDD 13 for 1 s interval on the secondary antenna path. |

| Command | Response | Description |
|-----------------------|--|---|
| AT+UATEST=2,109690,,0 | +UATEST: 109690,1000,0,-52,-51,-50 OK | The module measures the antenna RX level at RX channel 9690 band FDD 29 for 1 s interval on the primary antenna path. |
| AT+UATEST=2,109690,,1 | +UATEST: 109690,1000,1,-52,-51,-50 OK | The module measures the antenna RX level at RX channel 9690 band FDD 29 for 1 s interval on the secondary antenna path. |

Table 16: RX mode test command examples

| Command | Response | Description |
|------------------------------|-----------------------------------|--|
| 2G TX examples | | |
| AT+UATEST=3,32,7,5 | +UATEST: 32,7,5,1,1000 OK | The module will transmit for 1 s interval 1 slot burst sequence at TX channel 32 GSM 900 at PCL 5 using training sequence 5 and normal GMSK modulation. |
| AT+UATEST=3,65,8,,2,5000 | +UATEST: 65,8,5,2,5000 OK | The module will transmit for 5 s interval 1 slot burst sequence at TX channel 65 GSM 900 at PCL 8 (gamma 6, 27 dBm) using training sequence 5 and normal 8-PSK modulation. |
| AT+UATEST=3,660,,,,0 | +UATEST: 660,5,5,1,0 OK | The module will transmit continuously 1 slot burst sequence at TX channel 660 DCS 1800 at PCL 5 using training sequence 5 and normal GMSK modulation. |
| 3G TX examples | | |
| AT+UATEST=3,9612,22,,,2000 | +UATEST: 9612,22,5,1,2000 OK | The module will transmit for 2 s interval at TX channel 9612 band B1 at 22 dBm power level using WCDMA modulation. |
| 4G TX examples | | |
| AT+UATEST=3,120399,15,,,3000 | +UATEST: 120399,15,5,1,3000 OK | The module transmits for 3 s interval at TX channel 20399 band FDD 4 at 15 dBm power level using SC-FDMA OFDM modulation 5 MHz bandwidth. |
| AT+UATEST=3,123230,-10,,,0 | +UATEST: 123230,-10,5,1,0 OK | The module continuously transmits at TX channel 23230 band FDD 13 at -10 dBm power level using SC-FDMA OFDM modulation 5 MHz bandwidth. |

Table 17: TX mode test command examples

14.4.7 Digital pins testing description

Defines the commands to perform some verifications on all the digital pins of the u-blox cellular modules.

These pins can be considered as generic digital input / output pins; it is possible to configure one pin as a digital output with "high" logic level and then verify the voltage level present. Conversely, it is possible set a pin as a digital input, externally apply a "high" or "low" logic level and then check if the module is able to correctly measure the voltage level applied.

After the execution of the AT+UATEST=10,5 command, it is possible to externally apply a voltage level to the enabled input pins and / or measure the voltage level on the pins configured as digital input.



These commands are intended for production to check the correct digital pins behavior, detect possible soldering or functional problems and can be executed only in non-signalling mode (otherwise the "+CME ERROR: operation not allowed" or "+CME ERROR: 3" error result code - depending on the +CME AT command setting - is issued without performing any operations).



Do not exceed the values reported in the Generic Digital Interface section of the module data sheet when testing a pin as a digital input pin, since stressing the device above the listed ratings may cause a permanent damage of the module.



The <op_code>, <bit_padding>, <pin_seq> parameters setting is not stored in the NVM.



SARA-R404M / SARA-R410M / SARA-R412M / SARA-N4

See the SARA-R4 application development guide [16] and the corresponding module data sheet for the list of pins available for testing and their levels characteristics and further test command examples.



SARA-R422 / SARA-R422M8S / SARA-R422S

See the SARA-R422 application development guide [17] and the corresponding module data sheet for the list of pins available for testing and their levels characteristics and further test command examples.

14.4.8 Syntax

| Type | Syntax | Response | Example |
|--|---|---|---|
| Digital pins testing generic syntax | | | |
| Set | AT+UTEST=10,<op_code>[, [<bit_padding>]<pin_seq>] | OK | AT+UTEST=10,3,"0000001000000300" OK |
| Original configuration restoring | | | |
| Set | AT+UTEST=10,0 | OK | AT+UTEST=10,0 OK |
| Pins set definition | | | |
| Set | AT+UTEST=10,2,[<bit_padding>]<pin_seq> | OK | AT+UTEST=10,2,"0000000C30000003000" OK |
| Pins configuration | | | |
| Set | AT+UTEST=10,3,[<bit_padding>]<pin_seq> | OK | AT+UTEST=10,3,"0000000420000001000" OK |
| Output pins definition | | | |
| Set | AT+UTEST=10,4,[<bit_padding>]<pin_seq> | OK | AT+UTEST=10,4,"00000000100000002000" OK |
| Digital testing execution | | | |
| Set | AT+UTEST=10,5 | OK | AT+UTEST=10,5 OK |
| Digital value measurement | | | |
| Set | AT+UTEST=10,6 | <bit_padding>]<pin_seq> OK | AT+UTEST=10,6 00000004100000003000 OK |
| Read | AT+UTEST? | +UTEST: <mode> OK | +UTEST: 1 OK |
| Test | AT+UTEST=? | +UTEST: (list of supported <mode>s) OK | +UTEST: (0-3) OK |

14.4.9 Defined values

| Parameter | Type | Description |
|-----------|--------|---|
| <op_code> | Number | Test mode setting: <ul style="list-style-type: none"> 0: exits the digital test mode and restores the pins to the original configuration 2: defines a set of pins that will be tested and initializes these pins to be ready for testing. The original pins configuration is kept for final restore. In the [<bit_padding>]<pin_seq> parameter use this notation to represent each module pin with its binary digit: <ul style="list-style-type: none"> o 0: the pin will not be tested o 1: the pin will be tested (as digital input or output) 3: configures the logical pins previously enabled for testing as output or input; the command has effect only if AT+UTEST=10,2 has been previously issued. |

| Parameter | Type | Description |
|------------------------|--------|--|
| | | <p>In case a non enabled pin is set as digital input or output, the command does not return an error and the setting is not applied. In the [<bit_padding>]<pin_seq> parameter use this notation to represent each module pin with its binary digit:</p> <ul style="list-style-type: none"> o 0: the pin will be set as an output o 1: the pin will be set as an input <ul style="list-style-type: none"> • 4: configures the value of the output pins under testing; the command has effect only if AT+UTEST=10,3 has been previously issued; The command is not mandatory if there are no output pins to configure. In the [<bit_padding>]<pin_seq> parameter use this notation to represent each module pin with its binary digit: <ul style="list-style-type: none"> o 0: the pin will output a "low" logic level o 1: the pin will output a "high" logic level • 5: applies the setting change defined with <op_code>= 2 / 3 / 4 and triggers the execution of the digital testing. Digital testing of the pins is possible only after the execution of the AT+UTEST=10,5 command. • 6: returns the logic value of pins under testing (both input and output); in the [<bit_padding>]<pin_seq> parameter use this notation to represent each module pin with its binary digit: <ul style="list-style-type: none"> o 0: "low" logic digital level measured at the module pin o 1: "high" logic digital level measured at the module pin |
| <bit_padding><pin_seq> | Number | <p>Sequence of hexadecimal digits containing the pin information and the action to execute:</p> <ul style="list-style-type: none"> • SARA-R404M / SARA-R410M / SARA-R412M / SARA-N4 - See the Notes and the SARA-R4 application development guide, [16] for detailed number description • SARA-R422 / SARA-R422M8S / SARA-R422S - See the Notes and the SARA-R422 application development guide, [17] for detailed number description |

14.4.10 Notes

- Consider these steps to construct the [<bit_padding>]<pin_seq> sequence:
 - o Consider the total number of the module's pins available
 - SARA-R4 / SARA-N4 - 96 pins
 - o When a non-testable pin is selected, the command does not return an error result code but the value is not considered and not applied.
 - o The status of the n-th pin will be represented by the corresponding n-th bit; see the <op_code> description for the notation of each mode setting
 - o Convert each group of four binary digits into its hexadecimal representation
- SARA-R404M / SARA-R410M / SARA-R412M / SARA-N4
See the SARA-R4 application development guide [16] and the corresponding module data sheet for the list of pins available for testing and their levels characteristics and further test command examples.
- SARA-R422 / SARA-R422M8S / SARA-R422S
See the SARA-R422 application development guide [17] and the corresponding module data sheet for the list of pins available for testing and their levels characteristics and further test command examples.

SARA-R404M / SARA-R410M / SARA-R412M / SARA-N4

| Command | Response | Description |
|--|-------------------------|---|
| | | Configure the formatting of the error result code by means of +CMEE AT command |
| AT+COPS=2 | OK | Deregister the module from the network |
| AT+UTEST=1 | OK | The module enters the test mode |
| AT+UTEST=10,1 | (pin description) OK | Gets the pin information |
| AT+UTEST=10,2,"0000000000 01fa1e01c49fe0" | OK | <p>The command puts the module in Interface initialised state; the command saves the pins status to restore it at the end of the test.</p> <p>Pins enabled for testing: DSR, RI, DCD, DTR, RTS, CTS, TXD, RXD, GPIO1, GPIO6, GPIO2, GPIO3, GPIO4, I2S_WA/ SPI_MOSI, I2S_TXD/SPI_CS, I2S_CLK/SPI_CLK, I2S_</p> |

| Command | Response | Description |
|--|------------------------------|--|
| | | RXD/SPI_MISO, GPIO5, SDIO_D2, SDIO_CLK, SDIO_CMD, SDIO_D0, SDIO_D3, SDIO_D1 |
| AT+UTEST=10,3,"0000000000 01f81e00801fe0" | OK | Pins configuration: <ul style="list-style-type: none"> DSR, RI, DCD, DTR, RTS, CTS, TXD, RXD, GPIO3, I2S_WA/SPI_MOSI, I2S_TXD/SPI_CS, I2S_CLK/SPI_CLK, I2S_RXD/SPI_MISO, SDIO_D2, SDIO_CLK, SDIO_CMD, SDIO_D0, SDIO_D3, SDIO_D1 as input. GPIO1, GPIO6, GPIO2, GPIO4, GPIO5 as output. |
| AT+UTEST=10,4,"0000000000 00020000448000" | OK | Digital logic value of the output pins: <ul style="list-style-type: none"> GPIO1, GPIO6, GPIO2, GPIO5 set to "high". |
| AT+UTEST=10,5 | OK | Configurations made by AT+UTEST=10,2; AT+UTEST=10,3 and AT+UTEST=10,4 are executed. |
| AT+UTEST=10,6 | 000000000000020000 c48b00 | Logic digital value measured at modules pins: <ul style="list-style-type: none"> DTR, RTS, TXD, GPIO1, GPIO6, GPIO2, GPIO3, GPIO5: "high" level detected. |
| AT+UTEST=0 | OK | Module exits from the test mode and normal pin configuration is restored. |

Table 18: Digital pins test command examples

Issue the AT+UTEST=10,1 command to complete the digital pin test procedure. The digital pins can be configured as many times as needed by the testing process; AT+UTEST=10,2 command is not needed any more as the DUT is already in Interface initialized state.

- The UART pins must be tested using a terminal program connected via the USB interface (not UART).
- The UART test pins fails if the +UTEST command is exited and re-entered without an intervening power cycle.

SARA-R422 / SARA-R422M8S / SARA-R422S

| Command | Response | Description |
|--|-----------------------------|--|
| | | Configure the formatting of the error result code by means of +CMEE AT command |
| AT+COPS=2 | OK | Deregister the module from the network |
| AT+UTEST=1 | OK | The module enters the test mode |
| AT+UTEST=10,1 | (pin description) OK | Gets the pin information |
| AT+UTEST=10,2,"0000000000 00021E01C487E0" | OK | The command puts the module in Interface initialised state; the command saves the pins status to restore it at the end of the test. Pins enabled for testing: DSR, RI, DCD, DTR, RTS, CTS, GPIO1, GPIO6, GPIO2, GPIO3, GPIO4, I2S_WA/SPI_MOSI, I2S_TXD/SPI_CS, I2S_CLK/SPI_CLK, I2S_RXD/SPI_MISO, GPIO5 |
| AT+UTEST=10,3,"0000000000 00021E000487E0" | OK | Pins configuration: <ul style="list-style-type: none"> DSR, RI, DCD, DTR, RTS, CTS, GPIO1, GPIO6, I2S_WA/SPI_MOSI, I2S_TXD/SPI_CS, I2S_CLK/SPI_CLK, I2S_RXD/SPI_MISO, GPIO5 as input. GPIO2, GPIO3, GPIO4 as output. |
| AT+UTEST=10,4,"0000000000 00000001C00000" | OK | Digital logic value of the output pins: <ul style="list-style-type: none"> GPIO2, GPIO3, GPIO4 set to "high". |
| AT+UTEST=10,5 | OK | Configurations made by AT+UTEST=10,2; AT+UTEST=10,3 and AT+UTEST=10,4 are executed. |
| AT+UTEST=10,6 | 00000000000000001C00 300 | Logic digital value measured at modules pins: <ul style="list-style-type: none"> DTR, RTS, GPIO2, GPIO3, GPIO4: "high" level detected. |
| AT+UTEST=0 | OK | Module exits from the test mode and normal pin configuration is restored. |

Table 19: Digital pins test command examples

Issue the AT+UATEST=10,1 command to complete the digital pin test procedure. The digital pins can be configured as many times as needed by the testing process; AT+UATEST=10,2 command is not needed any more as the DUT is already in Interface initialized state.

- The UART pins must be tested using a terminal program connected via the USB interface (not UART).
- The UART test pins fails if the +UATEST command is exited and re-entered without an intervening power cycle.

14.5 MSPR profile handling configuration +UDCONF=40

| +UDCONF=40 | | | | | | |
|------------|-----------------------------------|--------------|----------------|----------------|---------------|-----------------|
| Modules | SARA-R422 SARA-R422M8S SARA-R422S | | | | | |
| Attributes | Syntax | PIN required | Settings saved | Can be aborted | Response time | Error reference |
| | partial | No | NVM | No | - | +CME Error |

14.5.1 Description

The multi-slot transmission power can be reduced according to the 3GPP specifications and set to a defined threshold.



u-blox cellular modules are certified according to all the capabilities and options stated in the Protocol Implementation Conformance Statement document (PICS) of the module. The PICS, according to 3GPP TS 51.010-2 [100], 3GPP TS 34.121-2 [101], 3GPP TS 36.521-2 [122] and 3GPP TS 36.523-2 [123], is a statement of the implemented and supported capabilities and options of a device. If the user changes the command settings during the certification process, the PICS of the application device integrating a u-blox cellular module must be changed accordingly.

In 3G mode (i.e. UMTS radio access), the maximum output power cannot be set through the AT command, but is automatically set by the module according to the UE Maximum Power Reduction for the nominal maximum output power with HS-DPCCH and E-DCH defined by 3GPP specifications.

In 2G mode (i.e. GPRS and EDGE radio access), the maximum output power in GMSK or 8-PSK multi-slot configuration can be set by selecting the active multi-slot power reduction profile within the available profiles defined in Table 20 according to 3GPP specifications.

The maximum output power in GMSK or 8-PSK multislot configuration depends on the active MSPR profile set by the AT command and the number of active Tx slots set by the network, as described in Table 20:

| Active Tx slots | MSPR profile 0 | MSPR profile 1 | MSPR profile 2 | MSPR profile 3 |
|-----------------|----------------|----------------|----------------|----------------|
| 1 | 0 | 0 | 0 | 0 |
| 2 | 3 | 1 | 0 | 0 |
| 3 | 4,8 | 2,8 | 0,8 | 0 |
| 4 | 6 | 4 | 2 | 0 |

Table 20: Power reduction (dBm)



SARA-R422 / SARA-R422M8S / SARA-R422S
The changes in the user defined power reduction are effective after reboot.

14.5.2 Syntax

| Type | Syntax | Response | Example |
|------|--|---|---------------------------------------|
| Set | AT+UDCONF=40,<GMSK_profile>[,<8PSK_profile>] | OK | AT+UDCONF=40,2,3 OK |
| Read | AT+UDCONF=40 | +UDCONF: 40,<GMSK_profile>,<8PSK_profile> OK | AT+UDCONF=40 +UDCONF: 40,2,2 OK |

14.5.3 Defined values

| Parameter | Type | Description |
|----------------|--------|---|
| <GMSK_profile> | Number | User defined power reduction: MSPR GMSK profile (range 0-3). The factory-programmed value depends on the series module: <ul style="list-style-type: none"> SARA-R4 - 0 |
| <8PSK_profile> | Number | User defined power reduction: MSPR 8-PSK profile (range 0-3). This parameter is optional: if omitted, the MSPR 8-PSK profile is not affected. The factory-programmed value depends on the series module: <ul style="list-style-type: none"> SARA-R4 - 3. This parameter is mandatory |

14.5.4 Notes

- For AT&T certification: the 8-PSK MSPR profile should be limited to values 2 and 3.

SARA-R422 / SARA-R422M8S / SARA-R422S

- The **+UFACTORY** AT command cannot be used to restore the factory-programmed values.
- The GCF certification has been done using the factory-programmed values for both MSPR profiles. If a different couple of values is used, the same RF performance could be not guaranteed, when the maximum number of 4 UL slots are requested and modem works in HT or HV extreme conditions.

14.6 UART baud rate and flow control NVM management +UUARTCONF

| +UUARTCONF | | | | | | |
|------------|-----------------------------------|--------------|----------------|----------------|---------------|-----------------|
| Modules | SARA-R422 SARA-R422M8S SARA-R422S | | | | | |
| Attributes | Syntax | PIN required | Settings saved | Can be aborted | Response time | Error reference |
| | full | No | NVM | No | - | +CME Error |

14.6.1 Description

Stores the baud rate and flow control values to NVM (see the **+IPR** and **&K** AT commands) for the specified UART interface. The read command returns the NVM setting for all the available UART interfaces.

This command is intended to extend the possibility to have different stored values of **+IPR** and **&K** AT commands across the two UART interfaces.

- Setting in NVM for AUX UART interface is applied at boot regardless the **+USIO** configuration, that is AUX UART mode (AT, GNSS tunneling).
- The settings are saved immediately in NVM; the new configuration will be effective at the subsequent module reboot.

14.6.2 Syntax

| Type | Syntax | Response | Example |
|------|---|--|---|
| Set | AT+UUARTCONF=<uart_id>[,<rate>[,<fctrl>]] | OK | AT+UUARTCONF=1,115200,3 OK |
| Read | AT+UUARTCONF? | +UUARTCONF: <uart_id>,<rate>,<fctrl> [[..] +UUARTCONF: <uart_id>,<rate>,<fctrl> OK | +UUARTCONF: 0,115200,3 +UUARTCONF: 1,115200,3 OK |
| Test | AT+UUARTCONF=? | +UUARTCONF: (list of supported <uart_id>s),(list of fixed only supported <rate>s),(list of supported <fctrl>s) OK | +UUARTCONF: 1,(300,600,1200,2400,4800,9600,14400,19200,38400,57600,115200,230400,460800,921600,1000000,1200000,1500000,2000000,3000000),(0-3) OK |

14.6.3 Defined values

| Parameter | Type | Description |
|-----------|--------|---|
| <uart_id> | Number | UART identification code: <ul style="list-style-type: none"> 0: main UART identification code 1: auxiliary UART identification code  SARA-R422 / SARA-R422M8S / SARA-R422S Only <uart_id> = 1 is supported. |
| <rate> | Number | Allowed baud rates expressed in b/s (default and factory-programmed value is 115200) |
| <fctrl> | Number | DTE flow control mode (see the &K AT command): <ul style="list-style-type: none"> 0: disable DTE flow control 3 (default and factory-programmed value): enable the RTS/CTS DTE flow control |

14.7 Serial interfaces configuration selection +USIO

| +USIO | | | | | | |
|------------|-----------|--------------|----------------|----------------|---------------|-----------------|
| Modules | SARA-R422 | SARA-R422M8S | SARA-R422S | | | |
| Attributes | Syntax | PIN required | Settings saved | Can be aborted | Response time | Error reference |
| | full | No | NVM | No | - | +CME Error |

14.7.1 Description

Selects the serial interfaces' configuration.

The configuration affects how an available (either physical or logical) serial interface is used, i.e. the meaning of the data flowing over it. Possible usages are:

- Modem interface (AT command)
- Trace interface (diagnostic log)
- Raw interface (e.g. GPS/GNSS tunneling or SAP)
- Digital audio interface
- None

A set of configurations, that considers all the available serial interfaces' and their associated usage, is called +USIO's configuration variant.

 The serial interfaces' configuration switch is not performed run-time. The settings are saved in NVM; the new configuration will be effective at the subsequent module reboot.

 A serial interface might not support all the usages. For instance, UART cannot be used as digital audio interface.

14.7.2 Syntax

| Type | Syntax | Response | Example |
|------|-----------------------------|---|---|
| Set | AT+USIO=<requested_variant> | OK | AT+USIO=1 OK |
| Read | AT+USIO? | +USIO: <requested_variant>, *<active_variant> OK | +USIO: 1, *1 OK |
| Test | AT+USIO=? | +USIO: Variant=<requested_variant>: [AT=<AT_interface>;] [GNSS=<GNSS_interface>;] [TRACE=<Trace_interface>;] [DIGITAL AUDIO=<Digital_audio_interface>] [+USIO: Variant=<requested_variant>: [AT=<AT_interface>;][GNSS=<GNSS_interface>;][TRACE=<Trace_interface>;][DIGITAL AUDIO=<Digital_audio_interface>] [...]] OK | +USIO: Variant=0: AT="UART"; AT="AUX UART"; TRACE="EXT UART" +USIO: Variant=1: AT="UART"; TRACE="AUX UART"; DIGITAL AUDIO="I2S" +USIO: Variant=2: AT="UART"; AT="AUX UART"; DIGITAL AUDIO="I2S" +USIO: Variant=3: AT="UART"; GNSS="AUX UART"; TRACE="EXT UART" |

| Type | Syntax | Response | Example |
|------|--------|----------|---|
| | | | +USIO: Variant=4: AT="UART"; GNSS="AUX UART"; DIGITAL AUDIO="I2S" OK |

14.7.3 Defined values

| Parameter | Type | Description |
|---------------------------|--------|---|
| <requested_variant> | Number | Requested (stored in NVM for next boot) configuration variant (range 0-255). The factory-programmed value is 1. |
| <active_variant> | Number | Active (currently used) configuration variant (range 0-255). The factory-programmed value is 1. |
| <AT_interface> | String | Serial interface configured for AT commands |
| <GNSS_interface> | String | Serial interface configured for GNSS tunneling |
| <Trace_interface> | String | Serial interface configured for diagnostic log |
| <Digital_audio_interface> | String | Serial interface configured for digital audio |

14.7.4 Notes

- [Table 21](#) explains the meaning of <AT_interface>, <GNSS_interface>, <Trace_interface>, <Digital_audio_interface>.

**<AT_interface>, <GNSS_interface>, Serial interface description
<Trace_interface>, <Digital_audio_interface>**

| | |
|------------|---|
| "UART" | Main UART: It is the full featured UART (9-wire), used as main interface to the host. |
| "AUX UART" | Auxiliary UART: It is the general purpose UART (3-wire or 5-wire), with limited v.24 features. |
| "EXT UART" | External UART: It is not a real UART, but the SPI interface is used to communicate with an external chip providing SPI to UART conversion. Basically, it is limited to diagnostic log. |
| "USB" | USB CDC-ACM or Network over USB: USB CDC-ACM is a virtual UART, providing simulated v.24 features over a USB interface. Network over USB is a virtual network interface providing diagnostic logging. |
| "I2S" | I ² S interface: It can be used for the digital audio. See the Audio interface for the required configurations. |
| "SPI" | SPI interface: It is limited to diagnostic log. |
| "SDIO" | SDIO interface: It is limited to diagnostic log. |

Table 21: Serial interfaces

SARA-R422 / SARA-R422M8S / SARA-R422S

- The allowed configurations are listed as follows:

| <active_variant> | AT instance 1 | AT instance 2 | Diagnostic log | GNSS tunneling |
|------------------------------|---------------|-------------------|----------------|-------------------|
| 0 (factory-programmed value) | UART (9-wire) | Not available | USB | Not available |
| 1 | UART (5-wire) | AUX UART (5-wire) | USB | Not available |
| 4 | UART (5-wire) | Not available | USB | AUX UART (5-wire) |

Table 22: Supported USIO variants

- When the <active_variant> is 4, the AUX UART interface is configured as GNSS tunneling, its baud rate is fixed to 115200 b/s, regardless the previous value, and it cannot be modified.

SARA-R422

- <active_variant>=4 is not supported.

14.8 Internal temperature monitor +UTEMP

| +UTEMP | | | | | | |
|-------------------|---|---------------------|-----------------------|-----------------------|----------------------|------------------------|
| Modules | SARA-R410M-02B SARA-R410M-52B SARA-R410M-63B SARA-R410M-73B SARA-R410M-83B SARA-R412M SARA-R422 SARA-R422M8S SARA-R422S SARA-N4 | | | | | |
| Attributes | Syntax | PIN required | Settings saved | Can be aborted | Response time | Error reference |
| | partial | No | No | No | - | +CME Error |

14.8.1 Description

Returns the values of internal temperature sensors of the specified unit.

The command handling (sensors position and command syntax) depends on the module series:

- SARA-R4 / SARA-N4 - The AT command returns the value measured by the temperature sensor on the **Die**.

14.8.2 Syntax

| Type | Syntax | Response | Example |
|------|-----------------|--|---------------------|
| Set | AT+UTEMP=<unit> | OK | AT+UTEMP=0 OK |
| Read | AT+UTEMP? | +UTEMP: <die_temp>[,<unit>] OK | +UTEMP: 100,1 OK |
| Test | AT+UTEMP=? | +UTEMP: (list of supported <unit>) OK | +UTEMP: (0-1) OK |

14.8.3 Defined values

| Parameter | Type | Description |
|------------|--------|--|
| <unit> | Number | Select the measurement unit for value representation: <ul style="list-style-type: none"> 0: values in tenth of Celsius degrees returned 1: values in tenth of Fahrenheit degrees returned |
| <die_temp> | Number | Fetches value of Die temperature of the selected measurement unit; the allowed range depends on the measurement unit: <ul style="list-style-type: none"> Celsius degrees: [-40; 140] Fahrenheit degrees: [-40; 284] 655355: no valid temperature measure is available |

14.8.4 Notes

SARA-R410M-02B

- The command is not supported by SARA-R410M-02B-00.

SARA-R4 / SARA-N4

- The <unit> parameter is not provided in the information text response to the read command.

14.9 Restore factory configuration +UFACTORY

| +UFACTORY | | | | | | |
|-------------------|-----------------------------------|---------------------|-----------------------|-----------------------|----------------------|------------------------|
| Modules | SARA-R422 SARA-R422M8S SARA-R422S | | | | | |
| Attributes | Syntax | PIN required | Settings saved | Can be aborted | Response time | Error reference |
| | full | No | NVM | No | 5 s | +CME Error |

14.9.1 Description

Force, at the next module boot, the restore of the factory configuration for FS and/or NVM.

When the command is issued, a flag is written into the NVM: no action is done and it will be triggered to be executed only at the next module boot. If, before the next boot, the triggered operation must be deleted, then it is possible to issue the command with parameter 0,0.

14.9.2 Syntax

| Type | Syntax | Response | Example |
|------|------------------------------|---|------------------------------|
| Set | AT+UFACTORY=<fs_op>,<nvm_op> | OK | AT+UFACTORY=0,1 OK |
| Read | AT+UFACTORY? | +UFACTORY: <fs_op>,<nvm_op> OK | +UFACTORY: 0,1 OK |
| Test | AT+UFACTORY=? | +UFACTORY: (list of supported <fs_op>s),(list of supported <nvm_op>s) OK | +UFACTORY: (0-2),(0-2) OK |

14.9.3 Defined values

| Parameter | Type | Description |
|-----------|--------|--|
| <fs_op> | Number | FS factory restore type: <ul style="list-style-type: none"> 0 (factory-programmed value): no factory restore 1: see Notes 2: all files stored in FS deleted |
| <nvm_op> | Number | NVM factory restore type: <ul style="list-style-type: none"> 0 (factory-programmed value): no factory restore 1: NVM flash sectors erased 2: see Notes |

14.9.4 Notes

SARA-R422 / SARA-R422M8S / SARA-R422S

- <fs_op>=1 deletes all user files previously stored with "USER" tag.
- <fs_op>=2 is not supported.
- <nvm_op>=1 deletes all modem profiles.
- <nvm_op>=2 restores the UART interface and +UPSV AT command settings to the factory-programmed setting.
- After a <nvm_op>=1, it is required a second reboot in order to make the module again ready to properly accept and store new settings to NVM.

14.10 Backup and restore the file system +UBKUPDATA

| +UBKUPDATA | | | | | | |
|-------------------|---|---------------------|-----------------------|-----------------------|----------------------|------------------------|
| Modules | SARA-R410M-02B SARA-R412M SARA-R422 SARA-R422M8S SARA-R422S | | | | | |
| Attributes | Syntax | PIN required | Settings saved | Can be aborted | Response time | Error reference |
| | full | No | No | No | - | +CME Error |

14.10.1 Description

Backs up the file system. Upon receiving the action command and after the backup process is finished, the module performs a reboot. Upon a detection of a file system corruption, the module autonomously triggers a

restore of the last backup and immediately performs a reboot; it is possible to manually restore the last backup by means of the set command. If no backup has been performed, the factory-programmed file system image is restored.

The read command displays the backup and restore statistics. The +UUBKUPDATA URC notifies the result of the backup / restore operation.

14.10.2 Syntax

| Type | Syntax | Response | Example |
|--------|------------------------|---|---|
| Action | AT+UBKUPDATA | OK | OK |
| Set | AT+UBKUPDATA=<restore> | OK | AT+UBKUPDATA=r OK |
| Read | AT+UBKUPDATA? | +UBKUPDATA: <last_backup>, <last_restore>, <backup_number>, <restore_number>, <failed_op_type>, <last_failed_op>, <failure_code_location> | +UBKUPDATA: 172800,20,2,1,1,20 ,"file: fs_db.c, function: down_find, line: 1168" OK |
| URC | | +UUBKUPDATA: <op_type>, <result> | +UUBKUPDATA: 0,0 |

14.10.3 Defined values

| Parameter | Type | Description |
|-------------------------|--------|--|
| <restore> | String | Allowed value: <ul style="list-style-type: none"> r: triggers a restore operation The string is not enclosed within quotation marks. |
| <last_backup> | Number | Time in seconds elapsed since last backup operation |
| <last_restore> | Number | Time in seconds elapsed since last restore operation |
| <backup_number> | Number | Total number of backup operations performed |
| <restore_number> | Number | Total number of restored operations performed |
| <failed_op_type> | Number | Last failed operation type. Allowed values: <ul style="list-style-type: none"> 0: no operation failed 1: backup operation 2: restore operation |
| <last_failed_op> | Number | Time in seconds elapsed since last failed operation. If there are no failures (<failed_op_type>=0), value 0 is returned. |
| <failure_code_location> | String | Filename, function name and line number where the failure was triggered. If there are no failures, no indication regarding filename, function name and line number are provided. |
| <op_type> | Number | Operation type. Allowed values: <ul style="list-style-type: none"> 0: no operation 1: backup operation 2: restore operation |
| <result> | Number | Operation result. Allowed values: <ul style="list-style-type: none"> 0: operation failure 1: operation success 2: operation start |

14.10.4 Notes

SARA-R410M-02B / SARA-R412M

- The command is not supported by SARA-R410M-02B-00, SARA-R410M-02B-01, SARA-R410M-02B-02, SARA-R412M-02B-00, SARA-R412M-02B-01, SARA-R412M-02B-02.

SARA-R422 / SARA-R422M8S / SARA-R422S

- Only personalization data for security, calibrations and unique data will be restored; user files, parameters and profiles will be brought to the factory-programmed setting.

14.11 Cancel FOTA download +UFOTA

| +UFOTA | | | | | | |
|-------------------|--|---------------------|-----------------------|-----------------------|----------------------|----------------------------|
| Modules | SARA-R410M-02B SARA-R410M-63B SARA-R410M-73B SARA-R410M-83B SARA-R412M SARA-R422 SARA-R422M8S SARA-R422S | | | | | |
| Attributes | Syntax | PIN required | Settings saved | Can be aborted | Response time | Error reference |
| | full | Yes | No | No | - | +CME Error |

14.11.1 Description

Cancels the FW download to the device when a FOTA session is in progress. To make use of this command, enable URCs for FOTA sessions (for more details on enabling FOTA URCs, see [+UFOTASTAT](#) AT command).

The device does not reboot after cancelling FOTA download. At the next power-on, the module will boot the previous firmware version.

14.11.2 Syntax

| Type | Syntax | Response | Example |
|------|--------------------|-----------------|------------------|
| Set | AT+UFOTA=<op_code> | OK | AT+UFOTA=0 OK |
| Test | AT+UFOTA=? | +UFOTA: 0 OK | +UFOTA: 0 OK |

14.11.3 Defined values

| Parameter | Type | Description |
|-----------|--------|---|
| <op_code> | Number | Allowed value: <ul style="list-style-type: none"> 0: abort FOTA download |

14.11.4 Notes

SARA-R410M / SARA-R412M

- In case of error only the "ERROR" final result code is returned.

SARA-R410M-02B / SARA-R412M

- The command is not supported by SARA-R410M-02B-00, SARA-R410M-02B-01, SARA-R410M-02B-02, SARA-R412M-02B-00, SARA-R412M-02B-01, SARA-R412M-02B-02.

14.12 Sets FOTA status URCs +UFOTASTAT

| +UFOTASTAT | | | | | | |
|-------------------|--|---------------------|-----------------------|-----------------------|----------------------|----------------------------|
| Modules | SARA-R410M-02B SARA-R410M-63B SARA-R410M-73B SARA-R410M-83B SARA-R412M SARA-R422 SARA-R422M8S SARA-R422S | | | | | |
| Attributes | Syntax | PIN required | Settings saved | Can be aborted | Response time | Error reference |
| | full | No | NVM | No | - | +CME Error |

14.12.1 Description

Enables URC reporting status for FOTA downloads and updates.

14.12.2 Syntax

| Type | Syntax | Response | Example |
|------|------------------|---|-------------------------|
| Set | AT+UFOTASTAT=<n> | OK | AT+UFOTASTAT=1 OK |
| Read | AT+UFOTASTAT? | +UFOTASTAT: <n> OK | +UFOTASTAT: 1 OK |
| Test | AT+UFOTASTAT=? | +UFOTASTAT: (list of supported<n>s) OK | +UFOTASTAT: (0,1) OK |

| Type | Syntax | Response | Example |
|----------------------------|--------|--|---------------------------|
| | | OK | |
| Generic syntax | | | |
| URC | | +UFOTASTAT: <event>,<param1>[, <param2>] | +UFOTASTAT: 3,1,0 OK |
| | | OK | |
| Download progress | | | |
| URC | | +UFOTASTAT: 0,<progress_status>[,<percentage>] | +UFOTASTAT: 0,1,10 OK |
| | | OK | |
| Download start | | | |
| URC | | +UFOTASTAT: 1,<start_triggered>, 0 | +UFOTASTAT: 1,0,0 OK |
| | | OK | |
| Download complete | | | |
| URC | | +UFOTASTAT: 2,<status>,<status_details> | +UFOTASTAT: 2,2,100 OK |
| | | OK | |
| FOTA status | | | |
| URC | | +UFOTASTAT: 3,<update_result>,<update_state> | +UFOTASTAT: 3,1,0 OK |
| | | OK | |
| Registration status | | | |
| URC | | +UFOTASTAT: 4,<registration_result> | +UFOTASTAT: 4,2 OK |
| | | OK | |

14.12.3 Defined values

| Parameter | Type | Description |
|-------------------|--------|--|
| <n> | Number | Enable FOTA status URCs: <ul style="list-style-type: none"> 0: FOTA status URC disabled 1 (factory-programmed value): FOTA status +UFOTASTAT URC enabled |
| <event> | Number | Event type: <ul style="list-style-type: none"> 0: download progress 1: download start 2: download complete 3: FOTA status 4: registration status Allowed values: <ul style="list-style-type: none"> SARA-R4 - 0, 1, 2, 3 |
| <progress_status> | Number | Allowed value: <ul style="list-style-type: none"> 1: download in progress |
| <percentage> | Number | Download completion in percentage |
| <start_triggered> | Number | Allowed value: <ul style="list-style-type: none"> 0: download start triggered |
| <status> | Number | FOTA completed download status: <ul style="list-style-type: none"> 2: success 3: fail |
| <status_details> | Number | Provides more information about FOTA completed download status: <ul style="list-style-type: none"> 100: success if <status>=2 100: user cancel if <status>=3 101: memory error 102: network error 103: unknown error 104: bad url 105: failure due to connectivity loss |

| Parameter | Type | Description |
|-----------------------|--------|---|
| <update_result> | Number | Provides more information about FOTA completed download status: <ul style="list-style-type: none"> • 0: initial • 1: success • 2: memory error • 3: RAM error • 4: connection lost • 5: checksum error • 6: unsupported package • 7: URI error • 8: firmware update fail • 9: unsupported protocol • 100: user abort |
| <update_state> | Number | Provides more information about FOTA completed download status: <ul style="list-style-type: none"> • 0: idle • 1: downloading • 2: downloaded • 3: updating |
| <registration_result> | Number | Provides more information about registration status: <ul style="list-style-type: none"> • 0: idle • 1: bootstrap started • 2: bootstrap successful • 3: bootstrap failed • 4: connect successful • 5: connect failed • 6: registration successful • 7: registration failed • 8: registration timeout • 9: client life time timeout • 10: client halted • 11: update successful • 12: update failed • 13: update timeout • 14: response failed • 15: notify failed • 16: deregistration successful • 17: deregistration failed |
| <param1> | Number | Contains additional information depending on <event> value. |
| <param2> | Number | Contains additional information depending on <event> and <param1> values. |

14.12.4 Notes

SARA-R422 / SARA-R422M8S / SARA-R422S

- In case of error only the "ERROR" final result code is returned.
- The <n> factory-programmed value is 0 (FOTA status +UFOTASTAT URC disabled).

SARA-R410M / SARA-R412M

- In case of error only the "ERROR" final result code is returned.
- <status_details>=105 (failure due to connectivity loss) is not supported.

SARA-R410M-02B / SARA-R412M

- The command is not supported by SARA-R410M-02B-00, SARA-R410M-02B-01, SARA-R410M-02B-02, SARA-R412M-02B-00, SARA-R412M-02B-01, SARA-R412M-02B-02.
- The <n> factory-programmed value is 0 (FOTA status +UFOTASTAT URC disabled).

14.13 uFOTA configuration +UFOTACONF

| +UFOTACONF | | | | | | |
|-------------------|---|---------------------|-----------------------|-----------------------|----------------------|------------------------|
| Modules | SARA-R410M-02B SARA-R410M-52B SARA-R412M SARA-N4 | | | | | |
| Attributes | Syntax | PIN required | Settings saved | Can be aborted | Response time | Error reference |
| | full | No | NVM | No | - | +CME Error |

14.13.1 Description

Configures the uFOTA registration and timer for periodic connections to the uFOTA server.

14.13.2 Syntax

| Type | Syntax | Response | Example |
|----------------------------------|---|--|---|
| Generic syntax | | | |
| Set | AT+UFOTACONF=<mode>, <param>[,<param1>] | OK | AT+UFOTACONF=2,604800 OK |
| uFOTA server address | | | |
| Set | AT+UFOTACONF=0,<hostname>[, <remote_port>] | OK | AT+UFOTACONF=0,"leshan.com" OK |
| uFOTA registration | | | |
| Set | AT+UFOTACONF=1,<registration> | OK | AT+UFOTACONF=1,1 OK |
| uFOTA periodic connection | | | |
| Set | AT+UFOTACONF=2,<timer> | OK | AT+UFOTACONF=2,604800 OK |
| uFOTA retry timer | | | |
| Set | AT+UFOTACONF=3,<retry_timer> | OK | AT+UFOTACONF=3,120 OK |
| Read | AT+UFOTACONF=<mode> | +UFOTACONF: <mode>,<param> OK | +UFOTACONF: 1,1 OK |
| Test | AT+UFOTACONF=? | +UFOTACONF: (list of supported <mode>s),(list of supported <timer>s) OK | +UFOTACONF: (0-3),(-1,1- 4294967295) OK |

14.13.3 Defined values

| Parameter | Type | Description |
|----------------|--------|--|
| <mode> | Number | uFOTA parameter to be configured: <ul style="list-style-type: none"> 0: address of uFOTA server 1: module registration to uFOTA server 2: timer for periodic connection to the uFOTA server 3: retry timer for periodic connection to the uFOTA server |
| <hostname> | String | Hostname of the FOTA server. The maximum length is 128 characters. The factory-programmed value is the empty string. |
| <remote_port> | Number | Remote port of the FOTA server. The range goes from 1 to 65535. The default and factory-programmed value is: <ul style="list-style-type: none"> 5683 if DTLS is disabled 5684 if DTLS is enabled |
| <registration> | Number | uFOTA registration: <ul style="list-style-type: none"> 0: module registration to uFOTA server disabled 1 (factory-programmed and default value): module registration to uFOTA server enabled |
| <timer> | Number | Timer for periodic connection to the uFOTA server (in seconds); the factory-programmed and default value is 604800 (7 days): <ul style="list-style-type: none"> If <timer>=-1 or 0 the module never periodically connects to the uFOTA server |

| Parameter | Type | Description |
|---------------|-----------------|---|
| | | <ul style="list-style-type: none"> 1-4294967295: range in seconds for periodic connections |
| <retry_timer> | Number | Timer for periodic connection to the uFOTA server expressed in seconds; the allowed range is 0-86400. The factory-programmed value is 60. |
| <param> | Number / String | Type and supported content depend on the related <op_code> parameter; details are given above |
| <param1> | Number / String | Type and supported content depend on the related <op_code> parameter; details are given above |

14.13.4 Notes

SARA-R4 / SARA-N4

- <mode> = 1 is not supported. Disable the uFOTA registration by means of <mode> = 2 and <timer> = -1.
- Upon boot-up, the set and read commands will provide an error result code until the LwM2M application is ready which can take up to 45 s.
- The <mode> = 0 and 3 are not supported.

SARA-R410M-02B / SARA-R412M

- The command is not supported by SARA-R410M-02B-00, SARA-R410M-02B-03 and SARA-R412M-02B-03.

14.14 Last gasp configuration +ULGASP

| +ULGASP | | | | | | |
|-------------------|---|---------------------|-----------------------|-----------------------|----------------------|------------------------|
| Modules | SARA-R410M-02B SARA-R410M-52B SARA-R410M-63B SARA-R410M-73B SARA-R410M-83B SARA-R412M SARA-R422M8S SARA-R422S SARA-N4 | | | | | |
| Attributes | Syntax | PIN required | Settings saved | Can be aborted | Response time | Error reference |
| | partial | No | NVM | No | < 10 s | +CME Error |

14.14.1 Description

Enables/disables and configures the last gasp feature. The application is automatically triggered by a properly configured GPIO (see [GPIO introduction](#), <gpio_mode>=19). The feature supports the sending of a predefined last notification in case of power outage, just before the power goes off. It is assumed that the cellular module is registered to the network when the alarm is triggered; however the command just configures the feature so it is possible to issue it also if PIN is not inserted. It is possible to enable/disable the +UULGASP URC to be notified about the operation result.

This AT command must be issued after a proper configuration of the GPIO pin via the +UGPIOC command, <gpio_mode>=19. Otherwise, if +UGPIOC is issued after +ULGASP, the last gasp will work only after a reboot.

The parameters will be set to the values stored in the NVM in case they are omitted in the set command.

14.14.2 Syntax

| Type | Syntax | Response | Example |
|------|---|---|--|
| Set | AT+ULGASP=<GPIO_mode>, <text>,<msg_format>,,<profile_id>, <IP_protocol>,<IP_addr:PORT>[, [<method>],,<urc_enable>],[<nv_ upd_freq>],[<tx_count>]] | OK | AT+ULGASP=0,"Power_loss",0,,1,17, "192.168.100.20:8080" OK |
| Read | AT+ULGASP? | +ULGASP: <GPIO_mode>,<text>, <msg_format>,,<profile_ID>, <IP_protocol>,<IP_addr:PORT>, <method>,,<urc_enable>,<nv_upd_ freq>,<tx_count> OK | +ULGASP: 0,"Power_loss",0,,1,17, "192.168.100.20:8080",1,,1,0,1 OK |
| Test | AT+ULGASP=? | +ULGASP: (list of supported <GPIO_ mode>'s),,(list of supported <msg_ format>'s),,(list of supported | +ULGASP: (0-2),,(0-1),,(1),(17),,(1),,(0-1),,(0-3600),(1-10) OK |

| Type | Syntax | Response | Example |
|------|--------|--|---------------|
| | | <profile_id>'s),(list of supported <IP_protocol>'s),(list of supported <method>'s),(list of supported < urc_enable>'s),(list of supported <nv_upd_freq>'s),(list of supported <tx_count>'s) OK | |
| URC | | +UULGASP: <result>,<bearer> | +UULGASP: 0,1 |

14.14.3 Defined values

| Parameter | Type | Description |
|----------------|--------|--|
| <GPIO_mode> | Number | Select the interrupt trigger. Allowed values: <ul style="list-style-type: none"> • 0 (factory-programmed value): trigger disabled; the following arguments will be ignored. • 1: falling edge • 2: rising edge |
| <text> | String | The string that will be sent upon GPIO movement. Text or binary format can be selected with the <msg_format> parameter. When text format is selected, a maximum of 256 ASCII characters is allowed. When the binary format is selected, a maximum of 512 characters (0-9,A-F) is allowed. Every 8-bit octet of the message must be written as two IRA character long hexadecimal numbers, e.g. an octet with integer value 42 (i.e. 0x2A) must be written as a string of two characters "2A" (IRA 50 and 65). Factory-programmed value: empty string. |
| <msg_format> | Number | Format of the <text> parameter. Allowed values: <ul style="list-style-type: none"> • 0 (factory-programmed value): text • 1: binary |
| <profile_id> | Number | PSD profile identifier. The active external context is used and the value is ignored. Only the value 1 is allowed. |
| <IP_protocol> | Number | IP protocol used for socket connection. Allowed values: <ul style="list-style-type: none"> • 17: UDP |
| <IP_addr:PORT> | String | IPv4 server address with the socket port. Factory-programmed value: empty string. |
| <method> | Number | Notification method, it is the way the application send out the <text message>. Allowed values: <ul style="list-style-type: none"> • 1: use UDP/IP connection |
| <urc_enable> | Number | Flag determining if the URC is to be issued or not. Allowed values: <ul style="list-style-type: none"> • 0: disabled • 1 (factory-programmed value): enabled |
| <result> | Number | Operation result. Allowed values: <ul style="list-style-type: none"> • 0: success • 1: generic fail |
| <bearer> | Number | Notification used bearer. Allowed values: <ul style="list-style-type: none"> • 1: UDP/IP connection |
| <nv_upd_freq> | Number | NVM update frequency in seconds. Valid range of 0-3600 s indicating how frequently to flush the settings to NVM. A zero value indicates that settings should never be saved to NVM, otherwise the following settings will be saved to NVM based on the timer: <GPIO_mode>, <text>, <IP_addr:PORT>, <urc_enable>, <tx_count>. Factory-programmed value: 60. |
| <tx_count> | Number | Indicates the number of times to transmit the last gasp message. Valid range is 1-10. Factory-programmed value: 1. |

14.14.4 Notes

SARA-R4 / SARA-N4

- The <urc_enable>, <nv_upd_freq>, <tx_count> parameters will return 0, 0 and 0 if read for the first time before setting the mandatory last gasp parameters. Once the mandatory last gasp parameters are set, these values take on the factory-programmed values.
- The module is switched off once the last gasp procedure is completed.

SARA-R410M-02B

- The command is not supported by SARA-R410M-02B-00.

SARA-R422M8S / SARA-R422S

- When the trigger is disabled (<GPIO_mode>=0), the GPIO pin will remain in its current state (input pull-up or pull-down) until the interrupt trigger is enabled again (<GPIO_mode>=1 or 2).

14.15 RING line configuration +URINGCFG

| +URINGCFG | | | | | | |
|-------------------|---|---------------------|-----------------------|-----------------------|----------------------|------------------------|
| Modules | SARA-R410M-02B SARA-R410M-52B SARA-R410M-63B SARA-R410M-73B SARA-R410M-83B SARA-R412M SARA-R422 SARA-R422M8S SARA-R422S SARA-N4 | | | | | |
| Attributes | Syntax | PIN required | Settings saved | Can be aborted | Response time | Error reference |
| | full | No | NVM | No | - | +CME Error |

14.15.1 Description

Configures the RING line of the UART interface for events such as the incoming SMS indication and incoming data. This command is independent of the URC setting for SMS.

The RING line will be asserted when one of the configured events occurs and it remains asserted for 1 s unless another configured event happens (in this case the 1 s timer will be started again).

14.15.2 Syntax

| Type | Syntax | Response | Example |
|------|--------------------|--|------------------------|
| Set | AT+URINGCFG=<mode> | OK | AT+URINGCFG=1 OK |
| Read | AT+URINGCFG? | +URINGCFG: <mode> OK | +URINGCFG: 1 OK |
| Test | AT+URINGCFG=? | +URINGCFG: (list of the supported <mode>s) OK | +URINGCFG: (0-3) OK |

14.15.3 Defined values

| Parameter | Type | Description |
|-----------|--------|---|
| <mode> | Number | Configures the RING line handling: <ul style="list-style-type: none"> • 0 (factory-programmed value): feature disabled • 1: RING line asserted for incoming SMS • 2: RING line asserted for all the incoming data (PPP, sockets, FTP in Direct Link mode) • 3: RING line asserted for both incoming SMS and all incoming data (PPP, sockets, FTP in Direct Link mode) |

14.15.4 Notes

- Configure the UART Ring Indicator (RI) line for the ring indication by means of the +UGPIOC AT command, <gpio_mode>=18.

SARA-R410M-02B

- The command is not supported by SARA-R410M-02B-00.

SARA-R422 / SARA-R422M8S / SARA-R422S

- If +USIO: 1 it is not possible to enable the URINGCFG feature.
- If +USIO: 1 is set when URINGCFG is enabled, at the module reboot the URINGCFG feature will be disabled forcing the <mode> parameter to 0.

15 Power management

15.1 Power saving control (Power SaVing) +UPSV

| +UPSV | | | | | | |
|-------------------|---|---------------------|-------------------------|-----------------------|----------------------|----------------------------|
| Modules | SARA-R410M-02B SARA-R410M-52B SARA-R410M-63B SARA-R410M-73B SARA-R410M-83B SARA-R412M SARA-R422 SARA-R422M8S SARA-R422S SARA-N4 | | | | | |
| Attributes | Syntax | PIN required | Settings saved | Can be aborted | Response time | Error reference |
| | partial | No | Profile | No | - | +CME Error |

15.1.1 Description



Sets the UART power saving configuration, but it has a global effect on the module power saving configuration:

- If the power saving is disabled (+UPSV: 0), the UART interface is always enabled and the module does not enter the idle mode
- If the power saving is controlled by the UART **DTR** line (+UPSV: 3), the UART interface is enabled and the module does not enter idle mode as long as the UART **DTR** line state is ON
- If the power saving is enabled (+UPSV: 4), the UART interface is disabled after 6 s of inactivity and the module enters the idle mode automatically whenever possible

15.1.2 Syntax

| Type | Syntax | Response | Example |
|------|----------------|--|--------------------|
| Set | AT+UPSV=<mode> | OK | AT+UPSV=4 OK |
| Read | AT+UPSV? | +UPSV: <mode> OK | +UPSV: 0 OK |
| Test | AT+UPSV=? | +UPSV: (list of supported <mode>s) OK | +UPSV: (0,4) OK |

15.1.3 Defined values

| Parameter | Type | Description |
|-----------|--------|--|
| <mode> | Number | Power saving configurations: <ul style="list-style-type: none"> • 0: (default and factory-programmed value): power saving disabled • 3: power saving is controlled by the UART DTR line activity <ul style="list-style-type: none"> ◦ If the DTR line state is set to OFF, the power saving is allowed ◦ If the DTR line state is set to ON, the module shall exit from power saving  <mode>=3 is allowed regardless the flow control setting on the UART interface. In particular, the HW flow control can be set on UART during this mode.  With <mode>=3 the DTE can start sending data to the module without risk of data loss after having asserted the UART DTR line (DTR line set to ON state). <ul style="list-style-type: none"> • 4: power saving is controlled by the UART TX line activity Allowed values: <ul style="list-style-type: none"> • SARA-R410M / SARA-R412M / SARA-N4 - 0, 4 • SARA-R422 / SARA-R422M8S / SARA-R422S - 0, 3, 4 |

15.1.4 Notes

- For a detailed explanation of modules' operating modes, modules and interfaces behavior in reference to the +UPSV command setting, see the corresponding system integration manual.

SARA-R4 / SARA-N4

- The command setting is stored in the NVM.

SARA-R410M-02B

- The command is not supported by SARA-R410M-02B-00.

15.2 Power Saving Mode Setting +CPSMS

| +CPSMS | | | | | | |
|------------|--------------|--------------|----------------|----------------|---------------|-----------------|
| Modules | All products | | | | | |
| Attributes | Syntax | PIN required | Settings saved | Can be aborted | Response time | Error reference |
| | partial | Yes | NVM / OP | No | < 10 s | +CME Error |

15.2.1 Description

Controls the setting of the UEs Power Saving Mode (PSM) parameters. The command controls whether the UE wants to apply PSM or not, as well as:

- the requested extended periodic RAU value in GERAN/UTRAN
- the requested GPRS READY timer value in GERAN/UTRAN
- the requested extended periodic TAU value in E-UTRAN
- the requested Active Time value.



SARA-R4 / SARA-N4

Do not use a PIN enabled SIM card, otherwise the module does not enter PSM.

The read command returns the requested values:

- If the Power Saving Mode is enabled (+CPSMS: 1) and granted by the network (+UCPSMS: 1), i.e. Active Time has been assigned, after the expiry of the assigned Active Time (T3324), every SW and HW component on the device will power down except for the real time clock (RTC). It will stay powered down until the expiry of the assigned extended periodic TAU value (T3412_ext) or the assigned periodic TAU value (T3412) (if the former has not been assigned) or the power on line is toggled.
- If the Power Saving Mode is disabled (+CPSMS: 0) or not granted by the network (+UCPSMS: 0) the device will not enter Power Saving Mode (PSM).

Check whether the Active Time and the extended periodic TAU have been assigned to the UE by means of the [AT+CEREG=4](#) command.



SARA-R410M / SARA-R412M / SARA-R422 / SARA-R422M8S / SARA-R422S / SARA-N4

The assigned Active Time, extended periodic TAU value and periodic TAU value can be checked by means of the [+UCPSMS](#) AT command.



SARA-R4 / SARA-N4

To change the command setting issue [AT+COPS=2](#) or [AT+CFUN=0](#) to deregister the module from network, issue the +CPSMS command and reboot (e.g. by means of the [AT+CFUN=15](#) command) the module in order to apply the new configuration.



SARA-R410M-02B / SARA-R410M-52B / SARA-R410M-63B / SARA-R410M-73B / SARA-R410M-83B / SARA-R412M

If the Power Saving Mode is enabled (+CPSMS: 1) and not granted by the network, the device enters the non-network-coordinated PSM. For more details about disabling PSM without network coordination, see the [+UPSMVER](#) AT command.



SARA-R4

If the set command is issued and an optional parameter is omitted, the module applies the last set value.

15.2.2 Syntax

| Type | Syntax | Response | Example |
|------|---|---|--|
| Set | AT+CPSMS=[<mode>[, <Requested_Periodic_RAU>[, <Requested_GPRS_READY_timer>[, <Requested_Periodic_TAU>[, [<Requested_Active_Time>]]]]] | OK | AT+CPSMS=1,,,"01000011","01000011" OK |
| Read | AT+CPSMS? | +CPSMS: <mode>,[<Requested_Periodic_RAU>],[<Requested_GPRS_READY_timer>], | +CPSMS: 1,,,"01000011","01000011" OK |

| Type | Syntax | Response | Example |
|------|------------|--|--|
| | | [<Requested_Periodic_TAU>], [<Requested_Active_Time>] OK | |
| Test | AT+CPSMS=? | +CPSMS: (list of supported <mode>s),(list of supported <Requested_Periodic_RAU>s),(list of supported <Requested_GPRS_READY_timer>s),(list of supported <Requested_Periodic_TAU>s),(list of supported <Requested_Active_Time>s) OK | +CPSMS: (0,1,2),,,"00000000"- "11111111"),("00000000"- "11111111") OK |

15.2.3 Defined values

| Parameter | Type | Description |
|------------------------------|--------|--|
| <mode> | Number | Indication to disable or enable the use of PSM in the UE. Allowed values: <ul style="list-style-type: none"> 0 (default value): disable the use of PSM 1: enable the use of PSM 2: disable the use of PSM and reset all parameters for PSM to factory-programmed values. The factory-programmed value is: <ul style="list-style-type: none"> SARA-R4 / SARA-N4 - 0 |
| <Requested_Periodic_RAU> | String | One byte in an 8 bit format. Requested extended periodic RAU value (T3312_ext) to be allocated to the UE in GERAN/UTRAN. The requested extended periodic RAU value is coded as one byte (octet 3) of the GPRS Timer 3 information element coded as bit format (e.g. "01000111" equals 70 hours). For the coding and the value range, see the GPRS Timer 3 IE in 3GPP TS 24.008 table 10.5.163a/3GPP TS 24.008 [67]. See also 3GPP TS 23.682 [67]. See also 3GPP TS 23.682 [142] and 3GPP TS 23.060 [65]. The factory-programmed value is: <ul style="list-style-type: none"> SARA-R422 / SARA-R422M8S / SARA-R422S - "00111000" (24 hours) SARA-R412M - "00011000" (4 hours) |
| <Requested_GPRS_READY_timer> | String | One byte in an 8 bit format. Requested GPRS READY timer value (T3314) to be allocated to the UE in GERAN/UTRAN. The requested GPRS READY timer value is coded as one byte (octet 2) of the GPRS Timer information element coded as bit format (e.g. "01000011" equals 3 decihours or 18 minutes). For the coding and the value range, see the GPRS Timer IE in 3GPP TS 24.008 table 10.5.172/3GPP TS 24.008 [67]. See also 3GPP TS 23.060 [65]. The factory-programmed value is "00001010" (20 s). |
| <Requested_Periodic_TAU> | String | One byte in an 8 bit format. Requested extended periodic TAU value (T3412_ext) to be allocated to the UE in E-UTRAN. The requested extended periodic TAU value is coded as one byte (octet 3) of the GPRS Timer 3 information element coded as bit format (e.g. "01000111" equals 70 hours). For the coding and value range, see the GPRS Timer 3 IE in 3GPP TS 24.008 table 10.5.163a/3GPP TS 24.008 [67]. See also 3GPP TS 23.682 [142] and 3GPP TS 23.401 [143]. <ul style="list-style-type: none"> SARA-R410M-02B / SARA-R410M-52B / SARA-R410M-63B / SARA-R410M-73B / SARA-R410M-83B / SARA-R412M - For the factory-programmed value, see Mobile Network Operator profiles. SARA-R422 / SARA-R422M8S / SARA-R422S - The factory-programmed value is "00111000" (24 hours). SARA-R404M / SARA-R410M-01B / SARA-N4 - The factory-programmed value is "1000101" (150 s). The default value is "01100000" (0 s). |
| <Requested_Active_Time> | String | One byte in an 8 bit format. Requested Active Time value (T3324) to be allocated to the UE in GERAN/UTRAN or in EUTRAN. The requested Active Time value is coded as one byte (octet 3) of the GPRS Timer 2 information element coded as bit format (e.g. "00100100" equals 4 minutes). For the coding and value range, see the GPRS Timer 2 IE in 3GPP TS 24.008 table 10.5.163/3GPP TS 24.008 [67]. See also 3GPP TS 23.682 [142], 3GPP TS 23.060 [65] and 3GPP TS 23.401 [143]. <ul style="list-style-type: none"> SARA-R410M-02B / SARA-R410M-52B / SARA-R410M-63B / SARA-R410M-73B / SARA-R410M-83B / SARA-R412M - For the factory-programmed value, see Mobile Network Operator profiles. |

| Parameter | Type | Description |
|-----------|------|--|
| | | <ul style="list-style-type: none"> SARA-R422 / SARA-R422M8S / SARA-R422S - The factory-programmed value is "0001010" (20 s). SARA-R404M / SARA-R410M-01B / SARA-N4 - The factory-programmed value is "0000011" (6 s). The default value is "00000000" (0 s). |

15.2.4 Notes

SARA-R4 / SARA-N4

- <mode>=2 (PSM use disabled and reset all parameters for PSM to factory-programmed values) is not supported. To reset all the PSM parameters to factory-programmed values, follow the procedure described in the [+UMNOPROF](#) AT command description.
- The module converts the <Requested_Periodic_RAU>, <Requested_GPRS_READY_timer>, <Requested_Periodic_TAU>, <Requested_Active_Time> parameters bitmasks configured with the set command to equivalent ones which represent the same value. The new bitmasks use the smallest unit of measurement possible to represent the timer value. See [Table 23](#) for additional examples.

| Command | Response | Description |
|------------------------------------|---|--|
| AT+CPSMS=1,,,"00000010","00000010" | OK | Set <Requested_Periodic_TAU> to "00000010" corresponding to 20 minutes (=10 minutes * 2) |
| AT+CPSMS? | +CPSMS: 1,,,"10110100","00000010" OK | Check the <Requested_Periodic_TAU> parameter value. The <Requested_Periodic_TAU> bitmask is converted to "10110100" that corresponds to 1 minute * 20 (= 20 minutes) |
| AT+CPSMS=1,,,"00000001","00000001" | OK | Set <Requested_Periodic_TAU> to "00000001" corresponding to 10 minutes (=10 minutes * 1) |
| AT+CPSMS? | +CPSMS: 1,,,"10010100","00000001" OK | Check the <Requested_Periodic_TAU> parameter value. The <Requested_Periodic_TAU> bitmask is converted to "10010100" that corresponds to 30 seconds * 20 (= 10 minutes) |

Table 23: <Requested_Periodic_TAU> bitmask conversion examples

SARA-R422 / SARA-R422M8S / SARA-R422S

- To reset all the PSM parameters to their factory-programmed values, the special command AT+CPSMS= (with all parameters omitted) can also be issued.
- If [+UPSMVER: 8](#) (PSM is not being requested to the network), the <Requested_Periodic_TAU> and the <Requested_Active_Time> parameters are displayed as 0 (previously configured values are preserved, visualized and used when re-enabling PSM deep-sleep).
- If <mode>=0 (PSM is not being requested to the network), the <Requested_Periodic_TAU>, <Requested_Active_Time>, <Requested_Periodic_RAU> and <Requested_GPRS_READY_timer> parameters are displayed as 0 (previously configured values are preserved, visualized and used when re-enabling PSM).

SARA-R410M-63B / SARA-R410M-73B / SARA-R410M-83B

- If the special command AT+CPSMS= (with all parameters omitted) is issued, the use of PSM is disabled (<mode>=0) and all the PSM parameters are set to the following values:
 - <Requested_Periodic_TAU>="00011000" (4 hours)
 - <Requested_Active_Time>="00001010" (20 s)
- If <mode>=0 (PSM is not being requested to the network), the <Requested_Periodic_TAU> and the <Requested_Active_Time> parameters are displayed as 0 (values are preserved, visualized and used when re-enabling PSM).
- If [+UPSMVER: 1](#) or [+UPSMVER: 8](#) or [+UPSMVER: 9](#) (PSM is not being requested to the network), the <Requested_Periodic_TAU> and the <Requested_Active_Time> parameters are displayed as 0 (values are preserved, visualized and used when re-enabling PSM).

SARA-R404M / SARA-R410M / SARA-N4

- The <Requested_Periodic_RAU> and <Requested_GPRS_READY_timer> parameters are not supported.
- The test command response is +CPSMS: (0-1),(<Units(0-6)><TimerValue(0-31)> in bits),(<Units(0-2)><TimerValue(0-31)> in bits),(<Units(0-6)><TimerValue(0-31)> in bits),(<Units(0-2)><TimerValue(0-31)> in bits).

SARA-R412M

- The test command response is +CPSMS: (0-1),(<Units(0-6)><TimerValue(0-31)> in bits),(<Units(0-2)><TimerValue(0-31)> in bits),(<Units(0-6)><TimerValue(0-31)> in bits),(<Units(0-2)><TimerValue(0-31)> in bits).

SARA-R410M-02B / SARA-R410M-52B / SARA-R412M / SARA-N4

- The <mode>, <Requested_Periodic_TAU> and <Requested_Active_Time> parameters are mandatory.
- If <mode>=0 (PSM is not being requested to the network), the <Requested_Periodic_TAU> and the <Requested_Active_Time> parameters are displayed as 0 (values are preserved, visualized and used when re-enabling PSM).
- If +UPSMVER: 1 or +UPSMVER: 8 or +UPSMVER: 9 (PSM is not being requested to the network), the <Requested_Periodic_TAU> and the <Requested_Active_Time> parameters are displayed as 0 (values are preserved, visualized and used when re-enabling PSM).

15.3 Power Saving Mode assigned values +UCPSMS

| +UCPSMS | | | | | | |
|------------|--|--------------|----------------|----------------|---------------|-----------------|
| Modules | SARA-R410M SARA-R412M SARA-R422 SARA-R422M8S SARA-R422S SARA-N4 | | | | | |
| Attributes | Syntax | PIN required | Settings saved | Can be aborted | Response time | Error reference |
| | full | No | No | No | - | +CME Error |

15.3.1 Description

Reads the UEs Power Saving Mode (PSM) parameters assigned by the network. The command returns the information about whether PSM is granted by the network and in case it is it also provides:

- the assigned extended periodic RAU value in GERAN/UTRAN if present
- the assigned GPRS READY timer value in GERAN/UTRAN if present
- the assigned extended periodic TAU value in E-UTRAN or assigned periodic TAU value (if the former is not present)
- the assigned Active Time value.

To be noticed that:

- If Power Saving Mode is granted by the network (+UCPSMS: 1), after the expiry of the assigned Active Time (T3324), every SW and HW component on the device will power down except the real time clock (RTC). It will stay powered down until the expiry of the assigned extended periodic TAU value (T3412_ext) or assigned periodic TAU value (T3412) (if the former is not present) or the power on line is toggled.
- If Power Saving Mode is not granted by the network (+UCPSMS: 0), the device will not enter Power Saving Mode (PSM).



SARA-R410M-02B / SARA-R410M-52B / SARA-R410M-63B / SARA-R410M-73B / SARA-R410M-83B / SARA-R412M

If the Power Saving Mode is enabled (+CPSMS: 1) and not granted by the network, the device enters the non-network-coordinated PSM. For more details about disabling PSM without network coordination, see the +UPSMVER AT command.

15.3.2 Syntax

| Type | Syntax | Response | Example |
|------|------------|--|---|
| Read | AT+UCPSMS? | +UCPSMS: <mode>,[<Assigned_Periodic_RAU>],[<Assigned_GPRS_READY_timer>],[<Assigned_Periodic_TAU>],[<Assigned_Active_ | +UCPSMS: 1,,,"01000011","0100011",1 OK |

| Type | Syntax | Response | Example |
|------|--------|--|---------|
| | | Time>],[<Assigned_Periodic_TAU_Format_Type>] OK | |

15.3.3 Defined values

| Parameter | Type | Description |
|-------------------------------------|--------|---|
| <mode> | Number | State of PSM on the UE. Allowed values: <ul style="list-style-type: none"> 0: Power Saving Mode is not granted by the network 1: Power Saving Mode is granted by the network |
| <Assigned_Periodic_RAU> | String | Assigned extended periodic RAU (T3312_ext) value allocated to be allocated to the UE in GERAN/UTRAN, one byte in an 8 bit format. For the coding and the value range, see the GPRS timer 3 IE in 3GPP TS 24.008 [67] |
| <Assigned_GPRS_READY_timer> | String | Assigned GPRS READY timer (T3314) value allocated to the UE in GERAN/UTRAN, one byte in an 8 bit format. For the coding and the value range, see the GPRS timer 3 IE in 3GPP TS 24.008 [67] |
| <Assigned_Periodic_TAU> | String | One byte in an 8 bit format. Assigned extended periodic TAU value (T3412_ext), if present, or assigned periodic TAU value (T3412) (if the former is not present) allocated to the UE in E-UTRAN. The assigned periodic TAU value is coded as indicated by the <Assigned_Periodic_TAU_Format_Type> parameter. See also 3GPP TS 23.682 [142], 3GPP TS 23.060 [65] and 3GPP TS 23.401 [143]. |
| <Assigned_Active_Time> | String | One byte in an 8 bit format. Assigned Active Time value (T3324) allocated to the UE in GERAN/UTRAN or in EUTRAN. The assigned Active Time value is coded as one byte (octet 3) of the GPRS timer 2 information element coded as bit format (e.g. "00100100" equals 4 minutes). For the coding and the value range, see the GPRS timer 2 IE in 3GPP TS 24.008 table 10.5.163/3GPP TS 24.008 [67]. See also 3GPP TS 23.682 [142], 3GPP TS 23.060 [65] and 3GPP TS 23.401 [143]. |
| <Assigned_Periodic_TAU_Format_Type> | Number | Coding type for <Assigned_Periodic_TAU> string. Allowed values: <ul style="list-style-type: none"> 0: the assigned periodic TAU value (T3412) is coded as one byte (octet 3) of the GPRS Timer 2 information element coded as bit format (e.g. "00100100" equals 4 minutes). For the coding and value range, see the GPRS Timer 2 IE in 3GPP TS 24.008 table 10.5.163/3GPP TS 24.008 [67]. 1: the assigned extended periodic TAU value (T3412_ext) is coded as one byte (octet 3) of the GPRS Timer 3 information element coded as bit format (e.g. "01000111" equals 70 hours). For the coding and value range, see the GPRS Timer 3 IE in 3GPP TS 24.008 table 10.5.163a/3GPP TS 24.008 [67]. |

15.3.4 Notes

SARA-R404M / SARA-R410M / SARA-N4

- <Assigned_Periodic_RAU> and <Assigned_GPRS_READY_timer> are not supported.

SARA-R410M-01B / SARA-R410M-02B / SARA-R410M-52B / SARA-R412M / SARA-N4

- The <Assigned_Periodic_TAU_Format_Type> parameter is not supported. The <Assigned_Periodic_TAU> parameter can only represent the assigned extended periodic TAU value (T3412_ext) coded as the octet 3 of a GPRS timer 3. For example, "01000111" equals 70 hours. For more details, see table 10.5.163a/3GPP TS 24.008 [67], 3GPP TS 23.682 [142] and 3GPP TS 23.401 [143].

15.4 Power Saving Mode versions configuration +UPSMVER

| +UPSMVER | | | | | | |
|-------------------|---|---------------------|-----------------------|-----------------------|----------------------|------------------------|
| Modules | SARA-R410M-02B SARA-R410M-52B SARA-R410M-63B SARA-R410M-73B SARA-R410M-83B SARA-R412M SARA-R422 SARA-R422M8S SARA-R422S | | | | | |
| Attributes | Syntax | PIN required | Settings saved | Can be aborted | Response time | Error reference |
| | full | No | NVM | No | - | +CME Error |

15.4.1 Description

Configures Power Saving Mode (PSM) versions.



Reboot the module (AT+CFUN=15 or 16) in order to apply the new configuration.

15.4.2 Syntax

| Type | Syntax | Response | Example |
|------|--|--|---|
| Set | AT+UPSMVER=[<psm_ver>],[<poi>],[<oos_scans>],[<deep_sleep_oos_dur>],[<temp_dis>]]] | OK | AT+UPSMVER=8 OK |
| Read | AT+UPSMVER? | +UPSMVER: <psm_ver>,<poi>,<oos_scans>,<deep_sleep_oos_dur>,<temp_dis> OK | +UPSMVER: 4,3,3,4,0 OK |
| Test | AT+UPSMVER=? | +UPSMVER: (list of supported <psm_ver>s),(list of supported <poi>s),(list of supported <oos_scans>s),(list of supported <deep_sleep_oos_dur>s),(list of supported <temp_dis>s) OK | +UPSMVER: (4,8),(0-3),(0-100),(2-64800),(0,1) OK |

15.4.3 Defined values

| Parameter | Type | Description |
|----------------------|--------|---|
| <psm_ver> | Number | <ul style="list-style-type: none"> SARA-R410M / SARA-R412M - Decimal number representing a four bit bitmask to indicate Power Saving Mode (PSM) versions. Each bit is configured independently: <ul style="list-style-type: none"> bit 0: PSM without network coordination bit 1: PSM according to release 12 without context retention bit 2: PSM according to release 12 with context retention bit 3: deep-sleep mode in between eDRX cycles The allowed range goes from 1 to 15, the default and factory-programmed value is 15 (all PSM versions enabled). SARA-R422 / SARA-R422M8S / SARA-R422S - Decimal number representing the enabled deep-sleep version. Allowed values: <ul style="list-style-type: none"> 4: PSM deep-sleep according to release 12 with context retention 8: deep-sleep mode in between eDRX cycles The default and factory-programmed value is 4 (PSM deep-sleep enabled). |
| <poi> | Number | Decimal number representing a two bit bitmask to indicate Paging Only Image (POI) in combination with eDRX deep-sleep enabling. Each bit is configured independently: <ul style="list-style-type: none"> bit 0: POI enabled in E-UTRAN NB-IoT bit 1: POI enabled in E-UTRAN Cat M1 The allowed range goes from 0 to 3, the default and factory-programmed value is 3 (POI in E-UTRAN NB-IoT and Cat M1 enabled). |
| <oos_scans> | Number | Decimal number representing the number of PLMN scans performed over enabled RATs and bands that need to fail for entering deep-sleep in out of service (OOS). The allowed range goes from 0 to 100, the default and factory-programmed value is 3. Setting <oos_scans> to 0 disables deep-sleep in OOS. |
| <deep_sleep_oos_dur> | Number | Deep-sleep duration in minutes, after the module enters this mode as a consequence of out of service (OOS) (for more details, see <oos_scans>). The allowed range goes from 2 to 64800, the default and factory-programmed value is 4. |
| <temp_dis> | Number | Allowed values: <ul style="list-style-type: none"> bit 0: deep-sleep can be entered whenever proper conditions are met bit 1: deep-sleep entry is temporarily disabled Deep-sleep temporary disablement is not enabled by default. The parameter is volatile and needs to be set without rebooting the module. |

15.4.4 Notes

SARA-R422 / SARA-R422M8S / SARA-R422S

- If the set command is issued and any optional parameter is omitted, the module applies the last set value.
- In case of error only the "ERROR" final result code is returned.

SARA-R410M / SARA-R412M

- <psm_ver> is the only supported parameter.
- In case of error only the "ERROR" final result code is returned.

15.5 Power Saving Mode indication +UPSMR

| +UPSMR | | | | | | |
|-------------------|---|---------------------|-----------------------|-----------------------|----------------------|------------------------|
| Modules | SARA-R410M-63B SARA-R410M-73B SARA-R410M-83B SARA-R412M SARA-R422 SARA-R422M8S SARA-R422S | | | | | |
| Attributes | Syntax | PIN required | Settings saved | Can be aborted | Response time | Error reference |
| | full | No | NVM | No | - | +CME Error |

15.5.1 Description

Enables or disables the URC that conveys information on the Power Saving Mode (PSM) states, e.g. if the module can enter PSM, or has exited from it, or if some embedded SW client or peripheral activity is postponing the entrance into PSM state. Entrance into PSM, where the protocol stack has been deactivated, is a pre-requirement to enter the deep-sleep mode, where the module is deactivated.

Where eDRX deep-sleep is supported, the same URC is also used for notifying eDRX states, in case eDRX is entered and eDRX deep-sleep is enabled (see +UPSMVER AT command).

15.5.2 Syntax

| Type | Syntax | Response | Example |
|---|-----------------|---|---------------------|
| Set | AT+UPSMR=<mode> | OK | AT+UPSMR=1 OK |
| Read | AT+UPSMR? | +UPSMR: <mode> OK | +UPSMR: 1 OK |
| Test | AT+UPSMR=? | +UPSMR: (list of supported <mode>s) OK | +UPSMR: (0-1) OK |
| Generic syntax | | | |
| URC | | +UUPSMR: <state>[,<param1>] | +UUPSMR: 1 |
| Module exiting PSM/eDRX deep-sleep | | | |
| URC | | +UUPSMR: 0 | +UUPSMR: 0 |
| Module entering PSM/eDRX deep-sleep | | | |
| URC | | +UUPSMR: 1,<image> | +UUPSMR: 1,1 |
| Client preventing PSM/eDRX deep-sleep entry (<state>=2 or <state>=3) | | | |
| URC | | +UUPSMR: <state>,<client_id> | +UUPSMR: 2,2 |

15.5.3 Defined values

| Parameter | Type | Description |
|-------------|--------|--|
| <mode> | Number | Indication to disable or enable the +UUPSMR URC: <ul style="list-style-type: none"> 0 (factory-programmed value): the +UUPSMR URC is disabled 1: the +UUPSMR URC is enabled |
| <state> | Number | Indication of the state of the module with respect to PSM: <ul style="list-style-type: none"> 0: the module is out of PSM/eDRX deep-sleep 1: the module is entering deep-sleep mode. The FW image that will be loaded when exiting deep-sleep mode is indicated by the <image> parameter (where supported) 2: deep-sleep client identified by <client_id> is preventing module from entering PSM/eDRX deep-sleep 3: the module entered PSM/eDRX and the protocol stack is in retention, but the deep-sleep client identified by <client_id> is preventing module from entering the PSM/eDRX deep-sleep |
| <image> | Number | Identifies the FW image loaded when exiting PSM/eDRX deep-sleep: <ul style="list-style-type: none"> 1: full image is being loaded 2: paging only image is being loaded |
| <client_id> | Number | Identifies the deep-sleep client that is preventing the module from entering PSM/eDRX deep-sleep: <ul style="list-style-type: none"> SARA-R4 - Allowed values: <ul style="list-style-type: none"> 0: internal arbitration algorithm is temporarily preventing the module from entering PSM deep-sleep |

| Parameter | Type | Description |
|-----------|--------|---|
| | | <ul style="list-style-type: none"> o 1: USB interface o 2: UART interface o 3: LwM2M o 4: security o 5: GNSS o 6: +UPSMVER deep-sleep temporary disablement Supported values: <ul style="list-style-type: none"> o SARA-R410M-63B / SARA-R410M-73B / SARA-R410M-83B / SARA-R412M - 0, 1, 2, 3, 4 o SARA-R422M8S - 2, 3, 4, 5, 6 o SARA-R422S - 2, 3, 4, 6 o SARA-R422 - 2, 3, 6 |
| <param1> | Number | Supported content depends on the related <state> (details are given above). |

15.5.4 Notes

SARA-R4

- <state>=3 is not supported.

SARA-R410M-63B / SARA-R410M-73B / SARA-R410M-83B / SARA-R412M

- The <image> parameter is not supported.

SARA-R412M

- <state>=2 is not supported.

SARA-R422 / SARA-R422M8S / SARA-R422S

- +UUPSMR URC is also used for notifying deep-sleep in out of service (OOS) states, in case OOS is entered and deep-sleep in OOS is enabled (see the [+UPSMVER](#) AT command).

16 GPIO

16.1 Introduction

The section describes the AT commands used to configure the GPIO pins provided by u-blox cellular modules.

16.1.1 GPIO functions

On u-blox cellular modules, GPIO pins can be opportunely configured as general purpose input or output. Moreover GPIO pins of u-blox cellular modules can be configured to provide custom functions via **+UGPIOC** AT command. The custom functions availability can vary depending on the u-blox cellular modules series and version: see [Table 24](#) for an overview of the custom functions supported by u-blox cellular modules.

| <gpio_mode> | 0 | 1 | 2 | 3 | 4 | 5 | 6 | 7 | 8 | 9 | 10 | 11 | 12 | 13 | 14 | 15 | 16 | 18 | 19 | 20 | 21 | 22 | 23 | 24 | 25 | 26 | 27 | 28 | 29 | 30 | 32 | 255 |
|--|--------|-------|---------------------------|-----------------------------|--------------------------|---------------------------|------------------------------|--------------------|-------------------|-------------------------|--------------------------|----------------------------------|-----------------------------|----------------------|-------------------------|---------------------------------------|--------------|----------------|----------------|-------------------------------------|-----------------|-------------------|----------------------------------|-------------------------|-------------|----------------------------------|------------------------|--------------------------------|--|-----------------------------------|-------------------|--------------|
| | Output | Input | Network status indication | External GNSS supply enable | External GNSS data ready | External GNSS RTC sharing | Jamming detection indication | SIM card detection | Headset detection | GSM Tx burst indication | Module status indication | Module operating mode indication | I2S digital audio interface | SPI serial interface | Master clock generation | UART (DSR, DTR, DCD and RI) interface | Wi-Fi enable | Ring indicator | Last gasp | External GNSS antenna / LNA control | Time pulse GNSS | Time pulse output | Time stamp of external interrupt | Fast and safe power-off | LwM2M pulse | Hardware flow control (RTS, CTS) | Antenna dynamic tuning | External GNSS time pulse input | External GNSS time stamp of external interrupt | DTR mode for power saving control | 32.768 kHz output | Pad disabled |
| SARA-R422S | * | * | * | * | * | | | * | | | * | | | | | | | * | * | | | | * | * | | | | | | | * | |
| SARA-R422 | * | * | | | | | | * | | | * | | | | | | | * | | | | | * | * | | | | | | | * | |
| SARA-R422M8S | * | * | * | | | | | * | | | * | | | | | | | * | * | | | | * | * | | | | | | | * | |
| SARA-R410M-63B / SARA-R410M-73B / SARA-R410M-83B | * | * | * | * | * | | | * | | | * | | | | | | | * | * | | | | | | * | | | | | | * | |
| SARA-R410M-02B | * | * | * | * | * | | | * | | | * | | | | | | | * ³ | * ⁴ | | | | | * ⁵ | | | | | | | * | |
| SARA-R410M-52B | * | * | * | * | * | | | * | | | * | | | | | | | * | * | | | | | | | | | | | | * | |
| SARA-R404M / SARA-R410M-01B | * | * | * | | | | | * | | | * | | | | | | | | | | | | | | | | | | | | * | |
| SARA-R412M | * | * | * | * | * | | | * | | | * | | | | | | | * | * | | | | | * ⁶ | | | | | | | * | |
| SARA-N4 | * | * | * | * | * | | | * | | | * | | | | | | | | | * | | | | | | | | | | | * | |

Table 24: GPIO custom functions overview

The configuration of the GPIO pins (i.e. the setting of the parameters of the **+UGPIOC** AT command) is saved in the NVM and used at the next power-on.

16.1.2 GPIO mapping

The number of available GPIO pins and their mapping can vary depending on the u-blox cellular modules series and version. The GPIOs mapping for different u-blox cellular modules is reported in the following tables.



See the corresponding module system integration manual for the functions supported by each GPIO.

³ Not supported by SARA-R410M-02B-00

⁴ Not supported by SARA-R410M-02B-00

⁵ Not supported by SARA-R410M-02B-00, SARA-R410M-02B-01, SARA-R410M-02B-02

⁶ Not supported by SARA-R412M-02B-00, SARA-R412M-02B-01, SARA-R412M-02B-02

16.1.2.1 SARA-R4 / SARA-N4 GPIO mapping

| <gpio_id> | Pin name | Pin number | Factory-programmed function | Remarks |
|-----------|----------|------------|-----------------------------|---|
| 7 | RI | 7 | Pin disabled | Only pin 7 can be configured for "UART RI line" functionality |
| 16 | GPIO1 | 16 | Pin disabled | Only pin 16 can be configured for "Network status indication" functionality. |
| 23 | GPIO2 | 23 | Pin disabled | Only pin 23 can be configured for "GNSS supply enable" functionality (where supported). |
| 24 | GPIO3 | 24 | Pin disabled | Only pin 24 can be configured for "GNSS data ready" functionality (where supported). |
| 25 | GPIO4 | 25 | Pin disabled | - |
| 42 | GPIO5 | 42 | Pin disabled | Only pin 42 can be configured for "SIM card detection" functionality |
| 19 | GPIO6 | 19 | Pin disabled | - |

Table 25: SARA-R4 / SARA-N4 series GPIO mapping

16.1.2.2 Additional notes

- SARA-R410M / SARA-R412M / SARA-R422S
The "External GNSS supply enable" and "External GNSS data ready" functions can be handled by the [+UGPS](#) and the [+UGPRF](#) AT commands to manage the u-blox GNSS receiver connected to the cellular module and the embedded GPS aiding.
- SARA-R410M / SARA-R412M / SARA-R422M8S / SARA-R422S
After having enabled the "Last gasp" feature reboot the module in order to make the change effective. For more details, see the [+ULGASP](#) AT command.
- SARA-R4
After having enabled or disabled the "SIM card detection" feature (<gpio_mode>=7), reboot the module in order to make the change effective.
- <gpio_mode>=24 (fast and safe power-off) triggers the emergency fast shutdown of the module. The process status is provided by means of the +JUFASTSHUTDOWN URC. For more details about the URC syntax, see [+CFUN](#) AT command.
- SARA-R4 / SARA-N4
When the "SIM card detection" feature is enabled, the [+CIND](#) AT command reports the status. When the "SIM card detection" feature is enabled, the status can be read with the [+UGPIOR](#) AT command.
- See the corresponding module system integration manual for the complete overview of all allowed configurations.

16.1.3 Network status indication

When a GPIO pin is configured to provide network status indication, its progress depends on the CS network registration state (see [+CREG](#)) and on the module transmission state:

- No service: indicates no network coverage or not registered state
- Registered home network 2G: indicates registered state on home network in 2G RAT
- Registered home network 3G: indicates registered state on home network in 3G RAT
- Registered home network NB-IoT: indicates registered state on home network in NB-IoT
- Registered roaming 2G: indicates registered state with visitor 2G network (roaming in 2G RAT)
- Registered roaming 3G: indicates registered state with visitor 3G network (roaming in 3G RAT)
- Registered roaming NB-IoT: indicates registered state with visitor NB-IoT network (roaming in NB-IoT)
- Data transmission: indicates voice or data call active either in 2G, 3G or 4G RAT
- Data transmission roaming: indicates voice or data call active either in 2G, 3G or 4G RAT with visitor network

The following figures report the allowed progresses for GPIO pin set as network indication: V_H and V_L values are provided in the corresponding module data sheet in the "Generic Digital Interfaces pins" section.

16.1.3.1 No service (no network coverage or not registered)

- Continuous Output / Low



Figure 1: GPIO pin progress for no service

16.1.3.2 Registered home network 2G

- Cyclic Output / High for 100 ms, Output / Low for 2 s

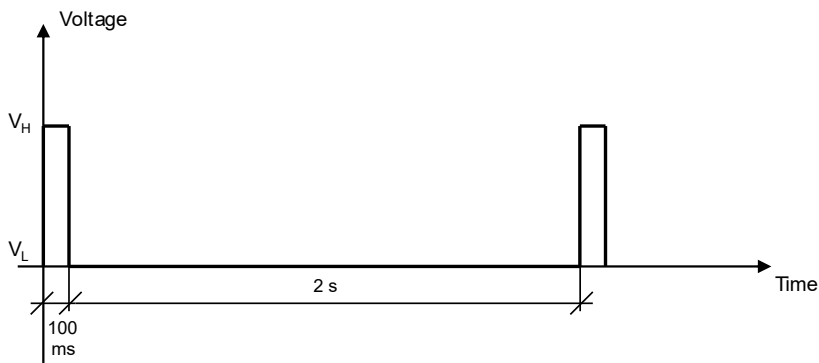

Figure 2: GPIO pin progress for registered home network 2G

16.1.3.3 Registered home network 3G

- Cyclic Output / High for 50 ms, Output / Low for 50 ms, Output / High for 50 ms, Output / Low for 2 s

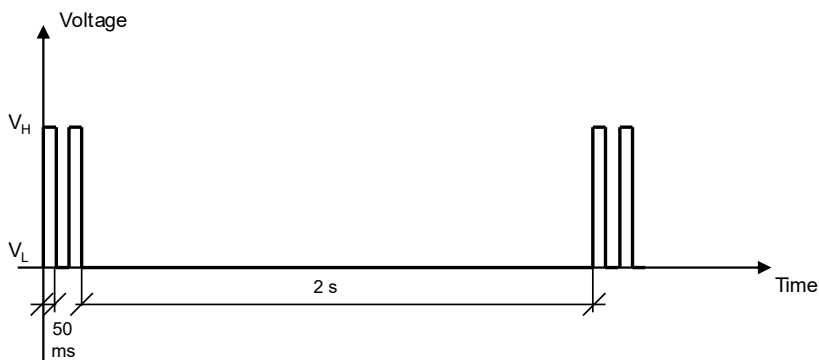

Figure 3: GPIO pin progress for registered home network 3G

16.1.3.4 Registered home network NB-IoT

- Cyclic Output / High for 100 ms, Output / Low for 30 s

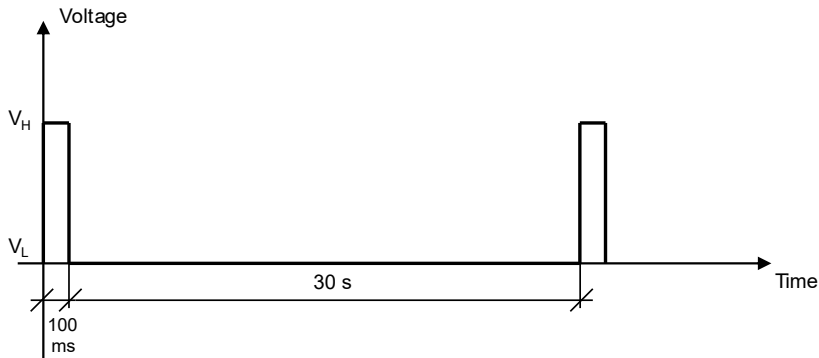

Figure 4: GPIO pin progress for registered home network NB-IoT

16.1.3.5 Registered roaming 2G

- Cyclic Output / High for 100 ms, Output / Low for 100 ms, Output / High for 100 ms, Output / Low for 2 s

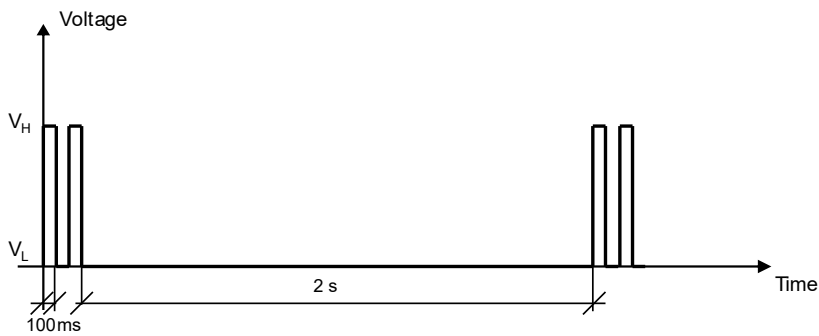

Figure 5: GPIO pin progress for registered roaming 2G

16.1.3.6 Registered roaming 3G

- Cyclic Output / High for 50 ms, Output / Low for 50 ms, Output / High for 50 ms, Output / Low for 100 ms

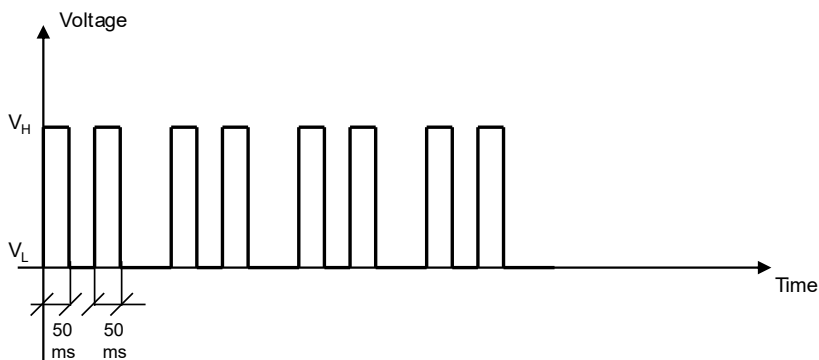

Figure 6: GPIO pin progress for registered roaming 3G

16.1.3.7 Registered roaming NB-IoT

- Cyclic Output / High for 100 ms, Output / Low for 100 ms, Output / High for 100 ms, Output / Low for 30 s

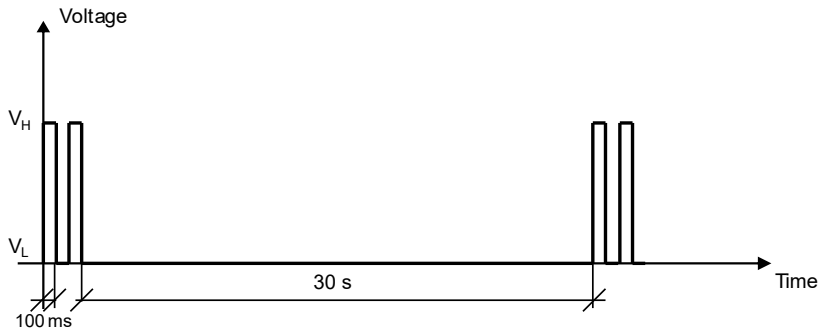

Figure 7: GPIO pin progress for registered roaming NB-IoT

16.1.3.8 Data transmission

- Continuous Output / High

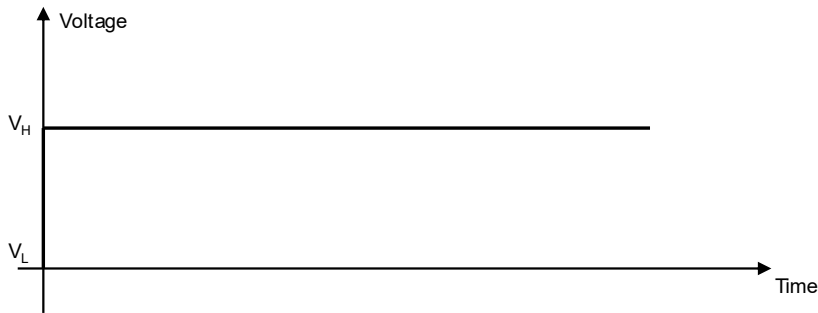

Figure 8: GPIO pin progress for data transmission

16.1.3.9 Data transmission roaming

- Cyclic Output / High for 800 ms, Output / Low for 200 ms

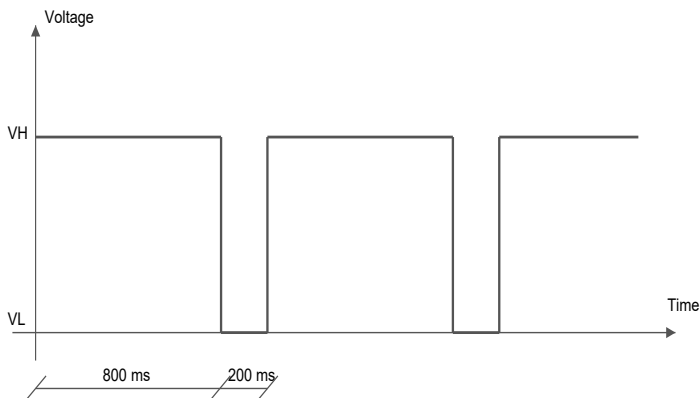

Figure 9: GPIO pin progress for data transmission roaming



SARA-R4 / SARA-N4

When registered on 4G (LTE) network, the GPIO pin progress is the same as for data transmission (Figure 8) because a PDP context/EPS bearer is available.

16.1.4 Module status indication

When a GPIO pin is configured to provide module status indication, its progress depends on the current module status (power-off mode, i.e. module switched off, versus idle, active or connected mode, i.e. module switched on):

- Output / High, when the module is switched on (any operating mode during module normal operation: idle, active or connected mode)
- Output / Low, when the module is switched off (power-off mode)

16.1.5 Module operating mode indication

When a GPIO pin is configured to provide module operating mode indication, its progress depends on the current module operating mode (the low power idle mode versus active or connected mode):

- Output / High, when the module is in active or connected mode
- Output / Low, when the module is in idle mode (that can be reached if the power saving is enabled by the [+UPSV](#) AT command)

16.2 GPIO select configuration command +UGPIOC

| +UGPIOC | | | | | | |
|-------------------|---------------|---------------------|-----------------------|-----------------------|----------------------|----------------------------|
| Modules | All products | | | | | |
| Attributes | Syntax | PIN required | Settings saved | Can be aborted | Response time | Error reference |
| | partial | No | NVM | No | < 10 s | +CME Error |

16.2.1 Description

Configures the GPIOs pins as input, output or to handle a custom function. When the GPIOs pins are configured as output pin, it is possible to set the value.

The test command provides the list of the supported GPIOs, the supported functions and the status of all the GPIOs.



Not all the GPIO functions can be assigned to each GPIO pin. If the configuration is not allowed, an error result code will be returned (error result code 1502 - "+CME ERROR: Select GPIO mode error").

The following custom functions cannot be simultaneously configured on 2 GPIOs:

- Network status indication
- External GNSS supply enable
- External GNSS data ready
- External GNSS RTC sharing
- Jamming detection indication
- SIM card detection
- Headset detection
- GSM Tx burst indication
- Module status indication
- Module operating mode indication
- Ring indicator
- Last gasp
- External GNSS antenna / LNA control
- Time pulse GNSS
- Time pulse output
- Time stamp of external interrupt
- Fast and safe power-off
- External GNSS time pulse input
- External GNSS time stamp of external interrupt
- DTR mode for power saving control
- 32.768 kHz output



For more details regarding the custom functions supported by the u-blox cellular modules and the factory-programmed settings, see [GPIO functions](#) and [GPIO mapping](#).



SARA-R410M / SARA-R412M / SARA-R422S

Stop the GNSS receiver supply by means of the `AT+UGPS=0` command, to change the functionality of the GPIO currently set as "External GNSS supply enable".

16.2.2 Syntax

| Type | Syntax | Response | Example |
|------|---|---|--|
| Set | AT+UGPIOC=<gpio_id>,<gpio_mode>[,<gpio_out_val>\<gpio_in_pull>] | OK | AT+UGPIOC=20,0,1 OK |
| Read | AT+UGPIOC? | +UGPIOC: <gpio_id>,<gpio_mode> [<gpio_id>,<gpio_mode> [...]] OK | +UGPIOC: 20,0 21,3 23,255 24,255 42,7 OK |
| Test | AT+UGPIOC=? | +UGPIOC: (list of supported <gpio_id>),(list of supported <gpio_mode>),(list of supported <gpio_out_val>\<gpio_in_pull>) [<gpio_id1>,<gpio_mode> ... <gpio_idN>,<gpio_mode>] OK | +UGPIOC: (20,21,23,24,42),(0-5,7,9,255),(0-2) OK |

16.2.3 Defined values

| Parameter | Type | Description |
|-------------|--------|---|
| <gpio_id> | Number | GPIO pin identifier: pin number See the GPIO mapping for the available GPIO pins, their mapping and factory-programmed values on different u-blox cellular modules series and product version. |
| <gpio_mode> | Number | Mode identifier: configured function See the GPIO functions for custom functions supported by different u-blox cellular modules series and product version. Allowed values: <ul style="list-style-type: none"> • 0: output • 1: input • 2: network status indication • 3: external GNSS supply enable • 4: external GNSS data ready • 5: external GNSS RTC sharing • 6: jamming detection indication • 7: SIM card detection • 8: headset detection • 9: GSM Tx burst indication • 10: module status indication • 11: module operating mode indication • 12: I²S digital audio interface • 13: SPI serial interface • 14: master clock generation • 15: UART (DSR, DTR, DCD e RI) interface • 16: Wi-Fi enable • 18: ring indicator • 19: last gasp • 20: external GNSS antenna / LNA control enable |

| Parameter | Type | Description |
|----------------|--------|---|
| | | <ul style="list-style-type: none"> • 21: time pulse GNSS • 22: time pulse output • 23: time stamp of external interrupt • 24: fast and safe power-off • 25: LwM2M pulse • 26: hardware flow control (RTS, CTS) • 27: antenna dynamic tuning • 28: external GNSS time pulse input • 29: external GNSS time stamp of external interrupt • 30: DTR mode for power saving control • 32: 32.768 kHz output • 255: pad disabled |
| <gpio_out_val> | Number | GPIO output value (for output function <gpio_mode>=0 only): <ul style="list-style-type: none"> • 0 (default value): low • 1: high |
| <gpio_in_pull> | Number | GPIO input value (for input function <gpio_mode>=1 only): <ul style="list-style-type: none"> • 0 (default value): no resistor activated • 1: pull up resistor active • 2: pull down resistor active |

16.3 GPIO read command +UGPIOR

| +UGPIOR | | | | | | |
|------------|--------------|--------------|----------------|----------------|---------------|-----------------|
| Modules | All products | | | | | |
| Attributes | Syntax | PIN required | Settings saved | Can be aborted | Response time | Error reference |
| | full | No | No | No | < 10 s | +CME Error |

16.3.1 Description

Reads the current value of the specified GPIO pin, no matter whether it is configured as input or output (see the [+UGPIOC](#) AT command to define the GPIO function). The parameters range is shown in the information text response to the test command.

16.3.2 Syntax

| Type | Syntax | Response | Example |
|------|---------------------|---|-------------------------------------|
| Set | AT+UGPIOR=<gpio_id> | +UGPIOR: <gpio_id>,<gpio_val> OK | AT+UGPIOR=20 +UGPIOR: 20,0 OK |
| Test | AT+UGPIOR=? | +UGPIOR: (list of supported <gpio_id>s) OK | +UGPIOR: (20, 21) OK |

16.3.3 Defined values

| Parameter | Type | Description |
|------------|--------|---|
| <gpio_id> | Number | GPIO pin identifier: pin number See the GPIO mapping for the available GPIO pins, their mapping and factory-programmed values on different u-blox cellular modules series and version. |
| <gpio_val> | Number | GPIO value. Allowed values are 0 and 1. |

16.3.4 Notes

- The set command works only if the <gpio_mode> parameter of the [+UGPIOC](#) AT command is set to 0 or 1.

16.4 GPIO set command +UGPIOW

+UGPIOW

| Modules | All products | | | | | |
|------------|--------------|--------------|----------------|----------------|---------------|-----------------|
| Attributes | Syntax | PIN required | Settings saved | Can be aborted | Response time | Error reference |
| | full | No | No | No | < 10 s | +CME Error |

16.4.1 Description

Sets ("writes") the output of the specified GPIO pin, but only if it is configured in output function (see the [+UGPIOC](#) AT command to set the pin as output).

16.4.2 Syntax

| Type | Syntax | Response | Example |
|------|------------------------------------|---|-------------------------------|
| Set | AT+UGPIOW=<gpio_id>,<gpio_out_val> | OK | AT+UGPIOW=20,1 OK |
| Test | AT+UGPIOW=? | +UGPIOW: (list of supported <gpio_id>s),(list of supported <gpio_out_val>s) OK | +UGPIOW: (20, 21),(0-1) OK |

16.4.3 Defined values

| Parameter | Type | Description |
|----------------|--------|---|
| <gpio_id> | Number | GPIO pin identifier: pin number See the GPIO mapping for the available GPIO pins, their mapping and factory-programmed values on different u-blox cellular modules series and version. |
| <gpio_out_val> | Number | GPIO value. Allowed values are 0 and 1. |

16.4.4 Notes

- The set command works only if the <gpio_mode> parameter of the [+UGPIOC](#) AT command is set to 0.

17 File System

17.1 File tags



17.1.1 Description

File system commands have the optional <tag> parameter that allows the user to specify a file type when a file system AT command is issued, to inform the system what to do with it. Application specific files must be saved with the correct type tag, otherwise they are treated as common user files.

The file tag applicability depends on the module series: see [Table 26](#) for the allowed tags supported by the interested product. An overview about each file tag is provided in [Table 27](#).

| Module | "USER" | "FOAT" | "AUDIO" | "ECALL_EXT" | "FOTA_EXT" | "AUDIO_EXT" | "PROFILE" | "GNS" | "CALLSRV_EXT" | "XLWM2M" | "MNO" |
|--|--------|--------|---------|-------------|------------|-------------|-----------|-------|---------------|----------|-------|
| SARA-R4 | * | * | | | | | * | | | * | |
| SARA-R404M / SARA-R410M-01B / SARA-R410M-52B | * | * | | | | | * | | | | |
| SARA-N4 | * | * | | | | | * | | | | |

Table 26: Tag applicabilities to module series

| Tag | Name | Specification |
|-------------|---|--|
| "USER" | User file system | <p>This is the default type if the <tag> parameter is omitted in file system AT commands. All generic files can be stored in this manner.</p> <p>Example: AT+UDWNFILE="foobar", 25, "USER" is the same as AT+UDWNFILE="foobar", 25</p> |
| "FOAT" | FOAT file system | <p>This tag is used to specify the file type as a firmware update package. It will place the firmware update package in the proper file cache to be used later by the +UFWINSTALL command.</p> <p> SARA-R4 / SARA-N4 The files specified with the "FOAT" tag (used to specify the firmware update package file) can only be downloaded. The +URDFILE, +URDBLOCK, +ULSTFILE, +UDWNBLOCK and +UDELFILE AT commands are not allowed.</p> |
| "AUDIO" | Audio parameters | <p>This tag is used to store audio calibration file "audio_gain_calibration<X>.xml" and "voice<X>.nvm" in the selected profile <X>=0,1. The profile is stored into NVM by using ATZ<X>.</p> <p> The "audio_gain_calibration<X>.xml" and "voice<X>.nvm" files can be overwritten with AT&W<X> command.</p> |
| "ECALL_EXT" | eCall controller configuration and custom eCall prompts | <p>This tag is used to read, download and delete the eCall controller configuration (see the eCall implementation in u-blox cellular modules application note [44]) or download and delete custom eCall prompts (see the eCall Prompts section). Reading and downloading commands use a dedicated channel of the USB CDC-ACM interface.</p> <p>To download the eCall controller configuration or custom eCall prompts in the module, use the +UDWNFILE command.</p> <p>To read the eCall controller configuration from the module, use the +URDFILE command.</p> <p>To delete eCall controller configuration or custom eCall prompts from the module, use the +UDELFILE command.</p> |

⁷ Not supported by SARA-R410M-02B-00, SARA-R410M-02B-01, SARA-R410M-02B-02, SARA-R412M-02B-00, SARA-R412M-02B-01, SARA-R412M-02B-02

| Tag | Name | Specification |
|---------------|--|---|
| "FOTA_EXT" | Firmware for FOTA procedure | This tag has to be used to store the firmware file for the FOTA procedure using a dedicated channel of the USB CDC-ACM interface. |
| "AUDIO_EXT" | Audio configuration | <p>This tag is used to read or download audio configuration (see Audio parameters tuning section). The audio configuration file includes the NVM settings of the following AT commands (where applicable):</p> <ul style="list-style-type: none"> • +CLVL AT command • +CRSL AT command • +UI2S AT command • +UMAFE AT command • +USAFE AT command • +UMSEL AT command • +UMGC AT command • +USGC AT command • +USPM AT command • +UTI AT command <p>To download the audio configuration in the module, use the +UDWNFILE command.</p> <p>To read configuration from the module, use the +URDFILE command.</p> |
| "PROFILE" | Profile files | This tag refers to the profile files that can be loaded on to the module to support Mobile Network Operators (MNOs) specific configurations. For more details on the profiles, see the +UMNOPROF command. The +URDFILE and +ULSTFILE AT commands are not allowed with this tag, the user can only download or delete these files. |
| "GNSS" | GNSS files | This tag has to be used to store the firmware file for the internal GNSS receiver. |
| "CALLSRV_EXT" | Emergency Call Number List (ECNL) management | <p>This tag is used to manage the Emergency Call Number List (ECNL) file stored in NVM. All numbers in the list will be treated as emergency numbers when dialled and will result in disabling the thermal daemon software shutdown. Some notes about ECNL:</p> <ul style="list-style-type: none"> • If eCall is enabled, the ECNL list is not used and call is treated as any normal call. • Conflict manager will not manage these calls, meaning no ongoing calls will be dropped. • Maximum allowed numbers in the ECNL list is 20. Numbers after 20 will be ignored. • Reboot is required to reload the ECNL list after download. <p>File should be composed by text lines consisting of 'type','number' lines that end with carriage return where 'type' is a type of the number in 'number' according to one of the formats supported by 3GPP TS 24.008 [67] sub-clause 10.5.4.7).</p> <p>All numbers that start with '00' should be stored with '+' instead in order to keep only one occurrence for international number. In order to manage numbers properly the configuration file should contain the number with international prefix and without it.</p> <p>Example of a two line ECNL file:</p> <pre>2,+390123456789 2,390123456789</pre> |
| "XLWM2M" | LwM2M object script files | <p>This tag is used to read or store Lua files defining a LwM2M object for use by the LwM2M client. The file specified with the "XLWM2M" can be only downloaded completely (see +UDWNFILE AT command), deleted (see +UDELFILE AT command), fully or partially read (see +URDFILE or +URDBLOCK) and queried (see +ULSTFILE AT command).</p> <p> SARA-R4 If the +UDWNBLOCK AT command is issued to partially download file with the "XLWM2M" type tag, the module returns an error result code.</p> |
| "MNO" | ICCID and MCC/MNC MNO lists | This tag refers to the files containing the ICCID and MCC/MNC MNO lists used by the SIM ICCID/IMSI selection (see the +UMNOPROF AT command). The file specified with the "MNO" tag can be downloaded to the module (see the +UDWNFILE AT command), deleted (see the +UDELFILE AT command), fully or partially read (see the +URDFILE or +URDBLOCK AT commands) and queried (see the +ULSTFILE AT command). Depending on the file name (<filename>) |

| Tag | Name | Specification |
|-----|------|---|
| | | <p>the file contains the ICCID and MCC/MNC MNO lists. The allowed file names are:</p> <ul style="list-style-type: none"> "iccid_list": SIM Issuer Identifier Number (IIN) list. The list format is: MNO1%iccid1%iccid2%MNO2%iccid3%iccid4...%MNO%iccidm. By factory-programmed configuration no iccid_list file is stored in the module file system. "mno_list": MCC and MNC list. The list format: MNO1%mcc1mnc1%mcc2mnc2%MNO2%mcc3mnc3...%MNO%mcckmnck. By factory-programmed configuration the following mno_list file is stored in the module file system: <pre>ATT%310150%310170%310410%310560%311180%310030%310280 %310950%313790%VZW%310890%311480%311270%310010%310012 %310013%310590%310890%310910%311110%311270%311271 %311272%311273%311274%311275%311276%311277%311278 %311279%311280%311281%311282%311283%311284%311285 %311286%311287%311288%311289%311390%311480%311481 %311482%311483%311484%311485%311486%311487%311488 %311489%TELSTRA%50501%50571%50572%FN%313100%312670 %313130%313140%313110%313120%TMOUS%310660%310160 %310270%310310%310490%310800%310200%310210%310220 %310230%310240%310250%310260</pre> <p>Allowed MNO1,..., MNO% values for both iccid_list and mno_list files are:</p> <ul style="list-style-type: none"> ATT: AT&T VZW: Verizon CB: Generic voice capable AT&T FN: FirstNet TELSTRA: Telstra TMOUS: T-Mobile US <p>The maximum entries number in the MCC/MNC list and ICCID list is 256 and the file overall maximum size is 2048 bytes.</p> |

Table 27: Tag meanings

17.2 Download file +UDWNFILE

| +UDWNFILE | | | | | | |
|------------|--------------|--------------|----------------|----------------|---------------|-----------------|
| Modules | All products | | | | | |
| Attributes | Syntax | PIN required | Settings saved | Can be aborted | Response time | Error reference |
| | partial | No | No | No | - | +CME Error |

17.2.1 Description

Stores (writes) a file into the file system:

- The stream of bytes can be entered after the '>' prompt has been provided to the user. The file transfer is terminated exactly when <size> bytes have been entered and either "OK" final result code or an error result code is returned. The feed process cannot be interrupted i.e. the command mode is re-entered once the user has provided the declared the number of bytes.
- If the file already exists, the data will be appended to the file already stored in the file system.
- If the data transfer stops, after 20 s the command is stopped and the "+CME ERROR: FFS TIMEOUT" error result code (if +CMEE: 2) is returned.
- If the module shuts down during the file storing, all bytes of the file will be deleted.
- If an error occurs during the file writing, the transfer is aborted and it is up to the user to delete the file.



SARA-R4 / SARA-N4

On the UART interface, if the data transfer stops, the command is stopped and the "+CME ERROR: FFS TIMEOUT" error result code (if +CMEE: 2) is returned after 30 s.



SARA-R4 / SARA-N4

The available free memory space is checked before starting the file transfer. If the file size exceeds the available space, the "+CME ERROR: NOT ENOUGH FREE SPACE" error result code will be provided (if +CMEE: 2).

- SARA-R422 / SARA-R422M8S / SARA-R422S**
 For the FOTA file (**+UDWNFILE** of a "FOAT"-tagged file), if the file already exists, the data is overwritten.
- SARA-R404M / SARA-R410M-01B / SARA-N4**
 If the HW flow control is disabled (**AT+IFC**), a data loss could be experienced. So the HW flow control usage is strongly recommended. If HW flow control is not supported, the use of **+UDWNBLOCK** is recommended.
- SARA-R410M-02B / SARA-R410M-52B**
 On SARA-R410M-02B-00 and SARA-R410M-52B-00, if the HW flow control is disabled (**AT+IFC**), a data loss could be experienced. So the HW flow control usage is strongly recommended. If HW flow control is not supported, the use of **+UDWNBLOCK** is recommended.

17.2.2 Syntax

| Type | Syntax | Response | Example |
|-------------------------------------|--|----------|---|
| Set | AT+UDWNFILE=<filename>,<size>[,<tag>] > <text> | [, OK | AT+UDWNFILE="filename",36, "USER" > The 36 downloaded bytes of the file! OK |
| Download audio configuration | | | |
| Set | AT+UDWNFILE=<filename>,<size>,<tag> "AUDIO_EXT" | , OK | AT+UDWNFILE="audioconfig",4873, "AUDIO_EXT" OK |

17.2.3 Defined values

| Parameter | Type | Description |
|------------|--------|---|
| <filename> | String | Filename. For file system filename and data size limits see File system limits . |
| <size> | Number | File size expressed in bytes. For file system filename and data size limits see File system limits . |
| <tag> | String | Optional parameter that specifies the application file type. FILE TAGS table lists the allowed <tag> strings. For more details on specific limitations, see Notes . |
| <text> | String | Stream of bytes. |

17.2.4 Notes

- Issue the **AT+ULSTFILE=1** command to retrieve the available user space in the file system.
- Two files with different types can have the same name, i.e. **AT+UDWNFILE="testfile",20,"USER"** and **AT+UDWNFILE="testfile",43,"AUDIO"**.

SARA-R4 / SARA-N4

- The <tag> parameter is mandatory for firmware package transfer. The tag must be given as "FOAT" for FW download, and "PROFILE" for carrier profile. For more details, see [FILE TAGS](#).

17.3 List files information +ULSTFILE

| +ULSTFILE | | | | | | |
|------------------|--------------|--------------|----------------|----------------|---------------|----------------------------|
| Modules | All products | | | | | |
| Attributes | Syntax | PIN required | Settings saved | Can be aborted | Response time | Error reference |
| | partial | No | No | No | - | +CME Error |

17.3.1 Description

Retrieves some information about the FS. Depending on the specified <op_code>, it can print:

- List of files stored into the FS
- Remaining free FS space expressed in bytes
- Size of the specified file expressed in bytes

The available free space on FS in bytes reported by the command AT+ULSTFILE=1 is the theoretical free space including the space occupied by the hidden and temporary files which are not displayed by the AT+ULSTFILE=0.

17.3.2 Syntax

| Type | Syntax | Response | Example |
|---|---|--|--|
| Generic syntax | | | |
| Set | AT+ULSTFILE=[<op_code>[,<param1>[,<param2>]]] | +ULSTFILE: [<param3>,...[,<paramN>]] OK | |
| List of files stored into the FS | | | |
| Set | AT+ULSTFILE=[0[,<tag>]] | +ULSTFILE: [<filename1>[,<filename2>[,...[,<filenameN>]]]] OK | AT+ULSTFILE= +ULSTFILE: "filename1","filename2" OK |
| | | See notes below | See notes below |
| Remaining free FS space expressed in bytes | | | |
| Set | AT+ULSTFILE=1[,<tag>] | +ULSTFILE: <free_fs_space> OK | AT+ULSTFILE=1 +ULSTFILE: 236800 OK |
| Size of the specified file | | | |
| Set | AT+ULSTFILE=2,<filename>[,<tag>] | +ULSTFILE: <file_size> OK | AT+ULSTFILE=2,"filename" +ULSTFILE: 784 OK |

17.3.3 Defined values

| Parameter | Type | Description |
|-----------------------------|-----------------|--|
| <op_code> | Number | Allowed values are: <ul style="list-style-type: none"> 0 (default value): lists the files belonging to <tag> file type 1: gets the free space for the specific <tag> file type 2: gets the file size expressed in bytes, belonging to <tag> type (if specified) |
| <tag> | String | Specifies the application file type. FILE TAGS table lists the allowed <tag> strings. |
| <filename1>,...,<filenameN> | String | Filename. For file system filename and data size limits see File system limits . |
| <free_fs_space> | Number | Available free space on FS in bytes. |
| <file_size> | Number | Size of the file specified with the <filename> parameter. |
| <param1> | Number / String | Type and supported content depend on related <op_code> (details are given above). |
| <param2> | Number / String | Type and supported content depend on related <op_code> (details are given above). |

17.4 Read file +URDFILE

| +URDFILE | | | | | | |
|-------------------|---------------|---------------------|-----------------------|-----------------------|----------------------|----------------------------|
| Modules | All products | | | | | |
| Attributes | Syntax | PIN required | Settings saved | Can be aborted | Response time | Error reference |
| | partial | No | No | No | - | +CME Error |

17.4.1 Description

Retrieves a file from the file system.

SARA-R4 / SARA-N4
If the HW flow control is disabled ([AT+IFC](#)), a data loss could be experienced. So the HW flow control usage is strongly recommended. If HW flow control is not supported, the use of [+URDBLOCK](#) is recommended.

17.4.2 Syntax

| Type | Syntax | Response | Example |
|------|-------------------------------|--|---|
| Set | AT+URDFILE=<filename>[,<tag>] | +URDFILE: <filename>,<size>, <data> OK | AT+URDFILE="filename" +URDFILE: "filename",36,"these bytes are the data of the file" OK |

17.4.3 Defined values

| Parameter | Type | Description |
|------------|--------|--|
| <filename> | String | Filename. For file system filename and data size limits, see File system limits . |
| <tag> | String | The optional parameter <tag> specifies a different application file type. FILE TAGS table lists the allowed <tag> strings. |
| <size> | Number | File size, in bytes. |
| <data> | String | File content. |

17.4.4 Notes

- The returned file data is displayed as an ASCII string of <size> characters in the range [0x00,0xFF]. At the end of the string, <CR><LF> are provided for user convenience and visualization purposes.

17.5 Partial read file +URDBLOCK

| +URDBLOCK | | | | | | |
|-------------------|---|---------------------|-----------------------|-----------------------|----------------------|----------------------------|
| Modules | SARA-R410M-02B SARA-R410M-52B SARA-R410M-63B SARA-R410M-73B SARA-R410M-83B SARA-R412M SARA-R422 SARA-R422M8S SARA-R422S SARA-N4 | | | | | |
| Attributes | Syntax | PIN required | Settings saved | Can be aborted | Response time | Error reference |
| | partial | No | No | No | - | +CME Error |

17.5.1 Description

Retrieves a file from the file system.



Differently from [+URDFILE](#) command, this command allows the user to read only a portion of the file, indicating the offset and amount of bytes.

17.5.2 Syntax

| Type | Syntax | Response | Example |
|------|--|---|--|
| Set | AT+URDBLOCK=<filename>, <offset>,<size>[,<tag>] | +URDBLOCK: <filename>,<size>, <data> OK | AT+URDBLOCK="filename",0,20 +URDBLOCK: "filename",20,"these bytes are the " OK |

17.5.3 Defined values

| Parameter | Type | Description |
|------------|--------|--|
| <filename> | String | Filename. For file system filename and data size limits see File system limits . |
| <offset> | Number | Offset in bytes from the beginning of the file. |
| <size> | Number | Number of bytes to be read starting from the <offset>. |
| <data> | String | Content of the file read. |
| <tag> | String | The optional parameter <tag> specifies a different application file type. FILE TAGS table lists the allowed <tag> strings. |

17.5.4 Notes

- The returned file data is displayed as an ASCII string of <length> characters in the range [0x00,0xFF]. At the end of the string, <CR><LF> are provided for user convenience and visualization purposes.

- In case a size larger than the whole file size is required the command returns the file size only, indicating the amount of bytes read.
- In case an offset larger than the whole file size is required, the "+CME ERROR: FFS file range" error result code is triggered.

SARA-R4 / SARA-N4

- The <tag> parameter is not supported.

17.6 Delete file +UDELFILE

| +UDELFILE | | | | | | |
|-------------------|---------------|---------------------|-----------------------|-----------------------|----------------------|------------------------|
| Modules | All products | | | | | |
| Attributes | Syntax | PIN required | Settings saved | Can be aborted | Response time | Error reference |
| | partial | No | No | No | - | +CME Error |

17.6.1 Description

Deletes a stored file from the file system.



SARA-R4 / SARA-N4

If <filename> file is not stored in the file system the following error result code will be provided: "+CME ERROR: FILE NOT FOUND".

17.6.2 Syntax

| Type | Syntax | Response | Example |
|------|--------------------------------|----------|-------------------------------------|
| Set | AT+UDELFILE=<filename>[,<tag>] | OK | AT+UDELFILE="filename","USER" OK |

17.6.3 Defined values

| Parameter | Type | Description |
|------------|--------|--|
| <filename> | String | Filename. For file system filename and data size limits see File system limits . |
| <tag> | String | The optional parameter <tag> specifies a different application file type. FILE TAGS table lists the allowed <tag> strings. |

17.7 Partial download file +UDWNBLOCK

| +UDWNBLOCK | | | | | | |
|-------------------|---|---------------------|-----------------------|-----------------------|----------------------|------------------------|
| Modules | SARA-R410M-02B SARA-R410M-52B SARA-R410M-63B SARA-R410M-73B SARA-R410M-83B SARA-R412M SARA-R422 SARA-R422M8S SARA-R422S SARA-N4 | | | | | |
| Attributes | Syntax | PIN required | Settings saved | Can be aborted | Response time | Error reference |
| | full | No | No | No | - | +CME Error |

17.7.1 Description

Stores (writes) a file to the file system:

- The stream of bytes can be entered after the '>' prompt has been provided to the user. The file transfer is terminated exactly when <size> bytes have been sent entered and either "OK" final result code or an error result code is returned. The feed process cannot be interrupted i.e. the command mode is re-entered once the user has provided the declared number of bytes.
- If the file already exists, the data will be appended to the file already stored in the file system.
- If the data transfer stops, after 20 s the command is stopped and the "+CME ERROR: FFS TIMEOUT" error result code (if +CMEE=2) is returned.
- If the module shuts down during the file storing, all bytes of the file will be deleted.
- If an error occurs during the file writing, the transfer is aborted and it is up to the user to delete the file.



Differently from +UDWNFILE AT command, this command allows the user to write only a portion of the file, indicating the offset and amount of bytes.

17.7.2 Syntax

| Type | Syntax | Response | Example |
|------|---|----------|--|
| Set | AT+UDWNBLOCK=<filename>,<offset>,<size>,<filesize>[,<tag>] > <text> | OK | AT+UDWNBLOCK="filename",0,36,500,"USER" > The 36 downloaded bytes of the file! OK |

17.7.3 Defined values

| Parameter | Type | Description |
|------------|--------|--|
| <filename> | String | Filename. For file system filename and data size limits, see File system limits . |
| <offset> | Number | Offset in bytes from the beginning of the file. |
| <size> | Number | Number of bytes to be written starting from the <offset>. |
| <filesize> | Number | The size of the file to be written |
| <tag> | String | The optional parameter <tag> specifies a different application file type. FILE TAGS table lists the allowed <tag> strings. |

17.7.4 Notes

- The <tag> parameter is supported only for "USER".

17.8 File system limits

17.8.1 Allowed characters in filenames

A filename cannot contain the following characters: / * : % | " < > ?

17.8.2 Limits

Here below are listed the maximum filename length, the maximum data size of the file system and the maximum number of files for the u-blox cellular modules.

Maximum filename length:

- SARA-R4 / SARA-N4 - 248 characters

Maximum file size:

- SARA-R4 / SARA-N4 - File size limited by the available file system space retrieved by `+ULSTFILE=1` command

Maximum number of files:

- SARA-R4 / SARA-N4 - The theoretical maximum number of files that can be stored is 1100.



The theoretical maximum file size and the maximum number of files also includes system, hidden and temporary files whose number is not statically predictable, so the actual numbers can be less than stated.

18 DNS

DNS service requires the user to define and activate a connection profile, either PSD or CSD.

SARA-R410M / SARA-R412M / SARA-R422 / SARA-R422M8S / SARA-R422S / SARA-N4
See **+UPSD** AT command for CID mapping and **+CGACT** for activating a PDP context.

When these command report an error which is not a +CME ERROR, the error class and code is provided through **+USOER** AT command.

18.1 Resolve name / IP number through DNS +UDNSRN

| +UDNSRN | | | | | | |
|-------------------|---|---------------------|-----------------------|-----------------------|----------------------|------------------------|
| Modules | SARA-R410M-02B SARA-R410M-52B SARA-R410M-63B SARA-R410M-73B SARA-R410M-83B SARA-R412M SARA-R422 SARA-R422M8S SARA-R422S SARA-N4 | | | | | |
| Attributes | Syntax | PIN required | Settings saved | Can be aborted | Response time | Error reference |
| | full | No | No | No | < 130 s | TCP/UDP/IP Error |

18.1.1 Description

Translates a domain name to an IP address or an IP address to a domain name by using an available DNS. There are two available DNSs, primary and secondary. The network usually provides them after a GPRS activation or a CSD establishment. They are automatically used in the resolution process if available. The resolver will use first the primary DNS, otherwise if there is no answer, the second DNS will be involved.

The DNS resolution timeout depends on the number of DNS servers available to the DNS resolution system. The response time for the DNS resolution is estimated in case 8 servers are used to perform this task.

SARA-R4 / SARA-N4
Pay attention to the DNS setting for the different profiles since the user DNS can be put into action if the corresponding profile is activated (if the user sets a DNS for a profile, and a different profile is activated, the user DNS has no action and the network DNS is used if available).

18.1.2 Syntax

| Type | Syntax | Response | Example |
|------|--|--|--------------------------------|
| Set | AT+UDNSRN=<resolution_type>,<domain_ip_string>[,<async>] | +UDNSRN: <resolved_ip_address> | AT+UDNSRN=0,"www.google.com" |
| | | OK | +UDNSRN: "216.239.59.147" |
| | | or | OK |
| | | +UDNSRN: <resolved_domain_name> | AT+UDNSRN=0,"www.google.com",1 |
| URC | | OK | OK |
| | | +UUDNSRN: <result_code>[,<resolved_ip_address>] | +UUDNSRN: "216.239.59.147" |
| | | +UUDNSRN: <result_code>[,<resolved_domain_name>] | AT+UDNSRN=0,"www.google.com",0 |
| | | +UUDNSRN: -1 | +UDNSRN: "216.239.59.147" |
| | | | OK |
| | | +UUDNSRN: 0,"216.239.59.147" | |
| | | +UUDNSRN: 0,"somedomain.com" | |
| | | +UUDNSRN: -1 | +UUDNSRN: -1 |

18.1.3 Defined values

| Parameter | Type | Description |
|-------------------|--------|--|
| <resolution_type> | Number | Type of resolution operation: <ul style="list-style-type: none"> 0: domain name to IP address |

| Parameter | Type | Description |
|------------------------|--------|---|
| | | <ul style="list-style-type: none"> 1: IP address to domain name (host by name) |
| <domain_ip_string> | String | Domain name (<resolution_type>=0) or the IP address in (<resolution_type>=1) to be resolved |
| <async> | Number | Asynchronous DNS resolution flag. Allowed values: <ul style="list-style-type: none"> 0 (default value): the final result code is returned only once the DNS response is available, locking the AT interface until the DNS activity is running 1: a final result code (OK or an error result code) is returned immediately unlocking the AT interface and making it available for the execution of other AT commands. Once the result of DNS resolution becomes available, it is notified to the AT interface through the +UUDNSRN URC |
| <resolved_ip_address> | String | Resolved IP address corresponding to the specified domain name |
| <resolved_domain_name> | String | Resolved domain name corresponding to the provided IP address |
| <result_code> | Number | Result code of DNS resolution: <ul style="list-style-type: none"> 0: no error -1: DNS resolution failed. In this case the <resolved_ip_address> or the <resolved_domain_name> fields are not present |

18.1.4 Notes

SARA-R4 / SARA-N4

- The <async> parameter and the +UUDNSRN URC are not available.

SARA-R410M-02B

- The command is not supported by SARA-R410M-02B-00.

18.2 Dynamic DNS update +UDYNDNS

| +UDYNDNS | | | | | | |
|------------|-----------------------------------|--------------|----------------|----------------|----------------|-----------------|
| Modules | SARA-R422 SARA-R422M8S SARA-R422S | | | | | |
| Attributes | Syntax | PIN required | Settings saved | Can be aborted | Response time | Error reference |
| | full | No | NVM | No | - (except URC) | +CME Error |

18.2.1 Introduction

The IP address assigned to a module by the network provider is often dynamic; this means the IP address changes every time a PDP context is enabled.

This could be a problem when it is needed to identify an internet host with a domain name, because they are usually used with static IP address that never changes (or rarely changes).

To solve this problem, the dynamic DNS services provide a way to assign a domain name to a host that owns a dynamic IP address, but they require a client that sends the latest IP given by the network to these services, to update their DNS tables.

With the +UDYNDNS command u-blox cellular modules can access to dynamic DNS services.

This functionality is disabled by default, but once configured and enabled it automatically sends updates to the configured Dynamic DNS service every time the module IP address change. The functionality only works for internal PDP context (see [Multiple PDP contexts](#)).

18.2.2 Description

Sets up the dynamic DNS client functionality. This command is part of the internal TCP/IP stack so it only works for internal PDP contexts (managed by +UPSD and +UPSDA command; see the [Multiple PDP contexts](#)).

The command configuration is stored into the NVM: if enabled, it automatically works after a reboot.





The following dynamic DNS providers are supported:

- TZO.com
- DynDNS.org
- DynDNS.it

- No-IP.org
- DNSDynamic.org

During the service subscription phase the dynamic DNS provider gives a domain name, a username and a password that the AT application will use later.

If the DYNDNS client is enabled when an internal PDP connection is already active, the DYNDNS client starts working on the next PDP context activation.

-  Before changing the dynamic DNS client configuration it is required to stop (deactivate) it. Any attempt to reconfigure an already running DNS client raises an error.
-  The dynamic DNS update is not allowed during the first 60 s after module power on. If a PDP connection is established before this time, a URC notifies that the update has been delayed. In this case the update is performed once the 60 s are elapsed.
-  The dynamic DNS protocol does not allow more than one update every 60 s, anyhow the module's DYNDNS client will respect specific timing rules depending on the selected provider policies.
-  Due to the various caches involved in the DNS resolution process, the time since the DNS update is done until it is available for a user, can significantly change among different internet providers.

18.2.3 Syntax

| Type | Syntax | Response | Example |
|------|--|--|--|
| Set | AT+UDYNDNS=<on_off>[,<service_id>,<domain_name>,<username>,<password>] | OK | <p>Enable the dynamic DNS client using the TZO DNS service and the domain name "remote001.tzo.net".</p> <pre>AT+UDYNDNS=1,0,"remote001.tzo.net","dummy_username","dummy_password"</pre> <p>OK</p> <p>Disable the dynamic DNS client:</p> <pre>AT+UDYNDNS=0</pre> <p>OK</p> |
| Read | AT+UDYNDNS? | +UDYNDNS: <on_off>,<service_id>,<domain_name>,<username>,<password> OK | +UDYNDNS: 1,0,"remote001.tzo.net","dummy_username","dummy_password" OK |
| Test | AT+UDYNDNS=? | +UDYNDNS: (list of supported <on_off>),(list of supported <service_id>,<domain_name>,<username>,<password> OK | +UDYNDNS: (0-1),(0-4),"domain_name","username","password" OK |
| URC | | +UUDYNDNS: <status>,<code> | +UUDYNDNS: 1,0 |

18.2.4 Defined values

| Parameter | Type | Description |
|---------------|--------|--|
| <on_off> | Number | Enable / disable the dynamic DNS client: <ul style="list-style-type: none"> • 0 (factory-programmed value): disable the client • 1: enable the client |
| <service_id> | Number | Indicates which dynamic DNS service provider to use: <ul style="list-style-type: none"> • 0 (factory-programmed value): TZO.com • 1: DynDNS.org • 2: DynDNS.it • 3: No-IP.org • 4: DynamicDNS.org Mandatory parameter with <on_off>=1, not allowed with <on_off>=0. |
| <domain_name> | String | Indicates which domain name should be associated with the module IP address. The dynamic DNS service provider provides this value. Maximum length: 64 bytes. |

| Parameter | Type | Description |
|------------|--------|--|
| | | Mandatory parameter with <on_off>=1, not allowed with <on_off>=0. The factory-programmed value is an empty string. |
| <username> | String | The username used for the client authentication. Maximum length: 64 characters. Mandatory parameter with <on_off>=1, not allowed with <on_off>=0. The factory-programmed value is an empty string. |
| <password> | String | The password used for the client authentication. Maximum length: 32 characters. Mandatory parameter with <on_off>=1, not allowed with <on_off>=0. The factory-programmed value is an empty string. |
| <status> | Number | This is the internal status of the dynamic DNS client. Each time the internal status changes or there is an error the URC +UUDYNDNS is issued: <ul style="list-style-type: none"> • 0: client inactive/stopped • 1: client enabled/active • 2: DNS update successfully executed • 3: DNS update failed • 4: DNS update delayed • 5: No DNS update is required • 6: Self deactivation: the dynamic DNS client will stop due to internal error or DynDNS protocol specification |
| <code> | Number | This is the code returned by the +UUDYNDNS URC. The meaning of the <code> value is described in Dynamic DNS unsolicited indication codes (see Dynamic DNS unsolicited indication codes). |

18.2.5 Notes

- In case of self deactivation (+UUDYNDNS <status> = 6), the client is disabled (saving the disabled setting into the NVM); the customer has then to identify the cause (usually bad configuration of the client) and manually re-activate it. After a self deactivation it is always required to re-activate the client.
- If UDYNDNS is enabled and properly configured an +UUDYNDNS URC (+UUDYNDNS: 1,0) will be displayed at the "system power on" on AT terminal. The +UUDYNDNS URC (+UUDYNDNS: 1,0) notifies that the UDYNDNS service is enabled and that an dynamic IP address update will occur when an Internal PDP context will be activated or when an Internal PDP context IP address will change.

18.2.6 DynDNS client behavior in case of error

When the error result code is in range 1-10 and 100-108 the client waits for 60 s before allowing any update operation.

In all the other cases (error in range from 40 to 57) the following behaviors are applied:

- SARA-R422 / SARA-R422M8S / SARA-R422S - For TZO.com:

| DynDNS client error code | Provider error code | Client action |
|--------------------------|---------------------|---|
| 40 | 200 | Next update will be possible after 60 s |
| 41 | 304 | Next update will be possible after 10 minutes |
| 45 | 401 | Client self deactivation |
| 53 | 403 | Client self deactivation |
| 55 | 414 | Next update will be possible after 60 s |
| 46 | 405 | Client self deactivation |
| 54 | 407 | Client self deactivation |
| 56 | 415 | Client self deactivation |
| 57 | 480 | Next update will be possible after 24 hours |

- SARA-R422 / SARA-R422M8S / SARA-R422S - For DynDNS.org, DynDNS.it, No-IP.org and DNSDynamic.org:

| DynDNS client error code | Provider error code | Client action |
|--------------------------|---------------------|---|
| 40 | good | Next update will be possible after 60 s |
| 41 | nochg | Next update will be possible after 10 minutes |
| 45 | badauth | Next update will be possible after 24 hours |

| DynDNS client error code | Provider error code | Client action |
|---------------------------------|----------------------------|---|
| 47 | !donator | Next update will be possible after 24 hours |
| 42 | notfqdn | Client self deactivation |
| 43 | nohost | Client self deactivation |
| 44 | numhost | Client self deactivation |
| 48 | abuse | Client self deactivation |
| 46 | badagent | Client self deactivation |
| 49 | dnserr | Next update will be possible after 30 minutes |
| 50 | 911 | Next update will be possible after 30 minutes |
| 51 | badsys | Client self deactivation |
| 52 | lyours | Client self deactivation |

19 Internet protocol transport layer

19.1 Introduction



SARA-R4 / SARA-N4

Before using TCP/IP services, a connection profile must be defined and activated. The sockets can be managed independently and simultaneously over the same bearer (either PSD or CSD). AT commands for both reading and writing data on sockets are provided and the URC notifies the external application of incoming data and transmission result, no need for polling.



SARA-R410M / SARA-R412M / SARA-R422 / SARA-R422M8S / SARA-R422S / SARA-N4

See **+UPSD** AT command for CID mapping and **+CGACT** for activating a PDP context.



SARA-R4 / SARA-N4

When these commands report an error result code which is not a +CME ERROR, the error code can be queried using the **+USOER** or **+USOCTL** (specifying the socket ID and with <param_id>=1) AT commands.

The maximum number of sockets that can be managed depends on the module series:

- SARA-R4 / SARA-N4 - 7, where the secure sockets that can be managed are 4



SARA-R404M

No need to establish a PSD connection explicitly. This device automatically establishes a PSD connection as part of the network registration and attach procedure.



The UDP protocol has not any flow control mechanism and packets might be lost in the following scenarios:

- No network signal is available
- Unreliable radio interface (e.g. mobility in GPRS, where cell reselections can lead to data loss, that can be contrasted with the usage of LLC ack reliability QoS parameter)



SARA-R4 / SARA-N4

Some network operators close dynamic NATs after few minutes if there is no activity on the connection (no data transfer in the period). To solve this problem enable the TCP keep alive options with 1 minute delay (see the **+USOSO** AT command).



When both TCP and UDP socket are used at the same time at the maximum throughput (downlink and uplink at the maximum allowed baud rate) it is possible to lose some incoming UDP packets due to internal buffer limitation. A possible workaround is provided as follows:

- If it is possible, adopt an application layer UDP acknowledge system

19.2 IPv4/IPv6 addressing

19.2.1 Introduction

The section describes the IP addressing formats and IP address rules used by TCP/IP UDP/IP enabled applications.

19.2.2 IPv4

Format:

- 32 bits long in dot-decimal notation (without leading 0 notation).
- All the decimal numbers must be in range 0-255.
- The dot-octal notation is not supported.
- The dot-hexadecimal notation is not supported.

Examples:

| IPv4 address | Remarks |
|-----------------|--|
| 254.254.254.254 | Valid address |
| 010.228.76.34 | Invalid address; first decimal number prefixed with a leading zero |
| 257.228.76.34 | Invalid address; first decimal number greater than 255 |

| IPv4 address | Remarks |
|---------------------|--|
| 0010.0344.0114.0042 | Invalid address; dot-octal notation; decimals given as octal numbers |
| 0x10.0xE4.0x4C.0x22 | Invalid address; dot-hexadecimal notation; decimals given as hexadecimal numbers |

Table 28: IPv4 address format examples

19.2.3 IPv6

Format:

- 128 bits long represented in 8 groups of 16 bits each.
- The 16 bits of a group are represented as 2 concatenated hexadecimal numbers.
- The groups are separated by a colon character (:).
- The leading 0 in a group is supported.
- A group containing 4 zeros can be abbreviated with one 0.
- Continuous groups (at least 2) with zeroes can be replaced with a double colon (::).
- The double colon can appear only once in an IPv6 address.

Examples:

| IPv6 address | Remarks |
|---|--|
| 2001:0104:0000:0000:0000:0104:0000:0000 | Full version, with leading zeros |
| 2001:104:0000:0000:0000:104:0000:0000 | Abbreviated version, leading zero abbreviation |
| 2001:104:0:0:0:104:0:0 | Abbreviated version, zero group abbreviation |
| 2001:104::104:0:0 | Abbreviated version, one double colon abbreviation |

Table 29: IPv6 address format examples



The following AT commands support the IPv6 address format:

- Dynamic DNS update: **+UDYNDNS**
- Connect Socket: **+USOCO**
- SendTo command: **+USOST**
- Receive From command: **+USORF**
- Set Listening Socket: **+USOLI**
- IP Change Notification: **+UIPCHGN**
- FTP service configuration: **+UFTP**
- HTTP control: **+UHTTP**

For packet switched services AT commands (i.e. PDP_addr in +CGDCONT) the format is specified in the corresponding command section.

19.3 Create Socket +USOCR

| +USOCR | | | | | | |
|-------------------|---------------|---------------------|-----------------------|-----------------------|----------------------|----------------------------|
| Modules | All products | | | | | |
| Attributes | Syntax | PIN required | Settings saved | Can be aborted | Response time | Error reference |
| | partial | No | No | No | - | +CME Error |

19.3.1 Description

Creates a socket and associates it with the specified protocol (TCP or UDP), returns a number identifying the socket. Such command corresponds to the BSD socket routine:

- SARA-R4 / SARA-N4 - Up to 7 sockets can be created.

It is possible to specify the local port to bind within the socket in order to send data from a specific port. The bind functionality is supported for both TCP and UDP sockets.



The socket creation operation can be performed only after the PDP context activation on one of the defined profiles.

19.3.2 Syntax

| Type | Syntax | Response | Example |
|------|--|--|--------------------------------------|
| Set | AT+USOCR=<protocol>[,<local_port>[,<IP_type>]] | +USOCR: <socket> OK | AT+USOCR=17 +USOCR: 2 OK |
| Test | AT+USOCR=? | +USOCR: (list of supported <protocol>s),(list of supported <local_port>s),(list of supported <IP_type>s) OK | +USOCR: (6,17),(1-65535),(0,1) OK |

19.3.3 Defined values

| Parameter | Type | Description |
|--------------|--------|--|
| <protocol> | Number | <ul style="list-style-type: none"> 6: TCP 17: UDP |
| <local_port> | Number | Local port to be used while sending data. The range goes from 1 to 65535. If the parameter is omitted it will be set to 0; in this case a random port will be used while sending data. |
| <socket> | Number | Socket identifier to be used for any future operation on that socket. <ul style="list-style-type: none"> SARA-R4 / SARA-N4 - The range goes from 0 to 6. |
| <IP_type> | Number | Selects the specific IP type (for the required <socket>) between IPv4 and IPv6 when <PDP_type> is set to "IPV4V6" while the PDP context is created by means of +CGDCONT AT command. Allowed values: <ul style="list-style-type: none"> 0 (default value): IPv4 1: IPv6 |

19.3.4 Notes

SARA-R4 / SARA-N4

- The <local_port> parameter is not supported; a random local port will be used while sending data.
- The <IP_type> parameter is not supported.

19.4 SSL/TLS/DTLS mode configuration on TCP/UDP socket +USOSEC

| +USOSEC | | | | | | |
|-------------------|--|---------------------|-----------------------|-----------------------|----------------------|------------------------|
| Modules | SARA-R410M SARA-R412M SARA-R422M8S SARA-R422S SARA-N4 | | | | | |
| Attributes | Syntax | PIN required | Settings saved | Can be aborted | Response time | Error reference |
| | full | No | No | No | < 120 s | +CME Error |

19.4.1 Description

Enables or disables the use of SSL/TLS/DTLS connection (where supported) on a TCP/UDP socket. The configuration of the SSL/TLS/DTLS properties is provided with an SSL/TLS/DTLS profile managed by USECMNG.

The <usecmng_profile_id> parameter is listed in the information text response to the read command only if the SSL/TLS/DTLS is enabled on the interested socket.

- SARA-R410M-01B / SARA-R410M-02B / SARA-R410M-52B / SARA-R412M / SARA-N4
The command is applicable only with TCP sockets.
- The enable or disable operation can be performed only after the socket has been created with [+USOCR](#) AT command.
- The SSL/TLS/DTLS is supported only with [+USOCO](#) command (socket connect command). The SSL/TLS/DTLS is not supported with [+USOLI](#) command (socket set listen command is not supported and the [+USOSEC](#) settings will be ignored).

SARA-R4 / SARA-N4
Issue the command before the **+USOCO** AT command (socket connect command).

The command response time may vary depending on the module series. For more details, see the [Appendix B.4](#).

19.4.2 Syntax

| Type | Syntax | Response | Example |
|------|---|---|-------------------------------------|
| Set | AT+USOSEC=<socket>,<ssl_tls_dtls_status>[,<usecmng_profile_id>] | OK | AT+USOSEC=0,1,1 OK |
| Read | AT+USOSEC=<socket> | +USOSEC: <socket>,<ssl_tls_dtls_status>[,<usecmng_profile_id>] OK | AT+USOSEC=0 +USOSEC: 0,1,1 OK |
| Test | AT+USOSEC=? | +USOSEC: (list of supported <socket>s),(list of supported <ssl_tls_dtls_status>s),(list of supported <usecmng_profile_id>s) OK | +USOSEC: (0-6),(0,1),(0-4) OK |

19.4.3 Defined values

| Parameter | Type | Description |
|-----------------------|--------|---|
| <socket> | Number | Socket identifier defined by the AT+USOCR command. <ul style="list-style-type: none"> SARA-R4 / SARA-N4 - The range goes from 0 to 6. |
| <ssl_tls_dtls_status> | Number | <ul style="list-style-type: none"> 0 (default value): disable the SSL/TLS/DTLS on the socket. 1: enable the socket security; a USECMNG profile can be specified with the <usecmng_profile_id> parameter. |
| <usecmng_profile_id> | Number | Defines the USECMNG profile which specifies the SSL/TLS/DTLS properties to be used for the SSL/TLS/DTLS connection. The range goes from 0 to 4. If no profile is set a default USECMNG profile is used (see USECMNG section). |

19.5 Set socket option +USOSO

| +USOSO | | | | | | |
|------------|--------------|--------------|----------------|----------------|---------------|----------------------------|
| Modules | All products | | | | | |
| Attributes | Syntax | PIN required | Settings saved | Can be aborted | Response time | Error reference |
| | full | No | No | No | - | +CME Error |

19.5.1 Description

Sets the specified standard option (type of service, local address re-use, linger time, time-to-live, etc.) for the specified socket, like the BSD setsockopt routine.

Issue a set command to set each parameter.

19.5.2 Syntax

| Type | Syntax | Response | Example |
|------|---|--|---------------------------------|
| Set | AT+USOSO=<socket>,<level>,<opt_name>,<opt_val>[,<opt_val2>] | OK | AT+USOSO=2,6,1,1 OK |
| Test | AT+USOSO=? | +USOSO: (list of supported <socket>s),(list of supported <level>s) OK | +USOSO: (0-6),(0,6,65535) OK |

19.5.3 Defined values

| Parameter | Type | Description |
|-----------|--------|--------------------|
| <socket> | Number | Socket identifier. |

| Parameter | Type | Description |
|------------|--------|--|
| <level> | Number | <ul style="list-style-type: none"> SARA-R4 / SARA-N4 - The range goes from 0 to 6. Allowed values: <ul style="list-style-type: none"> 0: IP protocol <opt_name> for IP protocol level may be: <ul style="list-style-type: none"> 1: type of service (TOS) <opt_val>: 8 bitmask that represents the flags of IP TOS. The range is 0-255 (the default value is 0). For more information, see the RFC 791 [158] 2: time-to-live (TTL) <opt_val>: unsigned 8 bit value representing the TTL. The range is 0-255 (the default value is 255) 6: TCP protocol <opt_name> for TCP protocol level may be: <ul style="list-style-type: none"> 1: no delay option; do not delay send to coalesce packets; <opt_val>: numeric parameter, it enables/disables the "no delay" option: <ul style="list-style-type: none"> 0 (default value): disabled 1: enabled 2: keepidle option: send keepidle probes when it is idle for <opt_val> milliseconds <opt_val>: signed 32 bit numeric parameter representing the milliseconds for "keepidle" option. The range is 0-2147483647. The default value is 7200000 (2 hours) 65535: socket <opt_name> for socket level options may be: <ul style="list-style-type: none"> 4: local address re-use. <opt_val>: numeric parameter, it configures the "local address re-use" option. <ul style="list-style-type: none"> 0 (default value): disabled 1: enabled 8: keep connections alive. <opt_val>: numeric parameter, it configures "keep connections alive" option. <ul style="list-style-type: none"> 0 (default value): disabled 1: enabled 32: sending of broadcast messages. <opt_val>: numeric parameter, it configures "sending of broadcast messages". <ul style="list-style-type: none"> 0 (default value): disabled 1: enabled 128: linger on close if data present. <opt_val>: numeric parameter, it configures the "linger" option. <ul style="list-style-type: none"> 0 (default value): disabled 1: enabled <opt_val2>: signed 16 bit numeric parameter, it sets the linger time, the range goes from 0 to 32767 in milliseconds. The default value is 0. 512: local address and port re-use. <opt_val>: numeric parameter, it configures the "local address and port re-use". <ul style="list-style-type: none"> 0 (default value): disabled 1: enabled |
| <opt_name> | Number | Type and supported content depend on the related <level> parameter value (details are given above). |
| <opt_val> | Number | Type and supported content depend on the related <level> parameter value (details are given above). |
| <opt_val2> | Number | Type and supported content depend on the related <level> parameter value (details are given above). |

19.5.4 Notes

SARA-R4 / SARA-N4

- <level>=6 (TCP protocol), <opt_name>=2 (keepidle option) is not supported.
- <level>=65535 (socket), <opt_name>=32 (sending of broadcast messages) is not supported.
- <level>=65535 (socket), <opt_name>=512 (local address and port re-use) is not supported.

19.6 Get Socket Option +USOGO

| +USOGO | | | | | | |
|-------------------|---------------|---------------------|-----------------------|-----------------------|----------------------|------------------------|
| Modules | All products | | | | | |
| Attributes | Syntax | PIN required | Settings saved | Can be aborted | Response time | Error reference |
| | full | No | No | No | - | +CME Error |

19.6.1 Description

Retrieves the specified standard option (type of service, local address re-use, linger time, time-to-live, etc) for the specified socket, like the BSD getsockopt routine.

19.6.2 Syntax

| Type | Syntax | Response | Example |
|------|--------------------------------------|--|-------------------------------------|
| Set | AT+USOGO=<socket>,<level>,<opt_name> | +USOGO: <opt_val>[,<opt_val2>] OK | AT+USOGO=0,0,2 +USOGO: 255 OK |
| Test | AT+USOGO=? | +USOGO: (list of supported <socket>s),(list of supported <level>s) OK | +USOGO: (0-6),(0,6,65535) OK |

19.6.3 Defined values

| Parameter | Type | Description |
|-----------|--------|---|
| <socket> | Number | Socket identifier. <ul style="list-style-type: none"> SARA-R4 / SARA-N4 - The range goes from 0 to 6. |
| <level> | Number | <ul style="list-style-type: none"> 0: IP Protocol <opt_name> for IP protocol level may be: <ul style="list-style-type: none"> 1: type of service <opt_val>: 8 bit mask that represents the flags of IP TOS. For more information see the RFC 791 [158]. The range is 0-255. The default value is 0 2: time-to-live <opt_val>: unsigned 8 bit value representing the TTL. The range is 0-255. The default value is 0. 6: TCP Protocol <opt_name> for TCP protocol level may be: <ul style="list-style-type: none"> 1: no delay option: do not delay send to coalesce packets <opt_val>: numeric parameter, it enables/disables the "no delay" option <ul style="list-style-type: none"> 0 (default value): disabled 1: enabled 2: keepidle option: send keepidle probes when idle for <opt_val> milliseconds <opt_val>: signed 32 bit number value representing the milliseconds for "keepidle" option. The range 0-2147483647. The default value is 7200000 (2 hours) 65535: socket <opt_name> for the socket level options may be: <ul style="list-style-type: none"> 4: local address re-use <opt_val>: numeric parameter, it configures the "local address re-use" option: <ul style="list-style-type: none"> 0 (default value): disabled 1: enabled 8: keep connections alive <opt_val>: numeric parameter, it configures the "keep connections alive" option: <ul style="list-style-type: none"> 0 (default value): disabled 1: enabled 32: sending of broadcast messages <opt_val>: numeric parameter, it configures the "sending of broadcast messages": <ul style="list-style-type: none"> 1: enabled |

| Parameter | Type | Description |
|-----------|------|--|
| | | <ul style="list-style-type: none"> - 0 (default value): disabled o 128: linger on close if data present <opt_val>: numeric parameter, it sets on/off the "linger" option. - 0 (default value): disabled - 1: enabled <opt_val2>: signed 16 bit numeric value, linger time, the range goes from 0 to 32767 in milliseconds. The default value is 0. |
| | | <ul style="list-style-type: none"> o 512: local address and port re-use <opt_val>: numeric parameter, it enables/disables "local address and port re-use": - 0 (default value): disabled - 1: enabled |

19.6.4 Notes

SARA-R4 / SARA-N4

- The setting <level>= 6 (TCP protocol) and <opt_name>= 2 (keepidle option) is not supported.
- <level>=65535 (socket), <opt_name>=32 (sending of broadcast messages) is not supported.
- <level>=65535 (socket), <opt_name>=512 (local address and port re-use) is not supported.

19.7 Close Socket +USOCL

| +USOCL | | | | | | |
|-------------------|---------------|---------------------|-----------------------|-----------------------|----------------------|------------------------|
| Modules | All products | | | | | |
| Attributes | Syntax | PIN required | Settings saved | Can be aborted | Response time | Error reference |
| | partial | No | No | No | < 120 s | +CME Error |

19.7.1 Description

Closes the specified socket, like the BSD close routine. In case of remote socket closure the user is notified via the URC.

By default the command blocks the AT command interface until the the completion of the socket close operation. By enabling the <async_close> flag, the final result code is sent immediately. The following +UUSOCL URC will indicate the closure of the specified socket.



The command response time may vary depending on the module series. For more details, see the [Appendix B.4](#).

19.7.2 Syntax

| Type | Syntax | Response | Example |
|------|-----------------------------------|---|---------------------------|
| Set | AT+USOCL=<socket>[,<async_close>] | OK | AT+USOCL=2 OK |
| Test | AT+USOCL=? | +USOCL: (list of supported <socket>s) OK | +USOCL: (0-6),(0-1) OK |
| URC | | +UUSOCL: <socket> | +UUSOCL: 2 |

19.7.3 Defined values

| Parameter | Type | Description |
|---------------|--------|---|
| <socket> | Number | Socket identifier. <ul style="list-style-type: none"> • SARA-R4 / SARA-N4 - The range goes from 0 to 6. |
| <async_close> | Number | Asynchronous close flag. The flag has effect for TCP connections only. Allowed values: <ul style="list-style-type: none"> • 0 (default value): the operation result is returned only once the result of the TCP close becomes available, locking the AT interface until the connection closes. • 1: the final result code is returned immediately unlocking the AT interface and making it available for the execution of other AT commands. Once the result of TCP |

| Parameter | Type | Description |
|-----------|------|--|
| | | close becomes available, it is notified to the AT interface through the +UUSOCL URC. |

19.7.4 Notes

SARA-R404M / SARA-R410M-01B

- The <async_close> parameter is not supported.

19.8 Get Socket Error +USOER

| +USOER | | | | | | |
|------------|--------------|--------------|----------------|----------------|---------------|---|
| Modules | All products | | | | | |
| Attributes | Syntax | PIN required | Settings saved | Can be aborted | Response time | Error reference |
| | full | No | No | No | - | TCP/UDP/IP Error +CME Error |

19.8.1 Description

Retrieves the last error occurred in the last socket operation, stored in the BSD standard variable error.

19.8.2 Syntax

| Type | Syntax | Response | Example |
|--------|----------|------------------------------|-------------------|
| Action | AT+USOER | +USOER: <socket_error> OK | +USOER: 104 OK |

19.8.3 Defined values

| Parameter | Type | Description |
|----------------|--------|--|
| <socket_error> | Number | Code of the last error occurred in a socket operation. The allowed values are listed in Appendix A.6 <ul style="list-style-type: none"> 0: no error |

19.9 Connect Socket +USOCO

| +USOCO | | | | | | |
|------------|--------------|--------------|----------------|----------------|---------------|----------------------------|
| Modules | All products | | | | | |
| Attributes | Syntax | PIN required | Settings saved | Can be aborted | Response time | Error reference |
| | partial | No | No | No | < 130 s | +CME Error |

19.9.1 Description

Establishes a peer-to-peer connection of the socket to the specified remote host on the given remote port, like the BSD connect routine. If the socket is a TCP socket, the command will actually perform the TCP negotiation (3-way handshake) to open a connection. If the socket is a UDP socket, this function will just declare the remote host address and port for later use with other socket operations (e.g. +USOWR, +USORD). This is important to note because if <socket> refers to a UDP socket, errors will not be reported prior to an attempt to write or read data on the socket.



The estimated response time depends also by the DNS resolution. For further details about the estimated response time related to the DNS resolution, see the [+UDNSRN](#) AT command.

19.9.2 Syntax

| Type | Syntax | Response | Example |
|------|---|----------|--|
| Set | AT+USOCO=<socket>,<remote_addr>,<remote_port>[,<async_connect>] | OK | AT+USOCO=3,"151.63.16.9",1200 OK AT+USOCO=2,"151.63.16.9",8200,1 |

| Type | Syntax | Response | Example |
|------|------------|---|---|
| | | | OK +UUSOCO: 2,0 AT+USOCO=2,"151.63.16.9",8230,0 |
| Test | AT+USOCO=? | +USOCO: (list of supported <socket>s),"remote_host",(list of supported <remote_port>s),(list of supported <async_connect>s) OK | +USOCO: (0-6),"remote_host",(1-65535),(0-1) OK |
| URC | | +UUSOCO: <socket>,<socket_error> | +UUSOCO: 2,0 |

19.9.3 Defined values

| Parameter | Type | Description |
|-----------------|--------|---|
| <socket> | Number | Socket identifier to be used for any future operation on that socket. <ul style="list-style-type: none"> SARA-R4 / SARA-N4 - The range goes from 0 to 6. |
| <remote_addr> | String | Remote host IP address or domain name of the remote host. For IP address format reference see the IP addressing . |
| <remote_port> | Number | Remote host port, in range 1-65535 |
| <async_connect> | Number | Asynchronous connect flag. The flag has effect for TCP connections only. Allowed values: <ul style="list-style-type: none"> 0 (default value): the operation result is returned only once the TCP connection is established, locking the AT interface until the connection activity is running 1: the final result code is returned immediately unlocking the AT interface and making it available for the execution of other AT commands. Once the result of TCP connection becomes available, it is notified to the AT interface through the +UUSOCO URC. |
| <socket_error> | Number | Code of the last error occurred in a socket operation. The allowed values are listed in Appendix A.6 : <ul style="list-style-type: none"> 0: no error, connection successful |

19.9.4 Notes

- In case of the socket connection with the asynchronous flag:
 - the socket will be closed if a further +USOCO AT command is issued before having received the +UUSOCO URC of the first AT command.
 - it is not possible to connect a second socket before the reception of the +UUSOCO URC related to the pending socket connection.

SARA-R404M / SARA-R410M-01B

- The <async_connect> parameter and the +UUSOCO URC are not available.

19.10 Write socket data +USOWR

| +USOWR | | | | | | |
|------------|--------------|--------------|----------------|----------------|---------------|-----------------|
| Modules | All products | | | | | |
| Attributes | Syntax | PIN required | Settings saved | Can be aborted | Response time | Error reference |
| | partial | No | No | No | < 120 s | +CME Error |

19.10.1 Description

Writes the specified amount of data to the specified socket, like the BSD write routine, and returns the number of bytes of data actually written. The command applies to UDP sockets too, after a +USOCO command.

There are three kinds of syntax:

- Base syntax normal: writing simple strings to the socket, some characters are forbidden
- Base syntax HEX: writing hexadecimal strings to the socket, the string will be converted in binary data and sent to the socket; see the [AT+UDCONF=1](#) command description to enable it

- Binary extended syntax: mandatory for writing any character in the ASCII range [0x00, 0xFF]



Some notes about the **TCP socket**:

- If no network signal is available, the TCP packets are enqueued until the network will become available again. If the TCP queue is full the +USOWR command will return an error result code. To get the last socket error use the +USOCTL=1 command. If the error code returned is 11, it means that the queue is full.
- If the connection is closed by the remote host, the +UUSOCL URC is not sent until all received data is read using the AT+USORD command. If AT+USOWR command is used in this situation, an error result code is returned. See also the [Notes](#) section about the specific product behavior
- If the connection is closed by the remote host and binary interface started with AT+USOWR command is still waiting for data, an error result code is returned indicating that the binary interface was closed. After the error result code a +UUSOCL URC is reported indicating that the socket was closed.



Some notes about the **UDP socket**:

- Due to the UDP specific AT commands, it is preferred to use the +USOST command to send data via UDP socket. This command does not require the usage of +USOCO before sending data.
- If no network signal is available, out going UDP packet may be lost.



The information text response indicates that data has been sent to lower level of protocol stack. This is not an indication of an acknowledgment received by the remote server the socket is connected to.



The command response time may vary depending on the module series. For more details, see the [Appendix B.4](#).

19.10.2 Syntax

| Type | Syntax | Response | Example |
|----------------------|-----------------------------------|---|---|
| Base syntax | | | |
| Set | AT+USOWR=<socket>,<length>,<data> | +USOWR: <socket>,<length> OK | AT+USOWR=3,12,"Hello world!" +USOWR: 3,12 OK |
| Binary syntax | | | |
| Set | AT+USOWR=<socket>,<length> | @<data> +USOWR: <socket>,<length> OK | AT+USOWR=3,16 @16 bytes of data +USOWR: 3,16 OK |
| Test | AT+USOWR=? | +USOWR: (list of supported <socket>s),(list of supported <length>s),"HEX data" +USOWR: (list of supported <socket>s),(list of supported <length>s),"data" +USOWR: (list of supported <socket>s),(list of supported <length>s) OK | +USOWR: (0-6),(0-512),"HEX data" +USOWR: (0-6),(0-1024),"data" +USOWR: (0-6),(0-1024) OK |

19.10.3 Defined values

| Parameter | Type | Description |
|-----------|--------|---|
| <socket> | Number | Socket identifier. <ul style="list-style-type: none"> • SARA-R4 / SARA-N4 - The range goes from 0 to 6. |
| <length> | Number | Number of data bytes to write: <ul style="list-style-type: none"> • Base syntax normal mode: range 1-1024 • Base syntax HEX mode: range 1-512 • Binary extended syntax: range 1-1024 |
| <data> | String | Data bytes to be written. Not all of the ASCII charset can be used. |

19.10.4 Notes

- For base syntax:
 - The value of <length> and the actual length of <data> must match
- For base syntax HEX mode:
 - Only the ASCII characters 0-9, A-F and a-f are allowed.
 - The length of the <data> parameter must be two times the <length> parameter.
- For binary syntax:
 - After the command is sent, the user waits for the @ prompt. When it appears the stream of bytes can be provided. After the specified amount of bytes has been sent, the system provides the final result code. The feed process cannot be interrupted i.e. the return in the command mode can be effective only when the number of bytes provided is the declared one.
 - After the @ prompt reception, wait for a minimum of 50 ms before sending data.
 - The binary extended syntax is the only way for the system to accept control characters as data; for the AT command specifications 3GPP TS 27.005 [69], characters like <CR>, <CTRL-Z>, quotation marks, etc. have a specific meaning and they cannot be used like data in the command itself. The command is so extended with a specific acceptance state identified by the @ prompt.
 - This feature can be successfully used when there is need to send a byte stream which belongs to a protocol that has any kind of characters in the ASCII range [0x00,0xFF].
 - In binary mode the module does not display the echo of data bytes.
 - Binary syntax is not affected by HEX mode option.
- For <data> parameter not all of the ASCII charset can be used.

SARA-R4 / SARA-N4

- In the information text response to the set command +USOWR: <socket>,<length>, the <length> parameter may not match with the value of the set command due to data segmentation. In this case, use the [AT+USOCTL=1](#) command to get the number of bytes that were sent. If not all intended bytes are sent then send the remaining bytes using the +USOWR AT command.

19.11 SendTo command (UDP only) +USOST

| +USOST | | | | | | |
|-------------------|---------------|---------------------|-----------------------|-----------------------|----------------------|------------------------|
| Modules | All products | | | | | |
| Attributes | Syntax | PIN required | Settings saved | Can be aborted | Response time | Error reference |
| | full | No | No | No | < 130 s | +CME Error |

19.11.1 Description

Writes the specified amount of data to the remote address, like the BSD sendto routine, and returns the number of bytes of data actually written. It can be applied to UDP sockets only. This command allows the reuse of the same socket to send data to many different remote hosts.

There are three kinds of syntax:

- **Base syntax normal:** writing simple strings to the socket, there are characters which are forbidden.
- **Base syntax HEX:** writing hexadecimal strings to the socket, the string will be converted in binary data and sent to the socket. To enable it, see the [AT+UDCONF=1](#) command description.
- **Binary extended syntax:** mandatory for writing any character in the ASCII range [0x00, 0xFF].



It is strongly recommended using this command to send data while using UDP sockets. It is also recommended avoiding the [+USOCO](#) AT command usage with UDP socket.



If no network signal is available, outgoing UDP packet may be lost.



The information text response to the test command provides the information about the binary extended syntax only where supported.



The command response time may vary depending on the module series. For more details, see the [Appendix B.4](#).



In binary mode the command will never return if less characters than the expected length are issued after the prompt.

19.11.2 Syntax

| Type | Syntax | Response | Example |
|----------------------|---|--|---|
| Base syntax | | | |
| Set | AT+USOST=<socket>,<remote_addr>,<remote_port>,<length>,<data>,[<seq_no>] | +USOST: <socket>,<length> OK | AT+USOST=3,"151.9.34.66",449,16,"16 bytes of data" +USOST: 3,16 OK |
| Binary syntax | | | |
| Set | AT+USOST=<socket>,<remote_addr>,<remote_port>,<length> After the "@" prompt <length> bytes of data are entered | @<data> +USOST: <socket>,<length> OK | AT+USOST=3,"151.9.34.66",449,16@16 bytes of data +USOST: 3,16 OK |
| Test | AT+USOST=? | +USOST: (list of supported <socket>s),"remote_host",(list of supported <remote_port>s),(list of supported <length>s),(list of supported <seq_no>s),"HEX data" +USOST: (list of supported <socket>s),"remote_host",(list of supported <remote_port>s),(list of supported <length>s),(list of supported <seq_no>s),"data" [+USOST: (list of supported <socket>s),"remote_host",(list of supported <remote_port>s),(list of supported <length>s)] OK | +USOST: (1-8),"remote_host",(1-65535),(1-512),(1-255),"HEX data" +USOST: (1-8),"remote_host",(1-65535),(1-1024),(1-255),"data" OK |
| URC | | +UUSOST: <socket>,<seq_no>,<UDP_result> | +USOST: 3,1,1 |

19.11.3 Defined values

| Parameter | Type | Description |
|---------------|--------|--|
| <socket> | Number | Socket identifier. <ul style="list-style-type: none"> SARA-R4 / SARA-N4 - The range goes from 0 to 6. |
| <remote_addr> | String | Remote host IP address or domain name of the remote host. For IP address format reference, see the IP addressing . |
| <remote_port> | Number | Remote host port, in range 1-65535 |
| <length> | Number | Number of data bytes to write: <ul style="list-style-type: none"> SARA-R4 / SARA-N4 <ul style="list-style-type: none"> Base syntax normal mode: range 1-1024 Base syntax HEX mode: range 1-512 Binary syntax mode: range 1-1024 |
| <data> | String | Data bytes to be written (not all of the ASCII charset can be used) |
| <seq_no> | Number | Sequence number of UDP packet, in range 1-255. The default value is 1. |
| <UDP_result> | Number | Supported values: <ul style="list-style-type: none"> 0: fail 1: success |

19.11.4 Notes

- For base syntax:
 - The value of <length> and the actual length of <data> must match
 - For base syntax HEX mode, only ASCII characters 0-9, A-F and a-f are allowed. The length of the <data> parameter must be two times the <length> parameter
- For binary syntax:

- o After the command is sent, the user waits for the @ prompt. When it appears the stream of bytes can be provided. After the specified amount of bytes has been sent, the system returns with final result code. The feed process cannot be interrupted i.e. the return in the command mode can be effective only when the number of bytes provided is the declared one
- o That binary extended syntax is the only way for the system to accept control characters as data; for the AT command specifications [69], characters like <CR>, <CTRL-Z>, quotation marks, etc. have a specific meaning and they cannot be used like data in the command itself. The command is so extended with a specific acceptance state identified by the @ prompt
- o This feature can be successfully used when there is need to send a byte stream which belongs to a protocol that has any kind of characters in the ASCII range [0x00,0xFF]
- o In binary mode the module does not display the echo of data bytes
- o Binary syntax is not affected by HEX mode option
- o In binary mode the command response time value specified in [Estimated command response time](#) takes effect after the last expected character has been issued

SARA-R404M / SARA-R410M / SARA-R412M / SARA-R422 / SARA-N4

- The <seq_no> parameter and the +UUSOST URC are not supported.

SARA-R422M8S / SARA-R422S

- The <seq_no> parameter and the +UUSOST URC are not supported.
- The +USOST AT command should not be used for a DTLS connection, that is when the connection has been configured using the +USOCO and the +USOSEC AT commands. For DTLS connections the +USOCO, +USOSEC, +USORD and +USOWR AT commands need to be used.

19.12 Read Socket Data +USORD

| +USORD | | | | | | |
|------------|--------------|--------------|----------------|----------------|--------------------|-----------------|
| Modules | All products | | | | | |
| Attributes | Syntax | PIN required | Settings saved | Can be aborted | Response time | Error reference |
| | full | No | No | No | < 1 s (except URC) | +CME Error |





19.12.1 Description

Reads the specified amount of data from the specified socket, like the BSD read routine. This command can be used to know the total amount of unread data.

For the TCP socket type the URC **+UUSORD: <socket>, <length>** notifies the data bytes available for reading, either when buffer is empty and new data arrives or after a partial read by the user.

For the UDP socket type the URC **+UUSORD: <socket>, <length>** notifies that a UDP packet has been received, either when buffer is empty or after a UDP packet has been read and one or more packets are stored in the buffer.

In case of a partial read of a UDP packet **+UUSORD: <socket>, <length>** will show the remaining number of data bytes of the packet the user is reading.

-  If the UART interface of the application processor has a RX FIFO of only 1 character, it is highly recommended to set the <length> parameter lower than 64.
-  (about UDP socket) Due to the UDP specific AT command, it is preferred to use the +USORF command to read data from UDP socket. +USORF command does not require the usage of +USOCO before reading data.
-  When applied to UDP active sockets if the UDP socket is not set in listening mode (see +USOLI) it will not be possible to receive any packet if a previous write operation is not performed.
-  If the HEX mode is enabled (refer to AT+UDCONF=1 command) the received data will be displayed using an hexadecimal string.
-  SARA-R4 / SARA-N4
For the UDP socket type, only the +UUSORF URC is issued to notify that a UDP packet has been received, either when buffer is empty or after a UDP packet has been read and one or more packets are stored in the buffer.

19.12.2 Syntax

| Type | Syntax | Response | Example |
|------|----------------------------|---|--|
| Set | AT+USORD=<socket>,<length> | +USORD: <socket>,<length>,<data in the ASCII [0x00,0xFF] range> OK | AT+USORD=3,16 +USORD: 3,16,"16 bytes of data" OK |
| Test | AT+USORD=? | +USORD: (list of supported <socket>s),(list of supported <length>s) OK | +USORD: (0-6),(0-1024) OK |
| URC | | +UUSORD: <socket>,<length> | +UUSORD: 3,16 |

19.12.3 Defined values

| Parameter | Type | Description |
|-----------|--------|--|
| <socket> | Number | Socket identifier. <ul style="list-style-type: none"> SARA-R4 / SARA-N4 - The range goes from 0 to 6. |
| <length> | Number | Number of data bytes <ul style="list-style-type: none"> to read stored in buffer, in range 0-1024 in the set command read from buffer, in range 0-1024 stored in buffer for the URC |
| <data> | String | Data bytes to be read |

19.12.4 Notes

- The returned data may be any ASCII character in the range [0x00,0xFF] i.e. control characters. The starting quotation marks shall not be taken into account like data; the first byte of data starts after the first quotation marks. Then the other characters are provided for a <length> amount. An application should rely on the <length> info to count the received number of characters (after the starting quotation marks) especially if any protocol control characters are expected.
- If an application deals with letter and number characters only i.e. all of the expected characters are outside the [0x00, 0x1F] range and are not quotation marks, the AT+USORD response quotation marks can be assumed to identify the start and the end of the received data packet. Always check <length> to identify the valid data stream.
- If the number of data bytes requested to be read from the buffer is bigger than the number of bytes stored in the buffer only the available amount of data bytes will be read.
- When <length>= 0, the command returns the total amount of data present in the network buffer.
Example: 23 unread bytes in the socket.

```
AT+USORD=3,0
+USORD: 3,23
OK
```

- If the HEX mode is enabled, the length of <data> will be 2 times <length>.

SARA-R4 / SARA-N4

- In case there are no bytes returned or available, the <length> parameter is omitted in the information text response to the set command.
Example: information text response does not have any length information.

```
AT+USORD=0,7
+USORD: 0,""
OK
```



19.13 Receive From command (UDP only) +USORF

| +USORF | | | | | | |
|------------|--------------|--------------|----------------|----------------|--------------------|-----------------|
| Modules | All products | | | | | |
| Attributes | Syntax | PIN required | Settings saved | Can be aborted | Response time | Error reference |
| | full | No | No | No | < 1 s (except URC) | +CME Error |

19.13.1 Description

Reads the specified amount of data from the specified UDP socket, like the BSD `recvfrom` routine. The URC **+UUSORF: <socket>,<length>** (or also **+UUSORD: <socket>,<length>**) notifies that new data is available for reading, either when new data arrives or after a partial read by the user for the socket. This command can also return the total amount of unread data.

This command can be applied to UDP sockets only, and it can be used to read data after both **+UUSORD** and **+UUSORF** unsolicited indication.

-  If the HEX mode is enabled (see **+UDCONF=1**) the received data will be displayed using an hexadecimal string.
-  SARA-R4 / SARA-N4
For the UDP socket type, only the **+UUSORF** URC is issued to notify that a UDP packet has been received, either when buffer is empty or after a UDP packet has been read and one or more packets are stored in the buffer.

19.13.2 Syntax

| Type | Syntax | Response | Example |
|------|----------------------------|--|---|
| Set | AT+USORF=<socket>,<length> | +USORF: <socket>,<remote_ip_addr>,<remote_port>,<length>,<data in the ASCII [0x00,0xFF] range> OK | AT+USORF=3,16 +USORF: 3,"151.9.34.66",2222,16,"16 bytes of data" OK |
| Test | AT+USORF=? | +USORF: (list of supported <socket>s),(list of supported <length>s) OK | +USORF: (0-6),(0-1024) OK |
| URC | | +UUSORF: <socket>,<length> | +UUSORF: 3,16 |

19.13.3 Defined values

| Parameter | Type | Description |
|------------------|--------|--|
| <socket> | Number | Socket identifier. <ul style="list-style-type: none"> • SARA-R4 / SARA-N4 - The range goes from 0 to 6. |
| <remote_ip_addr> | String | Remote host IP address. For IP address format reference see the IP addressing . |
| <remote_port> | Number | Remote host port, in range 1-65535 |
| <length> | Number | Number of data bytes to read stored in buffer (if in the set command), or read from the buffer (if in the information text response to the set command), or stored in the buffer (for the URC). The allowed range when issued in the set command or returned in the information text response is: <ul style="list-style-type: none"> • SARA-R4 / SARA-N4 - 0-1024 |
| <data> | String | Data bytes to be read |

19.13.4 Notes

- Each packet received from the network is stored in a separate buffer and the command is capable to read only a packet (or a portion of it) at time. This means that if <length> is greater than the packet size, the command will return a maximum amount of data equal to the packet size, also if there are other packets in the buffer. The remaining data (i.e. the remaining UDP packets) can be read with further reads.
- The returned data may have any kind of ASCII character in the range [0x00,0xFF] i.e. control characters too. The starting quotation marks shall not be taken into account like data; the first byte of data starts

after the first quotation marks. Then the other characters are provided for a <length> amount. At the end of the length byte stream, another quotation marks followed by <CR><LF> are provided for user convenience and visualization purposes. An application should rely on the <length> info to count the received number of characters (after the starting quotation marks) especially if any protocol control characters are expected.

- If an application deals with letter and number characters only i.e. all of the expected characters are outside the [0x00, 0x1F] range and are not quotation marks, the [AT+USORD](#) response quotation marks can be assumed to identify the start and the end of the received data packet, anyway the <length> field usage to identify the valid data stream is recommended.
- When <length>= 0, the command returns the total amount of data present in the network buffer.
Example: 23 unread bytes in the socket.

```
AT+USORF=3,0
+USORF: 3,23
OK
```

- If the HEX mode is enabled, the length of <data> will be 2 times <length>.

SARA-R4 / SARA-N4

- In case there are no bytes returned or available, the <length> parameter is omitted in the information text response to the set command.

SARA-R422M8S / SARA-R422S

- The +USORF AT command should not be used for a DTLS connection, that is when the connection has been configured using the [+USOCO](#) and the [+USOSEC](#) AT commands. For DTLS connections the [+USOCO](#), [+USOSEC](#), [+USORD](#) and [+USOWR](#) AT commands need to be used.

SARA-R410M-02B / SARA-R412M

- On SARA-R410M-02B-00, SARA-R410M-02B-01, SARA-R410M-02B-02, SARA-R412M-02B-00, SARA-R412M-02B-01, SARA-R412M-02B-02 each received packet can be read in a maximum of two portions; unread data that were not included in the 2 portions are discarded.

SARA-R404M / SARA-R410M-01B / SARA-R410M-52B / SARA-N4

- Each received packet can be read in a maximum of two portions; unread data that were not included in the 2 portions are discarded.

19.14 Set Listening Socket +USOLI

| +USOLI | | | | | | |
|------------|--------------|--------------|----------------|----------------|--------------------|-----------------|
| Modules | All products | | | | | |
| Attributes | Syntax | PIN required | Settings saved | Can be aborted | Response time | Error reference |
| | full | No | No | No | < 1 s (except URC) | +CME Error |

19.14.1 Description

Sets the specified socket in listening mode on the specified port of service, waiting for incoming connections (TCP) or data (UDP):

- For **TCP sockets**, incoming connections will be automatically accepted and notified via the URC **+UUSOLI: <socket>,<ip_address>,<port>,<listening_socket>,<local_ip_address>,<listening_port>**, carrying the connected socket identifier, the remote IP address and port.
- For **UDP sockets**, incoming data will be notified via URC **+UUSORF: <listening_socket>,<length>**. To know from which remote IP address and port the data is coming from, use the [AT+USORF](#) command.

19.14.2 Syntax

| Type | Syntax | Response | Example |
|------|--------------------------|----------|---|
| Set | AT+USOLI=<socket>,<port> | OK | TCP sockets AT+USOLI=2,1200 OK |

| Type | Syntax | Response | Example |
|--------------|------------|--|---|
| | | | +UUSOLI: 3,"151.63.16.7",1403,2, "82.89.67.164",1200 UDP sockets AT+USOLI=0,1182 OK +UUSORF: 0,1024 |
| Test | AT+USOLI=? | +USOLI: (list of supported <socket>s),(list of supported <port>s) OK | +USOLI: (0-6),(1-65535) OK |
| URC (TCP) | | +UUSOLI: <socket>,<ip_address>, <port>,<listening_socket>,<local_ ip_address>,<listening_port> | +UUSOLI: 3,"151.63.16.7",1403,0, "82.89.67.164",200 |
| URC (UDP) | | +UUSORF: <listening_socket>, <length> | +UUSORF: 1,967 |

19.14.3 Defined values

| Parameter | Type | Description |
|--------------------|--------|---|
| <socket> | Number | Socket identifier. <ul style="list-style-type: none"> SARA-R4 / SARA-N4 - The range goes from 0 to 6. |
| <port> | Number | Port of service, range 1-65535. Port numbers below 1024 are not recommended since they are usually reserved |
| <ip_address> | String | Remote host IP address (only in URC +UUSOLI). For IP address format reference see the IP addressing . |
| <listening_socket> | Number | Socket identifier specified within the AT+USOLI command, indicates on which listening socket the connection has been accepted (only in +UUSOLI URC) |
| <local_ip_address> | String | TE IP address (only in +UUSOLI URC). For IP address format reference see the IP addressing . |
| <listening_port> | Number | Listening port that has accepted the connection. This port is specified within the AT +USOLI command (only in +UUSOLI URC) |
| <length> | Number | Data length received on the UDP listening socket (only in +UUSORF unsolicited indication). In order to know the sender IP address and port, use the AT+USORF command. |

19.14.4 Notes

- In case of notification via the URC +UUSOLI <port> is intended as the remote port.

19.15 HEX mode configuration +UDCONF=1

| +UDCONF=1 | | | | | | |
|------------|--------------|--------------|----------------|----------------|---------------|----------------------------|
| Modules | All products | | | | | |
| Attributes | Syntax | PIN required | Settings saved | Can be aborted | Response time | Error reference |
| | full | No | No | No | - | +CME Error |

19.15.1 Description

Enables/disables the HEX mode for [+USOWR](#), [+USOST](#), [+USORD](#) and [+USORF](#) AT commands.

19.15.2 Syntax

| Type | Syntax | Response | Example |
|------|-------------------------------|------------------------------------|-----------------------------------|
| Set | AT+UDCONF=1,<enable_hex_mode> | OK | AT+UDCONF=1,0 OK |
| Read | AT+UDCONF=1 | +UDCONF: 1,<enable_hex_mode> OK | AT+UDCONF=1 +UDCONF: 1,1 OK |

19.15.3 Defined values

| Parameter | Type | Description |
|-------------------|--------|---|
| <enable_hex_mode> | Number | Enables/disables the HEX mode for +USOWR , +USOST , +USORD and +USORF AT commands. Allowed values: <ul style="list-style-type: none"> 0 (factory-programmed value): HEX mode disabled 1: HEX mode enabled |







19.16 Set socket in Direct Link mode **+USODL**

| +USODL | | | | | | |
|---------------|--------------|--------------|----------------|----------------|---------------|-----------------|
| Modules | All products | | | | | |
| Attributes | Syntax | PIN required | Settings saved | Can be aborted | Response time | Error reference |
| | full | No | No | No | < 1 s | +CME Error |

19.16.1 Description

Establishes a transparent end-to-end communication with an already connected TCP or UDP socket via the serial interface. The data can be sent to the socket and can be received via the serial interface: the HW flow control usage is strongly recommended to avoid data loss.

The transparent TCP/UDP connection mode can be exited via the +++ sequence, entered after at least 2 s of suspension of transmission to the port. The socket will remain connected and communication can be re-established any time.

-  SARA-R404M / SARA-R410M / SARA-R412M / SARA-N4
When in direct link mode the last entered character is "+", the module holds the character in the buffer and waits for further input. If further input completes the "+++" sequence, the module exits direct link mode. Otherwise, if the entered data do not complete the "+++" sequence, the module transmits them normally.
-  SARA-R410M-02B / SARA-R410M-63B / SARA-R410M-73B / SARA-R410M-83B / SARA-R412M / SARA-R422 / SARA-R422M8S / SARA-R422S
The **+UDCONF=5**, **+UDCONF=6**, **+UDCONF=7**, **+UDCONF=8** commands allow the configuration of UDP and TCP direct link triggers.
-  SARA-R404M / SARA-R410M-01B / SARA-R410M-52B / SARA-N4
The **+UDCONF=5**, **+UDCONF=6**, **+UDCONF=7** commands allow the configuration of UDP and TCP direct link triggers.
-  When using Direct Link with UDP sockets, if no network signal is available, outgoing UDP packet may be lost.
-  SARA-R404M / SARA-R410M-01B
The HW flow control is not supported.
-  SARA-R410M-02B
The HW flow control is not supported by SARA-R410M-02B-00.

19.16.2 Syntax

| Type | Syntax | Response | Example |
|------|-------------------|---|-----------------------|
| Set | AT+USODL=<socket> | CONNECT | AT+USODL=0 CONNECT |
| Test | AT+USODL=? | +USODL: (list of supported <socket>s) OK | +USODL: (0-6) OK |

19.16.3 Defined values

| Parameter | Type | Description |
|-----------|--------|--|
| <socket> | Number | Socket identifier. <ul style="list-style-type: none"> SARA-R4 / SARA-N4 - The range goes from 0 to 6. |

19.16.4 Enhanced Direct Link

The enhanced DL functionality allows the user set up to three kinds of trigger for data transmission:

- Timer Trigger
- Data Length Trigger
- Character Trigger

The triggers can be applied independently to each socket. A socket may be set with more than one trigger.

The trigger must be set after the socket creation and before switching to direct link mode.

By default Timer Trigger and Data Length Trigger are enabled for UDP sockets.

By default no triggers are enabled for TCP sockets.

 SARA-R410M-02B / SARA-R410M-63B / SARA-R410M-73B / SARA-R410M-83B / SARA-R412M / SARA-R422 / SARA-R422M8S / SARA-R422S

See the `+UDCONF=5`, `+UDCONF=6`, `+UDCONF=7`, `+UDCONF=8` commands description for the transmission triggers configuration.

 SARA-R404M / SARA-R410M-01B / SARA-R410M-52B / SARA-N4

See the `+UDCONF=5`, `+UDCONF=6`, `+UDCONF=7` commands description for the transmission triggers configuration.

19.16.4.1 Timer Trigger (TT)

The user can configure a timeout for sending the data. The timer starts every time a character is read from the serial interface. When the timer expires, buffered data is sent.

The timer range is between 100 and 120000 ms.

 SARA-R4 / SARA-N4

The special value 0 (zero) means that the timer is disabled. By default the timer trigger is enabled with a value of 1000 ms TCP sockets and enabled with a value of 500 ms for UDP sockets.

The `+UDCONF=5` command can configure the timer trigger.

19.16.4.2 Data Length Trigger (DLT)

The user can configure a maximum buffered data length to reach before sending the data. When this length is reached the data is sent.

The minimum data length is 3, the maximum data length is 2048 bytes for TCP and 1472 bytes for UDP.

 SARA-R4 / SARA-N4

If the data length is set to 0 (zero) the trigger is disabled. By default the data length trigger is disabled for TCP sockets and set to 1024 for UDP sockets.

If both the timer trigger and the data length trigger are both set to 0, the effective DLT size is 2048 bytes for TCP sockets and 1472 bytes for UDP sockets.

The `+UDCONF=6` command can configure the data length trigger.

19.16.4.3 Character Trigger (CT)

The user can configure a character that will trigger the data transmission. When the character is detected the data (including the trigger character) is sent.

If the specified character is -1, the character trigger is disabled.

By default it is disabled for both TCP and UDP sockets.

The `+UDCONF=7` command can configure the character trigger.

19.16.4.4 Combined Triggers

The user can enable multiple triggers together. The triggers work with an OR logic. This means that the first trigger reached fires the data transmission.

19.16.4.5 About serial data chunks

A data chunk is the amount of data that SIO recognizes as a single data transmission.

If the baud rate is lower than 115200 b/s the time to receive 255 characters is always calculated with timings for 115200 b/s.

19.16.4.6 Data from the network

The data received from the network is immediately forwarded to the serial interface.

19.16.4.7 Congestion timer

The congestion timer represents the time after which, in case of network congestion, the module exits from direct link.

- SARA-R410M-02B / SARA-R410M-63B / SARA-R410M-73B / SARA-R410M-83B / SARA-R412M / SARA-R422 / SARA-R422M8S / SARA-R422S - The timer range is between 1000 and 720000 ms, the special value 0 (zero) means that the timer is disabled. By default the congestion timer is set to 60000 (60 s) for both TCP and UDP sockets. The **+UDCONF=8** command can configure the congestion timer.
- SARA-R404M / SARA-R410M-01B / SARA-R410M-52B / SARA-N4 - For TCP socket it is 30 s. The value varies depending on network behavior. For UDP socket case the congestion timer is not used.

SARA-R410M-02B / SARA-R412M
 The **+UDCONF=8** AT command is not supported by SARA-R410M-02B-00, SARA-R410M-02B-01, SARA-R410M-02B-02, SARA-R412M-02B-00, SARA-R412M-02B-01, SARA-R412M-02B-02; for TCP socket the congestion timer is 30 s. The value varies depending on network behavior. For UDP socket case the congestion timer is not used.

19.17 UDP Direct Link Packet Size configuration +UDCONF=2

| +UDCONF=2 | | | | | | |
|------------|--------------|--------------|----------------|----------------|---------------|-----------------|
| Modules | All products | | | | | |
| Attributes | Syntax | PIN required | Settings saved | Can be aborted | Response time | Error reference |
| | full | No | No | No | - | +CME Error |

19.17.1 Description

Set the packet size for the UDP direct link packet.

19.17.2 Syntax

| Type | Syntax | Response | Example |
|------|---------------------------------------|--|--|
| Set | AT+UDCONF=2,<socket_id>,<packet_size> | OK | AT+UDCONF=2,1,1024 OK |
| Read | AT+UDCONF=2,<socket_id> | +UDCONF: 2,<socket_id>,<packet_size> OK | AT+UDCONF=2,1 +UDCONF: 2,1,1024 OK |

19.17.3 Defined values

| Parameter | Type | Description |
|---------------|--------|---|
| <socket_id> | Number | Socket identifier; used when changing the UDP Direct Link settings: <ul style="list-style-type: none"> • SARA-R4 / SARA-N4 - The range goes from 0 to 6. |
| <packet_size> | Number | Packet size (in bytes) for UDP direct link; valid range is 100-1472; the factory-programmed value is 1024 bytes |

19.18 UDP Direct Link Sending timer configuration +UDCONF=3

| +UDCONF=3 | | | | | | |
|------------|--------------|--------------|----------------|----------------|---------------|----------------------------|
| Modules | All products | | | | | |
| Attributes | Syntax | PIN required | Settings saved | Can be aborted | Response time | Error reference |
| | full | No | No | No | - | +CME Error |

19.18.1 Description

Configures the UDP direct link set sending timer.

19.18.2 Syntax

| Type | Syntax | Response | Example |
|------|---|--|--|
| Set | AT+UDCONF=3,<socket_id>,<sending_timer_timeout> | OK | AT+UDCONF=3,1,1000 OK |
| Read | AT+UDCONF=3,<socket_id> | +UDCONF: 3,<socket_id>,<sending_timer_timeout> OK | AT+UDCONF=3,1 +UDCONF: 3,1,1000 OK |

19.18.3 Defined values

| Parameter | Type | Description |
|-------------------------|--------|---|
| <socket_id> | Number | Socket identifier; used when changing the UDP Direct Link settings: <ul style="list-style-type: none"> SARA-R4 / SARA-N4 - The range goes from 0 to 6. |
| <sending_timer_timeout> | Number | Sending timer (in milliseconds) for UDP direct link; valid range is 100-120000; the default value is 1000 ms |

19.19 Timer Trigger configuration for Direct Link +UDCONF=5

| +UDCONF=5 | | | | | | |
|------------|--------------|--------------|----------------|----------------|---------------|----------------------------|
| Modules | All products | | | | | |
| Attributes | Syntax | PIN required | Settings saved | Can be aborted | Response time | Error reference |
| | full | No | No | No | - | +CME Error |

19.19.1 Description

Sets the timer trigger of the interested socket identifier for the data transmission enhanced Direct Link.

19.19.2 Syntax

| Type | Syntax | Response | Example |
|------|---|--|---|
| Set | AT+UDCONF=5,<socket_id>,<timer_trigger> | OK | AT+UDCONF=5,0,500 OK |
| Read | AT+UDCONF=5,<socket_id> | +UDCONF: 5,<socket_id>,<timer_trigger> OK | AT+UDCONF=5,0 +UDCONF: 5,0,500 OK |

19.19.3 Defined values

| Parameter | Type | Description |
|-----------------|--------|---|
| <socket_id> | Number | Socket identifier; used when changing the UDP Direct Link settings: <ul style="list-style-type: none"> SARA-R4 / SARA-N4 - The range goes from 0 to 6. |
| <timer_trigger> | Number | Enhanced Direct Link sending timer trigger (in milliseconds); valid range is 0 (trigger disabled), 100-120000; <ul style="list-style-type: none"> SARA-R4 / SARA-N4 - the factory-programmed value is 500 ms for UDP, 1000 ms for TCP. |

19.20 Data Length Trigger configuration for Direct Link +UDCONF=6

| +UDCONF=6 | | | | | | |
|------------|--------------|--------------|----------------|----------------|---------------|----------------------------|
| Modules | All products | | | | | |
| Attributes | Syntax | PIN required | Settings saved | Can be aborted | Response time | Error reference |
| | full | No | No | No | - | +CME Error |

19.20.1 Description

Sets the data length trigger of the interested socket identifier for the data transmission enhanced Direct Link.



SARA-R4 / SARA-N4

If data length trigger (<data_length_trigger>) and timer trigger (see [+UDCONF=5](#)) are both set to 0, the effective data length trigger size is 2048 bytes for TCP sockets and 1472 bytes for UDP sockets.

19.20.2 Syntax

| Type | Syntax | Response | Example |
|------|---|--|--|
| Set | AT+UDCONF=6,<socket_id>,<data_length_trigger> | OK | AT+UDCONF=6,0,1024 OK |
| Read | AT+UDCONF=6,<socket_id> | +UDCONF: 6,<socket_id>,<data_length_trigger> OK | AT+UDCONF=6,0 +UDCONF: 6,0,1024 OK |

19.20.3 Defined values

| Parameter | Type | Description |
|-----------------------|--------|---|
| <socket_id> | Number | Socket identifier; used when changing the UDP Direct Link settings: <ul style="list-style-type: none"> SARA-R4 / SARA-N4 - The range goes from 0 to 6. |
| <data_length_trigger> | Number | Enhanced Direct Link data length trigger in bytes, valid range is 0, 3-1472 for UDP and 0, 3-2048 for TCP, the factory-programmed value is 1024 for UDP, 0 for TCP, 0 means trigger disabled. |

19.21 Character trigger configuration for Direct Link +UDCONF=7

| +UDCONF=7 | | | | | | |
|------------|--------------|--------------|----------------|----------------|---------------|----------------------------|
| Modules | All products | | | | | |
| Attributes | Syntax | PIN required | Settings saved | Can be aborted | Response time | Error reference |
| | full | No | No | No | - | +CME Error |

19.21.1 Description

Sets the character trigger of the interested socket identifier for the data transmission enhanced Direct Link.

19.21.2 Syntax

| Type | Syntax | Response | Example |
|------|---|--|--|
| Set | AT+UDCONF=7,<socket_id>,<character_trigger> | OK | AT+UDCONF=7,0,13 OK |
| Read | AT+UDCONF=7,<socket_id> | +UDCONF: 7,<socket_id>,<character_trigger> OK | AT+UDCONF=7,0 +UDCONF: 7,0,13 OK |

19.21.3 Defined values

| Parameter | Type | Description |
|---------------------|--------|---|
| <socket_id> | Number | Socket identifier; used when changing the Direct Link settings: <ul style="list-style-type: none"> SARA-R4 / SARA-N4 - The range goes from 0 to 6. |
| <character_trigger> | Number | Enhanced Direct Link character trigger, the value represents the ASCII code (in base 10) of the character to be used as character trigger. The allowed range is -1, 0-255, the factory-programmed value is -1; -1 means trigger disabled. |

19.22 Congestion timer configuration for Direct Link +UDCONF=8

| +UDCONF=8 | | | | | | |
|------------|--|--------------|----------------|----------------|---------------|----------------------------|
| Modules | SARA-R410M-02B SARA-R410M-63B SARA-R410M-73B SARA-R410M-83B SARA-R412M SARA-R422 SARA-R422M8S SARA-R422S | | | | | |
| Attributes | Syntax | PIN required | Settings saved | Can be aborted | Response time | Error reference |
| | full | No | No | No | - | +CME Error |

19.22.1 Description

Sets the congestion timer of the interested socket identifier for the data transmission enhanced Direct Link.

19.22.2 Syntax

| Type | Syntax | Response | Example |
|------|--|---|--|
| Set | AT+UDCONF=8,<socket_id>,<congestion_timer> | OK | AT+UDCONF=8,0,120000 OK |
| Read | AT+UDCONF=8,<socket_id> | +UDCONF: 8,<socket_id>,<congestion_timer> OK | AT+UDCONF=8,0 +UDCONF: 8,0,120000 OK |

19.22.3 Defined values

| Parameter | Type | Description |
|--------------------|--------|--|
| <socket_id> | Number | Socket identifier; used when changing the Direct Link settings. Valid range is 0-6 |
| <congestion_timer> | Number | Enhanced Direct Link congestion timer (in milliseconds); valid range is 0, 1000-72000 0; the factory-programmed value is 60000, 0 means trigger disabled |

19.22.4 Notes

SARA-R410M-02B / SARA-R412M

- The command is not supported by SARA-R410M-02B-00, SARA-R410M-02B-01, SARA-R410M-02B-02, SARA-R412M-02B-00, SARA-R412M-02B-01, SARA-R412M-02B-02.

19.23 Internal IP stack congestion configuration +UDCONF=18

| +UDCONF=18 | | | | | | |
|------------|-----------------------------------|--------------|----------------|----------------|---------------|----------------------------|
| Modules | SARA-R422 SARA-R422M8S SARA-R422S | | | | | |
| Attributes | Syntax | PIN required | Settings saved | Can be aborted | Response time | Error reference |
| | full | No | NVM | No | - | +CME Error |

19.23.1 Description

Configures the flow control for the internal IP stack, which applies to socket-related, embedded TCP/IP application related AT commands (e.g. FTP, MQTT). The command has no effect on DUN/PPP traffic.



Reboot the module (e.g. by means of [AT+CFUN=15](#) command) to make the change effective.

19.23.2 Syntax

| Type | Syntax | Response | Example |
|------|------------------------------|-------------------------------|----------------------|
| Set | AT+UDCONF=18,<conf_handling> | OK | AT+UDCONF=18,0 OK |
| Read | AT+UDCONF=18 | AT+UDCONF: 18,<conf_handling> | +UDCONF: 18,0 OK |

19.23.3 Defined values

| Parameter | Type | Description |
|-----------------|--------|--|
| <conf_handling> | Number | Flow control configuration for the internal IP stack. Allowed values: <ul style="list-style-type: none"> 0 (factory-programmed value): lossy, no flow control applied, packets will be dropped in case of congestion at protocol stack 1: non-lossy, input rate reduction via flow control in order not to drop any packet |

19.24 Direct Link disconnect DSR line handling +UDCONF=10

| +UDCONF=10 | | | | | | |
|------------|--------------|--------------|----------------|----------------|---------------|-----------------|
| Modules | All products | | | | | |
| Attributes | Syntax | PIN required | Settings saved | Can be aborted | Response time | Error reference |
| | full | No | No | No | - | +CME Error |

19.24.1 Description

The Direct Link functionality changes the DSR line state according to the **&S** configuration. If the **&S** configuration = 1 (default and factory programmed value), DSR line transitions will occur as follows:

- From LOW to HIGH when the module enters into Direct Link mode
- From HIGH to LOW when the module exits from Direct Link mode

The +UDCONF=10 command allows to configure the behaviour of the DSR line when the module exits from Direct Link. In fact, the transition (from HIGH to LOW) can be configured to occur prior to or after the output of the "<CR><LF>DISCONNECT<CR><LF>" string.

This command has no effect when the **&S** configuration = 0.

19.24.2 Syntax

| Type | Syntax | Response | Example |
|------|--------------------------------------|---|-------------------------------------|
| Set | AT+UDCONF=10,<dl_dsr_line_behaviour> | OK | AT+UDCONF=10,1 OK |
| Read | AT+UDCONF=10 | +UDCONF: 10,<dl_dsr_line_behaviour> OK | AT+UDCONF=10 +UDCONF: 10,1 OK |

19.24.3 Defined values

| Parameter | Type | Description |
|-------------------------|--------|--|
| <dl_dsr_line_behaviour> | Number | Behaviour of the DSR transition when the module exits from Direct Link. Allowed values: <ul style="list-style-type: none"> 0 (default value): DSR line transition (HIGH to LOW) is performed after the output of the "<CR><LF>DISCONNECT<CR><LF>" string 1: DSR line transition (HIGH to LOW) is performed before (~20 ms) the output of the "<CR><LF>DISCONNECT<CR><LF>" string |

19.25 Socket control +USOCTL

| +USOCTL | | | | | | |
|-------------------|---------------|---------------------|-----------------------|-----------------------|----------------------|------------------------|
| Modules | All products | | | | | |
| Attributes | Syntax | PIN required | Settings saved | Can be aborted | Response time | Error reference |
| | partial | No | No | No | - | +CME Error |

19.25.1 Description

Allows interaction with the low level socket layer.

19.25.2 Syntax

| Type | Syntax | Response | Example |
|------|-------------------------------|--|--|
| Set | AT+USOCTL=<socket>,<param_id> | +USOCTL: <socket>,<param_id>,<param_val>[,<param_val2>] OK | AT+USOCTL=0,2 +USOCTL: 0,2,38 OK |
| Test | AT+USOCTL=? | +USOCTL: (list of supported <socket>s),(list of supported <param_id>s) OK | +USOCTL: (0-6),(0-4,10-11) OK |

19.25.3 Defined values

| Parameter | Type | Description |
|-------------|-----------------|--|
| <socket> | Number | Socket identifier. <ul style="list-style-type: none"> SARA-R4 / SARA-N4 - The range goes from 0 to 6. |
| <param_id> | Number | Control request identifier. Possible values are: <ul style="list-style-type: none"> 0: query for socket type 1: query for last socket error 2: get the total amount of bytes sent from the socket 3: get the total amount of bytes received by the socket 4: query for remote peer IP address and port 10: query for TCP socket status (only TCP sockets) 11: query for TCP outgoing unacknowledged data (only TCP sockets) 5-9, 12-99: RFU |
| <param_val> | Number / String | This value may assume different means depending on the <param_id> parameter. <p>If <param_id>=0, <param_val> can assume these values:</p> <ul style="list-style-type: none"> 6 TCP socket 17: UDP socket <p>If <param_id>=1, <param_val> can assume these values:</p> <ul style="list-style-type: none"> N: last socket error <p>If <param_id>=2, <param_val> can assume these values:</p> <ul style="list-style-type: none"> N: the total amount (in bytes) of sent (acknowledged + unacknowledged) data <p>If <param_id>=3, <param_val> can assume these values:</p> <ul style="list-style-type: none"> N: the total amount (in bytes) of received (read) data <p>If <param_id>=4, <param_val> can assume these values:</p> <ul style="list-style-type: none"> A string representing the remote peer IP address expressed in dotted decimal form <p>If <param_id>=10, <param_val> can assume these values:</p> <ul style="list-style-type: none"> 0: the socket is in INACTIVE status (it corresponds to CLOSED status defined in RFC793 "TCP Protocol Specification" [165]) 1: the socket is in LISTEN status 2: the socket is in SYN_SENT status 3: the socket is in SYN_RCVD status 4: the socket is in ESTABLISHED status 5: the socket is in FIN_WAIT_1 status 6: the socket is in FIN_WAIT_2 status |

| Parameter | Type | Description |
|--------------|--------|---|
| | | <ul style="list-style-type: none"> 7: the socket is in CLOSE_WAIT status 8: the socket is in CLOSING status 9: the socket is in LAST_ACK status 10: the socket is in TIME_WAIT status <p>If <param_id>=11, <param_val> can assume these values:</p> <ul style="list-style-type: none"> N: the total amount of outgoing unacknowledged data |
| <param_val2> | Number | This value is present only when <param_id> is 4. It represents the remote peer IP port. For IP address format reference see the IP addressing . |

19.25.4 Notes

SARA-R4 / SARA-N4

- <param_id>=4 is not supported.
- For TCP socket if <param_id>=2, the <param_val> parameter returns the total amount (in bytes) of sent acknowledged data.

SARA-R422 / SARA-R422M8S / SARA-R422S

- <param_id>=11 is supported for not secure connections (+USOSEC AT command has not been used with the same <socket>).

SARA-R410M-02B

- <param_id>=2, 3 and 11 are not supported by SARA-R410M-02B-00.

SARA-R404M / SARA-R410M-01B

- <param_id>=2, 3 and 11 are not supported.

SARA-N4

- <param_id>=11 is not supported.

19.26 IP Change Notification +UIPCHGN

| +UIPCHGN | | | | | | |
|------------|-------------------------|--------------|----------------|----------------|---------------|-----------------|
| Modules | SARA-R422M8S SARA-R422S | | | | | |
| Attributes | Syntax | PIN required | Settings saved | Can be aborted | Response time | Error reference |
| | full | No | NVM | No | - | +CME Error |

19.26.1 Description

Enable, disables or forces the IP change notification (CN) functionality. This command only works for internal PDP context activation.



SARA-R422M8S / SARA-R422S

See +UPSD AT command for CID mapping and +CGACT AT command for the PDP context activation. The IP CN feature only works for PDP context mapped by +UPSD AT command.

The IP CN notifies a remote server about changes in the module IP address.

The following information is delivered to the destination server:

- Current IP address of the module
- IMEI of the module (optional)
- IMSI of the inserted SIM card (optional)
- Username (optional)
- MD5 hash of user password (hex format) (optional)
- Custom information (up to 128 bytes)

The notification is sent via a HTTP GET request.

The GET request format is the following:

```
GET /<path>?myip=<ip>&imei=<imei>&imsi=<imsi>&user=<username>&pass=<md5passwd>&cust=<cust_info> HTTP/1.0{CRLF}
Host: <domain_name>{CRLF}
User-Agent: u-blox IP Change Notification Agent 1.0{CRLF}
{CRLF}
```

<ip>, <imei> (if enabled) and <imsi> (if enabled) fields inside the HTTP request are automatically inserted by the module, <domain_name>, <path>, <username>, <password> and <cust_info> fields must be provided by the application through the +UIPCHGN AT command.

{CRLF} is a placeholder for hexadecimal character 0x0D (CR) and 0x0A (LF).

The HTTP response from the server is parsed to recognize the HTTP response code and the text between the <ipchgn_r> and the </ipchgn_r> tags inside the response body. This text is not mandatory and can be freely customized by the customer (up to 64 printable characters).

A real world example follows:

Request (from the module)

```
GET /modemipnotify.php?myip=123.56.214.2&imei=992237050009739&imsi=992105301545971&user=test_user&pass=16ec1ebb01fe02ded9b7d5447d3dfc65&cust=Product%3A+Tracker+v.1.0 HTTP/1.0{CRLF}
Host: somedomain.com {CRLF}
User-Agent: u-blox IP Change Notification Agent 1.0{CRLF}
{CRLF}
```

Where

| Field | Content | Comment |
|-----------|----------------------------------|--|
| server | somedomain.com | Specified via +UIPCHGN AT command |
| path | modemipnotify.php | Specified via +UIPCHGN AT command |
| myip | 123.56.214.2 | |
| imei | 992237050009739 | |
| imsi | 992105301545971 | |
| user | test_user | Specified via +UIPCHGN AT command |
| pass | 16ec1ebb01fe02ded9b7d5447d3dfc65 | MD5 hash of "test_password"Specified via +UIPCHGN AT command |
| cust_info | Product%3A+Tracker+v.1.0 | URL encoding of the string "Product: Tracker v.1.0". Specified via +UIPCHGN AT command |

Response (from the server)

```
HTTP/1.0 200 OK {CRLF}
Content-Type: text/html {CRLF}
Content-Length: 31 {CRLF}
Connection: close {CRLF}
{CRLF}
<ipchgn_r>IP_UPDATED</ipchgn_r>
```

Another real world example (without custom information, username and password):

```
GET /modemipnotify.php?myip=123.56.214.2&imei=992237050009739&imsi=992105301545971&user=&pass=&cust=
HTTP/1.0{CRLF}

Host: somedomain.com {CRLF}

User-Agent: u-blox IP Change Notification Agent 1.0{CRLF}

{CRLF}
```

Where:

| Field | Content | Comment |
|-----------|-------------------|---------|
| server | somedomain.com | |
| path | modemipnotify.php | |
| myip | 123.56.214.2 | |
| imei | 992237050009739 | |
| imsi | 992105301545971 | |
| user | | (empty) |
| pass | | (empty) |
| cust_info | | (empty) |

Response (from the server)

```
HTTP/1.0 200 OK {CRLF}

Content-Type: text/html {CRLF}

Content-Length: 31 {CRLF}

Connection: close {CRLF}

{CRLF}

<ipchgn_r>IP_UPDATED</ipchgn_r>
```



Password hashing and URL encoding are performed by the module, so parameters < password> and <cust_info> must be inserted in plain text in the +UIPCHGN command (See command parameters below).

The command configuration is stored in the NVM; if enabled, the command automatically works after a reboot and the +UIPCHGN: 0 URC is sent to all terminals in this case.

If the IP CN feature is enabled, the notification is performed at each PDP context activation. If the client is enabled when a PDP connection is already active, it starts to update IP address on the next PDP context activation.



The custom information field (< cust_info >) is URL encoded into the HTTP request, this means that the final custom information inside the HTTP GET request may be longer than 128 bytes.



The username and password are not compulsory, but it is encouraged to use them for security reasons.

19.26.2 Syntax

| Type | Syntax | Response | Example |
|------|--|----------|---|
| Set | AT+UIPCHGN=<action>[,<server>,<port>,<path>,<send_imei>,<send_imsi>,<username>,<password>,<cust_info>] | OK | To enable the IP CN feature: AT+UIPCHGN=1,"somedomain.com",80,"modemipnotify.php",1,1,"test_user","test_password","Product: Tracker v.1.0" OK To force another IP CN to the remote server (CN must be previously enabled): AT+UIPCHGN=2 OK |

| Type | Syntax | Response | Example |
|------|--------------|---|---|
| | | | To disable the IP CN feature: AT+UIPCHGN=0 OK |
| Read | AT+UIPCHGN? | +UIPCHGN: <status>[,<server>,<port>,<path>,<send_imei>,<send_imsi>,<username>,<password>,<cust_info>] OK | +UIPCHGN: 1,"somedomain.com",80,"/modemipnotify.php",1,1,"test_user","test_password","Product: Tracker v.1.0" OK |
| Test | AT+UIPCHGN=? | +UIPCHGN: (list of supported <action>s),<server>,(list of supported <port>s),<path>,(list of supported <send_imei>s), (list of supported <send_imsi>s), <username>,<password>,<cust_info> OK | +UIPCHGN: (0 2),"server",(1 65535),"path",(0 1),(0 1),"username","password","cust_info" OK |
| URC | | +UUIPCHGN: <code>[,<reply_str>] | +UUIPCHGN: 200,"IP_UPDATED" |

19.26.3 Defined values

| Parameter | Type | Description |
|-------------|--------|---|
| <action> | Number | Disable / Enable / Force the Update of IP CN feature <ul style="list-style-type: none"> 0 (factory-programmed value): disable the feature 1: enable the feature 2: force IP notification update Note: < action > = 2 could be used when the +UUIPCHGN URC returns a code different from 200. |
| <server> | String | Indicates the remote host to which the HTTP GET request must be sent to notify the IP change event. It can be either a domain name (e.g. "somedomain.com") or an IP address in numeric format (e.g. "173.194.35.145"), always between double quotes. Maximum length: 64 characters Mandatory parameter with < action>=1, ignored with < action>=0 or < action>=2 |
| <port> | Number | Indicates the server port to which the HTTP GET request must be sent. Valid range: from 1 to 65535 Mandatory parameter with < action> =1, ignored with < action> =0 or < action> =2 |
| <path> | String | Indicates the server path to be used inside the HTTP GET request. The insertion of the starting "/" is not mandatory (the software automatically adds it if omitted). The string must be enclosed between double quotes. Maximum length: 64 characters Mandatory parameter with < action> =1, ignored with < action> =0 or < action> =2 |
| <username> | String | Indicates the username to be sent inside the HTTP request. The string must be enclosed between double quotes. Max length: 64 characters Mandatory parameter with < action> =1, ignored with < action> =0 or < action> =2 If no username is required, this parameter must be inserted as empty string ("") |
| <send_imei> | Number | Indicates if the notification must send the modem IMEI inside the notification HTTP GET request <ul style="list-style-type: none"> 0: do not send IMEI 1: send IMEI Mandatory parameter with < action> =1, ignored with < action> =0 or < action> =2 |
| <send_imsi> | Number | Indicates if the notification must send the modem IMSI inside the notification HTTP GET request Valid range: 0-1 <ul style="list-style-type: none"> 0: do not send IMSI |

| Parameter | Type | Description |
|-------------|--------|--|
| | | <ul style="list-style-type: none"> 1: send IMSI Mandatory parameter with <action>=1, ignored with <action>=0 or <action>=2 |
| <password> | String | Indicates the password whose MD5 hash is to be sent inside the HTTP request. The string must be enclosed between double quotes. Maximum length: 32 characters Mandatory parameter with <action>=1, ignored with <action>=0 or <action>=2 If no password is required, this parameter must be inserted as empty string ("") |
| <cust_info> | String | Indicates the custom information to send inside the HTTP GET request. The string must be enclosed between double quotes. Maximum length: 128 characters Mandatory parameter with <action>=1, ignored with <action>=0 or <action>=2 If no custom information is required, this parameter must be inserted as empty string ("") |
| <status> | Number | This value indicates the status of the IP CN feature <ul style="list-style-type: none"> 0: disabled 1: enabled |
| <code> | Number | This is the code returned by the +UUIPCHGN URC. Values lower than 100 should be interpreted as internal error, see UUIPGHGN Error . <code> values greater than 100 must be interpreted as HTTP server response code. If error is not present the code returned by the +UUIPCHGN should be 200. The +UUIPCHGN: 0 URC is sent to all terminals at boot if the IP CN feature is enabled from a previous working session. |
| <reply_str> | String | This is the text inserted between the <ipchgn_r> and </ipchgn_r> tags into the response body from the server. The string is enclosed between double quotes. The maximum length of this string is 64 bytes; if the server sends a longer string, it will be truncated. The parameter is only provided when the information is present in the HTTP response from the remote server and not if an internal error occurred. |

19.27 Configure Dormant Close Socket Behavior +USOCLCFG

| +USOCLCFG | | | | | | |
|-------------------|---|---------------------|-----------------------|-----------------------|----------------------|------------------------|
| Modules | SARA-R410M-02B SARA-R410M-52B SARA-R410M-63B SARA-R410M-73B SARA-R410M-83B SARA-R412M SARA-R422 SARA-R422M8S SARA-R422S SARA-N4 | | | | | |
| Attributes | Syntax | PIN required | Settings saved | Can be aborted | Response time | Error reference |
| | full | Yes | NVM | No | - | +CME Error |

19.27.1 Description

Enables or disables the TCP socket Graceful Dormant Close feature. When enabled, if the RRC connection is released and a TCP socket is closed with the +USOCL, the module will re-establish the RRC connection to close the socket both locally and remotely. When this feature is disabled, the module will close the socket locally without re-establishing the RRC connection. In this case the socket will remain open on the remote side until it is closed.

19.27.2 Syntax

| Type | Syntax | Response | Example |
|------|--------------------------|--|------------------------|
| Set | AT+USOCLCFG=<GDC_enable> | OK | AT+USOCLCFG=0 OK |
| Read | AT+USOCLCFG? | +USOCLCFG: <GDC_enable> OK | +USOCLCFG: 0 OK |
| Test | AT+USOCLCFG=? | +USOCLCFG: (list of supported <GDC_enable>s) OK | +USOCLCFG: (0,1) OK |

| Type | Syntax | Response | Example |
|------|--------|----------|---------|
| | | OK | |

19.27.3 Defined values

| Parameter | Type | Description |
|--------------|--------|--|
| <GDC_enable> | Number | Status of TCP socket Graceful Dormant Close. Allowed values: <ul style="list-style-type: none">• 0: disabled• 1 (factory-programmed value): enabled |

20 Device and data security

20.1 Introduction

Nowadays the security is very important to secure personal or confidential data from unauthorized access and therefore it is important to secure the IoT devices to protect the business and the data.

In the IoT security, a weak point is a defect which is called a vulnerability and it may become a safety issue; IoT devices connects/links physical objects and so in IoT it is needed to secure of course data traffic and networks but also the network of "things" or physical objects (i.e. medical devices, infrastructure, utility meters, vehicles, etc.) must be secured.

Some definitions are needed to understand the foundations of security:

- **Integrity** is about making sure that some pieces of data have not been altered from some "reference version".
- **Authentication** is about making sure that a given entity (with whom you are interacting) is who the user believes it to be.
- **Authenticity** is a special case of integrity, where the "reference version" is defined as "whatever it was when it was under control of a specific entity".
- **Confidentiality** means no unauthorized access to data (i.e. encryption/cryptography).

The u-blox security solution lets secure the IoT devices from end-to-end:

- **Device security**, the privacy of data is protected from the devices to the cloud (confidentiality, integrity and authenticity).
- **Data security**, the devices are protected from attack, they can be trusted and controlled (identity, authenticity and firmware protection).
- **Access Management**, it can be controlled who has access to data and products (device policies, data policies and feature authorization)

The pillars of the u-blox security are:

- **Unique device identity**, an immutable chip ID and a robust Root-of-Trust (RoT) provides the foundational security.
- **Secure boot sequence and updates**, only authenticated and authorized firmware and updates can run on the device.
- **Hardware-backed crypto functions**, a Secure Client Library (SCL) generates keys and crypto functions to securely connect to the cloud.

The IoT device is secured through different steps:

- **Provision trust**: insert Root-of-Trust at production. An immutable chip ID and hardware-based Root-of-Trust provide foundational security and a unique device identity.
- **Leverage trust**: derive trusted keys. Secure libraries allow generation of hardware-backed crypto functions and keys that securely connect to the cloud.
- **Guarantee trust**: use keys to secure any function. It ensures authenticity, integrity, and confidentiality to maintain control of device and data.

20.2 Device security

20.2.1 Introduction

These AT commands maintain device integrity over the entire lifecycle.

- The **+USECCHIP** AT command queries the immutable chip ID.
- The **+USECDEVINFO** AT command allows customer programming the device profile UID into each device along with their own device serial number.
- The **+USECROTUID** AT command queries the Root of Trust (RoT) public Unique IDentifier (UID).



SARA-R410M-63B / SARA-R410M-73B / SARA-R410M-83B

On SARA-R410M-63B-01, SARA-R410M-73B-01 and SARA-R410M-83B-01 the **+USECMODE** AT command configures the secure data suite features on the module if it has not been sealed with the **+USECDEVINFO** AT command.



SARA-R410M-63B / SARA-R410M-73B / SARA-R410M-83B

On SARA-R410M-63B-00, SARA-R410M-73B-00 and SARA-R410M-83B-00 the **+USECOFF** AT command disables the secure data suite features on the module if it has not been sealed with the **+USECDEVINFO** AT command.

20.2.2 Read the module chip ID +USECCHIP

| +USECCHIP | | | | | | |
|-------------------|--|---------------------|-----------------------|-----------------------|----------------------|------------------------|
| Modules | SARA-R410M-63B SARA-R410M-73B SARA-R410M-83B SARA-R422 SARA-R422M8S SARA-R422S | | | | | |
| Attributes | Syntax | PIN required | Settings saved | Can be aborted | Response time | Error reference |
| | full | No | No | No | - | +CME Error |

20.2.2.1 Description

Queries the chip ID of the module and returns it.

20.2.2.2 Syntax

| Type | Syntax | Response | Example |
|--------|-------------|----------------------------|-----------------------------|
| Action | AT+USECCHIP | +USECCHIP: <chip_id> OK | +USECCHIP: "12345678" OK |

20.2.2.3 Defined values

| Parameter | Type | Description |
|-----------|--------|------------------------|
| <chip_id> | String | Chip ID of the module. |

20.2.3 Retrieve the RoT public UID +USECROTUID

| +USECROTUID | | | | | | |
|-------------------|--|---------------------|-----------------------|-----------------------|----------------------|------------------------|
| Modules | SARA-R410M-63B SARA-R410M-73B SARA-R410M-83B SARA-R422M8S SARA-R422S | | | | | |
| Attributes | Syntax | PIN required | Settings saved | Can be aborted | Response time | Error reference |
| | full | No | No | No | - | +CME Error |

20.2.3.1 Description

Returns the Root of Trust (RoT) public Unique Identifier (UID).



SARA-R422M8S / SARA-R422S

The AT command response time can be up to 150 s due to "security heartbeat" message operation. For more details on when this scenario occurs, see the **+USECCONN** AT command.

20.2.3.2 Syntax

| Type | Syntax | Response | Example |
|--------|---------------|-------------------------------------|---|
| Action | AT+USECROTUID | +USECROTUID: <rot_public_UID> OK | +USECROTUID: "00020000 89285555" OK |

20.2.3.3 Defined values

| Parameter | Type | Description |
|------------------|--------|--------------------------|
| <rot_public_UID> | String | Root of Trust Public UID |

20.2.4 Seal device information +USECDEVINFO

| +USECDEVINFO | | | | | | |
|-------------------|--|---------------------|-----------------------|-----------------------|----------------------|------------------------|
| Modules | SARA-R410M-63B SARA-R410M-73B SARA-R410M-83B SARA-R422M8S SARA-R422S | | | | | |
| Attributes | Syntax | PIN required | Settings saved | Can be aborted | Response time | Error reference |
| | full | No | No | No | < 30 s | +CME Error |

20.2.4.1 Description

Allows the device to seal the device specific information. This command writes the device information, which will be used by the security application to call the corresponding SCL functions. The read command provides a way to check if the security services registration has been completed.

SARA-R422M8S / SARA-R422S

The AT command response time can be up to 150 s due to "security heartbeat" message operation. For more details on when this scenario occurs, see the [+USECCONN](#) AT command.

20.2.4.2 Syntax

| Type | Syntax | Response | Example |
|------|---|---|---|
| Set | AT+USECDEVINFO=<device_info>, <device_serial_num> | OK | AT+USECDEVINFO="ZHIN70 dVgUWCdfNeXHkQRg","SN#4756" OK |
| Read | AT+USECDEVINFO? | +USECDEVINFO: <module_registration>,<device_registration>,<device_activation> OK | +USECDEVINFO: 1,0,1 OK |

20.2.4.3 Defined values

| Parameter | Type | Description |
|-----------------------|--------|--|
| <device_info> | String | Device information structure defined by the SCL library provider; the string is provided by u-blox on request. |
| <device_serial_num> | String | Device serial number. The maximum length is 16 characters. |
| <module_registration> | String | Indicates the status of module registration to security services. Allowed values: <ul style="list-style-type: none"> 0: not registered 1: registered |
| <device_registration> | String | Indicates the status of device registration to security services. Allowed values: <ul style="list-style-type: none"> 0: not registered 1: registered |
| <device_activation> | String | Device's RoT activation status. Allowed values: <ul style="list-style-type: none"> 0: disabled 1: enabled |

20.2.5 Configure secure data suite features +USECMODE

| +USECMODE | | | | | | |
|------------|--|--------------|----------------|----------------|---------------|-----------------|
| Modules | SARA-R410M-63B SARA-R410M-73B SARA-R410M-83B SARA-R422M8S SARA-R422S | | | | | |
| Attributes | Syntax | PIN required | Settings saved | Can be aborted | Response time | Error reference |
| | full | No | NVM | No | < 30 s | +CME Error |

20.2.5.1 Description

Enables / disables the secure data suite features on the module. It can only be used if the module has not been sealed with the [+USECDEVINFO](#) AT command, otherwise an error result code is returned.



After a successful issuance of the command, reboot the module (e.g. by means of the [+CFUN](#) AT command) in order to apply the new configuration.

SARA-R422M8S / SARA-R422S

The AT command response time can be up to 150 s due to "security heartbeat" message operation. For more details on when this scenario occurs, see the [+USECCONN](#) AT command.

20.2.5.2 Syntax

| Type | Syntax | Response | Example |
|------|-------------------------------|--|-------------------------|
| Set | AT+USECMODE=<enable_security> | OK | AT+USECMODE=1 OK |
| Read | AT+USECMODE? | +USECMODE: <enable_security> OK | +USECMODE: 0 OK |

20.2.5.3 Defined values

| Parameter | Type | Description |
|-------------------|--------|--|
| <enable_security> | Number | Disables or enables the security suite features on the module. Allowed values: <ul style="list-style-type: none"> 0: turn the security suite features off |

| Parameter | Type | Description |
|-----------|------|---|
| | | <ul style="list-style-type: none"> 1 (factory-programmed value): turn the security suite features on |

20.2.5.4 Notes

SARA-R410M-63B / SARA-R410M-73B / SARA-R410M-83B

- The command is not supported by SARA-R410M-63B-00, SARA-R410M-73B-00, SARA-R410M-83B-00.

20.2.6 Disable secure data suite features +USECOFF

| +USECOFF | | | | | | |
|------------|--|--------------|----------------|----------------|---------------|-----------------|
| Modules | SARA-R410M-63B SARA-R410M-73B SARA-R410M-83B | | | | | |
| Attributes | Syntax | PIN required | Settings saved | Can be aborted | Response time | Error reference |
| | full | No | NVM | No | < 30 s | +CME Error |

20.2.6.1 Description

Disables the secure data suite features on the module. It can only be used if the module has not been sealed with the [+USECDEVINFO](#) AT command, otherwise an error result code is returned.

Disabling the security feature by means of the AT+USECOFF=1 command causes the failure of the LwM2M client registration with the LwM2M servers, which require the use the pre-shared key (PSK) generated by the root of trust (for more details see the [+ULWM2MCONFIG](#) AT command).

20.2.6.2 Syntax

| Type | Syntax | Response | Example |
|------|-------------------------------|------------------------------------|--------------------|
| Set | AT+USECOFF=<disable_security> | OK | AT+USECOFF=1 OK |
| Read | AT+USECOFF? | +USECOFF: <disable_security> OK | +USECOFF: 0 OK |

20.2.6.3 Defined values

| Parameter | Type | Description |
|--------------------|--------|--|
| <disable_security> | Number | Disables or re-enables the security suite features on the module. Allowed values: <ul style="list-style-type: none"> 0 (factory-programmed value): turn the security suite features on 1: turn the security suite features off |

20.2.6.4 Notes

SARA-R410M-63B / SARA-R410M-73B / SARA-R410M-83B

- The command is only supported by SARA-R410M-63B-00, SARA-R410M-73B-00, SARA-R410M-83B-00.

20.2.7 Security server trigger +USECCONN

| +USECCONN | | | | | | |
|------------|--|--------------|----------------|----------------|---------------|-----------------|
| Modules | SARA-R410M-63B SARA-R410M-73B SARA-R410M-83B SARA-R422M8S SARA-R422S | | | | | |
| Attributes | Syntax | PIN required | Settings saved | Can be aborted | Response time | Error reference |
| | full | No | No | No | < 10 s | - |

20.2.7.1 Description

Triggers the security server by means of a "security heartbeat". An error result code will be returned if the send attempt fails, or if the server does not acknowledge.



SARA-R410M / SARA-R412M

To prevent flooding the server with "security heartbeats", if the command is issued within 5 minutes of the last sent "security heartbeat", the request will be rejected and an error result code will be returned.



SARA-R422M8S / SARA-R422S

To prevent flooding the server with "security heartbeats", if the command is issued within 30 minutes of the last sent "security heartbeat", the request will be rejected and an error result code will be returned.



SARA-R422M8S / SARA-R422S

- The "security heartbeat" message operation is required to update the status of the security.
- The "security heartbeat" message operation is for security reasons required to be an atomic message operation using a blocking send/receive cycle.
- The blocking send/receive cycle can execute up to 150 s (before timeout and abort) in case of network issues.
- The blocking send/receive cycle can block (up to 150 s) the execution of the command (affected commands listed below) which triggered the "security heartbeat" message operation.
- Before executing the blocking send/receive cycle, the "security heartbeat" message operation verifies if the "security heartbeat" message shall be sent immediately due to security reasons.
- Before executing the blocking send/receive cycle, the "security heartbeat" message operation verifies if the "security heartbeat" message shall be sent immediately due to server configured time period elapsed.
- The "security heartbeat" message operation (with the verification mentioned above) is triggered:
 - o At module boot.
 - o When the module resumes operation after exiting power saving mode.
 - o Periodically using a 3 hours resolution timer.
 - o As a completion of the following AT commands:
 - AT+USECROTUID
 - AT+USECDEVINFO?
 - AT+USECDEVINFO=<device_info>,<device_serial_num>
 - AT+USECMODE=<enable_security>
 - AT+USECCONN
 - AT+USECOPCMD="cfgpdn",<apn_name>[,<pdn_ip_type>]
 - AT+USECOPCMD="rotinfo",<info_id>
 - AT+USECOPCMD="secvers"
 - AT+USECDATAENC=<payload_length>[,<filename>]
 - AT+USECDATADEC=<payload_length>[,<filename>]
 - AT+USECFILEENC=<filename>[,<out_file>]
 - AT+USECFILEDEC=<filename>,<out_file>
 - AT+USECE2EDATAENC=<payload_length>[,<filename>]
 - AT+USECE2EFILEENC=<filename>[,<out_file>]
 - AT+USECE2EDATASIGN=<payload_length>[,<filename>]
 - AT+USECE2EFILESIGN=<filename>[,<out_file>]
 - AT+USECE2EDATADEC=<payload_length>[,<filename>]
 - AT+USECE2EFILEDEC=<filename>[,<out_file>]
 - AT+USECC2C=<op_code>,<param1>[,<param2>]
 - AT+USECPSK=<psk_size>
 - AT+USECDEVCERT?
 - AT+USECAFA=<afa_id>
 - AT+UFTPC=<op_code>[,<param1>[,<param2>[,<param3>]]]
 - AT+UHTTPC=<profile_id>,<http_command>,<path>,<filename>[,<param1>[,<param2>[,<param3>]]]
 - AT+UMQTTC=<op_code>[,<param1>[,<param2>][,<param3>][,<param4>][,<param5>]]
 - AT+UMQTTSNC=<op_code>[,<param1>[,<param2>[,<param3>][,<param4>,<param5>,<param6>]]]
 - AT+USOCO=<socket>,<remote_addr>,<remote_port>[,<async_connect>]
 - AT+UCOAPC=<coap_command>[,<payload>,<identifier>[,<block_number>,<more_block>]]

For more information on the "security heartbeat", see the IoT Security-as-a-Service application note [57].

20.2.7.2 Syntax

| Type | Syntax | Response | Example |
|--------|-------------|----------|---------|
| Action | AT+USECCONN | OK | OK |

20.2.8 Security configuration and action command +USECOPCMD

| +USECOPCMD | | | | | | |
|-------------------|-------------------------|---------------------|-----------------------|-----------------------|----------------------|------------------------|
| Modules | SARA-R422M8S SARA-R422S | | | | | |
| Attributes | Syntax | PIN required | Settings saved | Can be aborted | Response time | Error reference |
| | full | No | NVM | No | < 30 s | +CME Error |

20.2.8.1 Description

Generic security command used to store some configuration values or perform actions.



SARA-R422M8S / SARA-R422S

The AT command response time can be up to 150 s due to "security heartbeat" message operation. For more details on when this scenario occurs, see the +USECCONN AT command.



SARA-R422M8S / SARA-R422S

When the information text response to the AT+USECOPCMD="rotrestore",0 command is +USECOPCMD:"rotrestore",1 the following AT commands, if issued, will return the "+CME ERROR: SEC RoT has been restored and a resync operation is pending" error result code (if +CMEE: 2) until a successful AT+USECOPCMD="rotresync" command is executed:

- AT+USECDEVINFO=<device_info>,<device_serial_num>
- AT+USECCONN
- AT+USECPSK=<psk_size>
- AT+USECDATAENC=<payload_length>[,<filename>]
- AT+USECFILEENC=<filename>[,<out_file>]
- AT+USECDATADEC=<payload_length>[,<filename>]
- AT+USECFILEDEC=<filename>,<out_file>
- AT+USECE2EDATAENC=<payload_length>[,<filename>]
- AT+USECE2EFILEENC=<filename>[,<out_file>]

20.2.8.2 Syntax

| Type | Syntax | Response | Example |
|--|--|---|---|
| Generic syntax | | | |
| Set | AT+USECOPCMD=<op_code>,<param1>,<param2> | OK | |
| Read | AT+USECOPCMD=<op_code> | +USECOPCMD: <op_code>,<param1>,<param2> OK | |
| Configure PDN | | | |
| Set | AT+USECOPCMD="cfgpdn",<apn_name>[,<pdn_ip_type>] | OK | AT+USECOPCMD="cfgpdn","internet",0 OK |
| Retrieve secure element information | | | |
| Read | AT+USECOPCMD="rotinfo",<info_id> | +USECOPCMD: "rotinfo",<info_id>,<info_string> OK | AT+USECOPCMD="rotinfo",0 +USECOPCMD: "rotinfo",0,"30312E30362E3832" OK |
| Retrieve secure library version and build version in hexadecimal format | | | |
| Read | AT+USECOPCMD="secvers" | +USECOPCMD: "secvers",<sec_version>,<build_version> OK | AT+USECOPCMD="secvers" +USECOPCMD: "secvers","312E382E33","492D434E57414A2D4245424149" OK |
| Configure E2E (end-to-end) encryption version | | | |
| Set | AT+USECOPCMD="e2e_enc",<version> | OK | AT+USECOPCMD="e2e_enc",0 OK |
| Retrieve E2E (end-to-end) encryption version | | | |
| Read | AT+USECOPCMD="e2e_enc" | +USECOPCMD: "e2e_enc",<version> | AT+USECOPCMD="e2e_enc" |

| Type | Syntax | Response | Example |
|---|---|--|---|
| | | OK | +USECOPCMD: "e2e_enc",1 OK |
| Backup and restore of the RoT persistent data generic syntax | | | |
| Set | AT+USECOPCMD="rotrestore", <restore_cmd> | [+USECOPCMD: "rotrestore", <restore_pending>] OK | AT+USECOPCMD="rotrestore",0 +USECOPCMD: "rotrestore",1 OK |
| Check if the restore of RoT persistent data and configuration from backup is pending | | | |
| Set | AT+USECOPCMD="rotrestore",0 | +USECOPCMD: "rotrestore", <restore_pending> OK | AT+USECOPCMD="rotrestore",0 +USECOPCMD: "rotrestore",1 OK |
| Restore the RoT persistent data and configuration from backup | | | |
| Set | AT+USECOPCMD="rotrestore",1 | OK | AT+USECOPCMD="rotrestore",1 OK |
| Backup the RoT persistent data and configuration | | | |
| Set | AT+USECOPCMD="rotbackup" | OK | AT+USECOPCMD="rotbackup" OK |
| Re-synchronize the RoT persistent data and configuration with the security server | | | |
| Set | AT+USECOPCMD="rotresync" | OK | AT+USECOPCMD="rotresync" OK |

20.2.8.3 Defined values

| Parameter | Type | Description |
|-------------------|--------|---|
| <op_code> | String | Type of operation: <ul style="list-style-type: none"> "cfgpdn": configure the APN used for the connection "rotinfo": retrieve secure element information such as locked FW version, FW version, RoT public UID, platform version, HW info and diagnostic data "secvers": retrieve secure library version and build version in hexadecimal format "e2e_enc": configure end-to-end (E2E) encryption version "rotrestore": restore the RoT persistent data and configuration from backup "rotbackup": backup the RoT persistent data and configuration "rotresync": re-synchronize the RoT persistent data and configuration with security server |
| <apn_name> | String | Network identifier. The maximum size is 100 bytes. The factory-programmed value is an empty string. |
| <pdn_ip_type> | Number | PDN IP type: <ul style="list-style-type: none"> 0: (factory-programmed and default value): IPv4 1: IPv6 2: IPv4 and IPv6 |
| <info_id> | Number | Identifier corresponding to the required information: <ul style="list-style-type: none"> 0: version of the locked firmware 1: version of the application firmware 2: public UID of the RoT (8 bytes string) 3: platform version 4: hardware-specific data 5: diagnostic data |
| <info_string> | String | Requested information according to <info_id> |
| <sec_version> | String | Secure library version in hexadecimal format |
| <build_version> | String | Secure build version in hexadecimal format |
| <version> | Number | E2E encryption version. Allowed values: <ul style="list-style-type: none"> 0: E2E encryption V1 1 (factory-programmed value): E2E encryption V2 |
| <restore_cmd> | Number | RoT restore persistent data and configuration command. Allowed values: <ul style="list-style-type: none"> 0: check if a restore of RoT persistent data and configuration occurred 1: restore the RoT persistent data and configuration from backup |
| <restore_pending> | Number | RoT restore persistent data and configuration pending status. Allowed values: |

| Parameter | Type | Description |
|-----------|------|--|
| | | <ul style="list-style-type: none"> 0: the restore of RoT persistent data and configuration is not pending 1: the restore of RoT persistent data and configuration is pending. A RoT re-synchronization is required (see the AT+USECOPCMD="rotresync"). |

20.2.8.4 Notes

SARA-R422M8S / SARA-R422S

- `<op_code>="e2e_enc"` is not supported.
- `<info_id>=0, 3, 4, 5` are not supported.
- When an `<apn_name>`, which is not present in the list reported by the `+CGDCONT` read command, is used with `AT+USECOPCMD="cfgpdn",<apn_name>[,<pdn_ip_type>]` the `<apn_name>` will be configured for the `<cid>=1` if `<cid>=1` is not active

20.3 Data security

20.3.1 Introduction

20.3.1.1 SSL/TLS/DTLS

SSL/TLS/DTLS (where supported) provides a secure connection between two entities using TCP/UDP socket for communication (i.e. HTTP/FTP server and HTTP/FTP client).

The SSL/TLS/DTLS with digital certificates support provides different connection security aspects:

- **Server authentication:** use of the server certificate verification against a specific trusted certificate or a trusted certificates list;
- **Client authentication:** use of the client certificate and the corresponding private key;
- **Data security and integrity:** data encryption and Hash Message Authentication Code (HMAC) generation.

The security aspects used in the current connection depend on the SSL/TLS/DTLS configuration and features supported by the communicating entities.

u-blox cellular modules support all the described aspects of SSL/TLS/DTLS security protocol with these AT commands:

- [AT+USECMNG](#): import, removal, list and information retrieval of certificates or private keys;
- [AT+USECPRF](#): configuration of USECMNG (u-blox SECurity MaNaGement) profiles used for an SSL/TLS/DTLS connection.

The USECMNG provides a default SSL/TLS/DTLS profile which cannot be modified. The default USECMNG profile provides the following SSL/TLS/DTLS settings:

| Setting | Value | Meaning |
|--|-----------|---|
| Certificates validation level | Level 0 | The server certificate will not be checked or verified. |
| Minimum SSL/TLS/DTLS version | Any | The server can use any of the TLS1.0/TLS1.1/TLS1.2/DTLS1.2 versions for the connection. |
| Cipher suite | Automatic | The cipher suite will be negotiated in the handshake process. |
| Trusted root certificate internal name | "" (none) | No certificate will be used for the server authentication. |
| Expected server host-name | "" (none) | No server host-name is expected. |
| Client certificate internal name | "" (none) | No client certificate will be used. |
| Client private key internal name | "" (none) | No client private key will be used. |
| Client private key password | "" (none) | No client private key password will be used. |
| Pre-shared key | "" (none) | No pre-shared key key password will be used. |
| Server certificate pinning | "" (none) | No server certificate will be used. |
| Server certificate pinning level | Level 0 | No server certificate will be used. |



For the configuration of the settings listed above, see the [+USECPRF](#) AT command.



SARA-R410M / SARA-R412M / SARA-N4

The secure client initiated and server initiated re-negotiation are not supported. When mandated by the server (server initiated re-negotiation) the SSL/TLS/DTLS connection will fail with a generic SSL/TLS/DTLS handshake alert.

The default USECMNG profile does not provide the client certificate internal name and the client private key internal name.



SARA-R422M8S / SARA-R422S

The secure client initiated re-negotiation is not supported. The secure server re-negotiation is supported. The default USECMNG profile does not provide the client certificate internal name and the client private key internal name; hence, when a mutual authentication is required by the server initiated re-negotiation, the client certificate internal name and the client private key internal name need to be provided.



SARA-R422M8S / SARA-R422S

During the handshake a not-activity timer is started at every received or transmitted packet. The timeout of the not-activity timer is set to 30 s. At the timer expiration the secure connection is aborted, since the handshake has not been completed successfully.

20.3.1.2 SARA-R410M-63B / SARA-R410M-73B / SARA-R410M-83B Local encryption and decryption

The **+USECDATAENC**, **+USECDATADEC**, **+USECFILEENC**, **+USECFILEDEC** AT commands provide a method for managing symmetric crypto functions via AT command and to allow device to locally encrypt/decrypt and authenticate critical data (e.g. certificates, tokens) on the device itself.

20.3.1.3 SARA-R410M-63B / SARA-R410M-73B / SARA-R410M-83B Pre-Shared Keys (PSK) provisioning

The **+USECPSK** AT command allows to provision and manage a session unique PSK in the module and in the cloud for application layer security. The PSK is generated and protected by the RoT.

20.3.1.4 SARA-R410M-63B / SARA-R410M-73B / SARA-R410M-83B End-to-end data encryption

The **+USECE2DATAENC**, **+USECE2FILEENC** AT commands allow encrypting data on a device and decrypting asynchronously in the cloud independent of protocols (legacy, etc.), servers, platforms or time before reaching the final destination.

20.3.2 SSL/TLS certificates and private keys manager +USECMNG

| +USECMNG | | | | | | |
|-------------------|--|---------------------|-----------------------|-----------------------|----------------------|----------------------------|
| Modules | SARA-R410M SARA-R412M SARA-R422M8S SARA-R422S SARA-N4 | | | | | |
| Attributes | Syntax | PIN required | Settings saved | Can be aborted | Response time | Error reference |
| | full | No | No | No | - | +CME Error |

20.3.2.1 Description

Manages the X.509 certificates and private keys with the following functionalities:

- Import of certificates and private keys
- List and information retrieval of imported certificates and private keys
- Removal of certificates and private keys
- MD5 calculation of imported certificate or private key

For more details on X.509 certificates and private keys see RFC 5280 [181].

The number and the format of the certificates and the private keys accepted depend on the module series:

- SARA-R410M-02B / SARA-R410M-52B / SARA-R410M-63B / SARA-R410M-73B / SARA-R410M-83B / SARA-R412M / SARA-R422M8S / SARA-R422S / SARA-N4 - certificates and private keys both in DER (Distinguished Encoding Rules) and in PEM (Privacy-Enhanced Mail) format are accepted. If the provided format is PEM, the imported certificate or private key will be automatically converted in DER format for the internal storage. It is also possible to validate certificates and private keys. Up to 16 certificates or private keys can be imported.
- SARA-R410M-01B - only certificates and private keys in DER (Distinguished Encoding Rules) format are accepted. If the provided format is PEM, the imported certificate or private key will be invalid. Up to 16 certificates or private keys can be imported.



The certificates and private keys are kept in DER format and are not retrievable (i.e. cannot be downloaded from the module); for data validation purposes an MD5 hash string of the stored certificate or private key (stored in DER format) can be retrieved.



SARA-R4 / SARA-N4

The SSL/(D)TLS connection can be successfully performed only if keys with at least 512-bit size and/or certificates generated with at least 512-bit key size are used.



SARA-R422M8S / SARA-R422S

The SSL/(D)TLS connection with Server and/or Mutual Authentication can be successfully performed using the following key size:

- for Rivest-Shamir-Adleman (RSA) keys at least 2048-bits.
- for Elliptic Curve Digital Signature Algorithm (ECDSA) keys at least 192-bits.

The same limitation is applied also to the keys used for the certificates generation.



Data for certificate or private key import can be provided with a stream of byte similar to [+UDWNFILE](#) or from a file stored on the FS.



When using the stream of byte import functionality:

- If the data transfer is stopped before its completion, a guard timer of 20 s will ensure the termination of the data transmission. In this case the prompt will switch back in AT command mode and an error result code will be returned.
- If the module shuts down during the data transfer, all the bytes are discarded.
- If any error occurs during the data transfer, all bytes are discarded.



SARA-R4 / SARA-N4

Enable the RTS/CTS DTE flow control (see [&K](#) command description) before to import a stream of bytes.



All the imported certificates or private keys are listed if the type of the security data is omitted.



SARA-R4 / SARA-N4

The imported certificates and private keys are:

- NOT PERSISTED after the module FW is upgraded using EasyFlash.



The USECMNG import command supports only X.509 certificate format.



The X.509 certificate DN (Distinguished Name) is composed of value fields which uniquely define an entity being authenticated. For security reasons some limitations (related to DN fields) described below are applied:

- The USECMNG import functionality allows the following DN value fields:
 - o commonName (<http://oid-info.com/get/2.5.4.3>)
 - o serialNumber (<http://oid-info.com/get/2.5.4.5>)
 - o countryName (<http://oid-info.com/get/2.5.4.6>)
 - o localityName (<http://oid-info.com/get/2.5.4.7>)
 - o stateOrProvinceName (<http://oid-info.com/get/2.5.4.8>)
 - o organizationName (<http://oid-info.com/get/2.5.4.10>)
 - o organizationalUnitName (<http://oid-info.com/get/2.5.4.11>)
 - o userID (<http://oid-info.com/get/0.9.2342.19200300.100.1.1>)
 - o domainComponent (<http://oid-info.com/get/0.9.2342.19200300.100.1.25>)
 - o pkcs9_emailAddress (<http://oid-info.com/get/1.2.840.113549.1.9.1>)
 - o pkcs9_unstructuredName (<http://oid-info.com/get/1.2.840.113549.1.9.2>)
- The import of an X.509 certificate with DN containing other value fields (not in the above list) will result in an import error (error result code: USECMNG invalid certificate/key format).

20.3.2.2 Syntax

| Type | Syntax | Response | Example |
|---|---|----------------------------|--|
| Generic syntax: | | | |
| Action | AT+USECMNG=<op_code>, [<type>[,<internal_name>[, <param1>[,<param2>]]]] | OK | - |
| Import a certificate or private key from serial I/O: | | | |
| Action | AT+USECMNG=0,<type>,<internal_> name>,<data_size>[,<password>] | Start transfer of data ... | AT+USECMNG=0,0,"AddTrustCA", 1327 >-----BEGIN CERTIFICATE----- |

| Type | Syntax | Response | Example |
|--|---|--|--|
| | | +USECMNG: 0,<type>,<internal_name>,<md5_string> OK | (...other certificate data bytes...) +USECMNG: 0,0,"AddTrustCA", "77107370ec4db40a0 8a6e36a64a1435b" OK |
| Import a certificate or private key from a file stored on FS: | | | |
| Action | AT+USECMNG=1,<type>,<internal_name>,<filename>[,<password>] | +USECMNG: 1,<type>,<internal_name>,<md5_string> OK | AT+USECMNG=1,0,"AddTrustCA", "addtrust.cert" +USECMNG: 1,0,"AddTrustCA", "77107370ec4db40a08a6e36a64a1435b" OK |
| Remove an imported certificate or private key: | | | |
| Action | AT+USECMNG=2,<type>,<internal_name> | OK | AT+USECMNG=2,0,"AddTrustCA" OK |
| List imported certificates or private keys: | | | |
| Read | AT+USECMNG=3[,<type>] | <cert_type>,<internal_name>[,<common_name>,<expiration_date>] ... OK | AT+USECMNG=3 "CA","AddTrustCA","AddTrust External CA Root","2020/05/30" "CA","GlobalSignCA","GlobalSign", "2029/03/18" "CC","JohnDoeCC","GlobalSign","20 10/01/01" "PK","JohnDoePK" OK |
| Retrieve the MD5 of an imported certificate or private key: | | | |
| Read | AT+USECMNG=4,<type>,<internal_name> | +USECMNG: 4,<type>,<internal_name>,<md5_string> OK | AT+USECMNG=4,0,"AddTrustCA" +USECMNG: 4,0,"AddTrustCA", "77107370ec4db40a0 8a6e36a64a1435b" OK |
| Test | AT+USECMNG=? | +USECMNG: (list of supported <op_code>s),(list of supported <type>s) OK | +USECMNG: (0-4),(0-2) OK |

20.3.2.3 Defined values

| Parameter | Type | Description |
|-------------|--------|---|
| <op_code> | Number | Type of operation: <ul style="list-style-type: none"> 0: import a certificate or a private key (data provided by the stream of byte) 1: import a certificate or a private key (data provided from a file on FS) 2: remove an imported certificate or private key 3: list imported certificates or private keys 4: retrieve the MD5 of an imported certificate or private key |
| <type> | Number | Type of the security data: <ul style="list-style-type: none"> 0: trusted root CA (certificate authority) certificate 1: client certificate 2: client private key 3: server certificate 4: signature verification certificate 5: signature verification public key Allowed values: <ul style="list-style-type: none"> SARA-R4 / SARA-N4 - 0, 1, 2 |
| <cert_type> | String | Type of the security data in verbose format: <ul style="list-style-type: none"> "CA": trusted root CA (certificate authority) certificate "CC": client certificate |

| Parameter | Type | Description |
|-------------------|-------------------|--|
| | | <ul style="list-style-type: none"> "PK": client private key "SC": server certificate "VC": signature verification certificate "PU": signature verification public key Allowed values: <ul style="list-style-type: none"> SARA-R4 / SARA-N4 - "CA", "CC", "PK" |
| <internal_name> | String | Unique identifier of an imported certificate or private key. If an existing name is used the data will be overridden. <ul style="list-style-type: none"> SARA-R422M8S / SARA-R422S - The maximum length is 200 characters. SARA-R410M / SARA-R412M / SARA-N4 - The maximum length is 113 characters. |
| <data_size> | Number | Size in bytes of a certificate or private key being imported. <ul style="list-style-type: none"> SARA-R4 / SARA-N4 - The maximum allowed size is 8192 bytes. |
| <password> | String | Decryption password; applicable only for PKCS8 encrypted client private keys. The maximum length is 128 characters. |
| <filename> | String | Name of the FS file containing the certificate or private key data to be imported. <ul style="list-style-type: none"> SARA-R4 / SARA-N4 - The maximum allowed file size is 8192 bytes. |
| <md5_string> | String | MD5 formatted string. |
| <common_name> | String | Certificate subject (issued to) common name; applicable only for trusted root and client certificates. |
| <expiration_date> | String | Certificate expiration (valid to date); applicable only for trusted root and client certificates. |
| <param1> | Number/ String | Type and supported content depend on the related <op_code> parameter; see the <op_code> specification. |
| <param2> | Number/ String | Type and supported content depend on the related <op_code> parameter; see the <op_code> specification. |

20.3.2.4 Notes

SARA-R410M-01B

- The <password>, <common_name> and <expiration_date> parameters are not supported.
- The certificates in the PEM format are not supported; they will not be automatically converted to the DER format.

20.3.3 SSL/TLS/DTLS security layer profile manager +USECPRF

| +USECPRF | | | | | | |
|-------------------|--|---------------------|-----------------------|-----------------------|----------------------|----------------------------|
| Modules | SARA-R410M SARA-R412M SARA-R422M8S SARA-R422S SARA-N4 | | | | | |
| Attributes | Syntax | PIN required | Settings saved | Can be aborted | Response time | Error reference |
| | partial | No | No | No | - | +CME Error |

20.3.3.1 Description

Manages security profiles for the configuration of the following SSL/TLS/DTLS connections properties:

- Certificate validation level:**
 - Level 0: no certificate validation; the server certificate will not be checked or verified. No additional certificates are needed.
 - Level 1: certificate validation against a specific or a list of imported trusted root certificates.
 - Level 2: certificate validation with an additional URL integrity check (the server certificate common name must match the server hostname).
 - Level 3: certificate validation with an additional check on the certificate validity date. CA certificates should be imported with the [+USECMNG](#) AT command
- Minimum SSL/TLS version to be used:**
 - Any
 - TLS 1.0
 - TLS 1.1
 - TLS 1.2
- Minimum DTLS version to be used:**
 - DTLS 1.2

- **Cipher suite to be configured using the following methods:**
 - **Legacy cipher suite** to be used. See [Syntax description](#) and [Table 30](#) for the supported cipher suites.
 - **Additional cipher suite** to be used with Internet Assigned Numbers Authority (IANA) enumeration set command. See [Syntax description](#) and [Table 30](#) for the supported cipher suites.
 - **List of cipher suites** to be used is configured with add / remove commands and using IANA enumeration. See [Syntax description](#) and [Table 30](#) for the supported cipher suites.

For the applicability of cipher suite depending on the module series, see [Cipher suites applicability](#).

Cipher suite configuration methods are exclusive and the last configured method is used.

The cipher suite configuration read command response is related to the selected cipher suite type, see [Syntax description](#) for more details.

- **Certificate to be used for server and mutual authentication:**
 - The trusted root certificate. The CA certificate should be imported with the **+USECMNG** AT command.
 - The client certificate that should be imported with the **+USECMNG** AT command.
 - The client private key that should be imported with the **+USECMNG** AT command.
 - The server certificate that should be imported with the **+USECMNG** AT command.

- **Expected server hostname, when using certificate validation level 2 or 3.**

- **Password for the client private key, if it is password protected.**

- **Pre-shared key used for connection. Defines a pre-shared key and key-name (PSK), when a TLS_PSK_* cipher suite is used.**

- **SNI (Server Name Indication).** SNI is a feature of SSL/TLS which uses an additional SSL/TLS extension header to specify the server name to which the client is connecting to. The extension was introduced to support the certificate handling used with virtual hosting provided by the various SSL/TLS enabled servers mostly in cloud based infrastructures. With the SNI a server has the opportunity to present a different server certificate (or/and whole SSL/TLS configuration) based on the host indicated by the SNI extension. When SNI is not used the modules might receive a non host specific SSL/TLS configuration (version/cipher suites/certificate) when used with virtual hosts.

- **(D)TLS session resumption.** The session resumption feature allows to reuse the secure session data in order to reestablish a SSL/(D)TLS secure session. Since the secure session data are available, the SSL/(D)TLS handshake is not performed during the session resumption. Once the session resumption feature is enabled, the session resumption type (provided by the server) and the secure session data (negotiated during the SSL/(D)TLS handshake) are displayed via **+USECPRF** URC message. The session resumption feature configuration and secure session data are not stored in the NVM, hence the session resumption may be performed until power cycle.

To set all the parameters in security profile, a set command for each `<op_code>` needs to be issued (e.g. certificate validation level, minimum SSL/TLS/DTLS version, ...).

To reset (set to factory-programmed value) all the parameters of a specific security profile, issue the AT **+USECPRF=<profile_id>** command.

20.3.3.2 Syntax



| Type | Syntax | Response | Example |
|--------------------------------------|--|--|---|
| Generic syntax | | | |
| Set | AT+USECPRF=<profile_id>[,<op_code>[,<param_val1>[,<param_val2>[,<param_val3>]]]] | OK | AT+USECPRF=0,0,0 OK |
| Read | AT+USECPRF=<profile_id>,<op_code> | +USECPRF: <profile_id>,<op_code>,<param_val1> OK | AT+USECPRF=0,0 +USECPRF: 0,0,0 OK |
| URC | | +UUSECPRF: <profile_id>,<op_code>[,<param_val1>[,<param_val2>[,<param_val3>]]] OK | +UUSECPRF: 0,13,1,0 OK |
| Legacy cipher suite selection | | | |
| Set | AT+USECPRF=<profile_id>,2,<legacy_cs> | OK | AT+USECPRF=0,2,2 OK |

| Type | Syntax | Response | Example |
|---|---|--|---|
| Cipher suite selection using IANA enumeration | | | |
| Set | AT+USECPRF=<profile_id>,2,99,<iana_b1>,<iana_b2> | OK | AT+USECPRF=0,2,99,"C0","2B" OK |
| Read | AT+USECPRF=<profile_id>,2 | +USECPRF: <profile_id>,2,99,<iana_b1>,<iana_b2> OK | AT+USECPRF=0,2 +USECPRF: 0,2,99,"C0","2B" OK |
| Add/remove of IANA cipher suite to the configured cipher suites list | | | |
| Set | AT+USECPRF=<profile_id>,2,100,<iana_b1>,<iana_b2>,<operation> | OK | AT+USECPRF=0,2,100,"C0","2A",0 OK |
| Add an IANA cipher suite to the configured cipher suites list | | | |
| Set | AT+USECPRF=<profile_id>,2,100,<iana_b1>,<iana_b2>,0 | OK | AT+USECPRF=0,2,100,"C0","2A",0 OK |
| Remove an IANA cipher suite from the configured cipher suites list | | | |
| Set | AT+USECPRF=<profile_id>,2,100,<iana_b1>,<iana_b2>,1 | OK | AT+USECPRF=0,2,100,"C0","2B",1 OK |
| Read the list of configured cipher suites | | | |
| Read | AT+USECPRF=<profile_id>,2 | +USECPRF: <profile_id>,2,100,<list of configured cipher suites separated by ";"> OK | AT+USECPRF=0,2 +USECPRF: 0,2,100,"C02A;C02C" OK |
| Pre-shared key configuration | | | |
| Set | AT+USECPRF=<profile_id>,8,<preshaed_key>[,<string_type>] | OK | AT+USECPRF=0,8,"0sFpZ0AZqE0N6Ti9s0qt40ZP5Eqx" OK |
| Pre-shared key identity configuration | | | |
| Set | AT+USECPRF=<profile_id>,9,<preshaed_key_id>[,<string_type>] | OK | AT+USECPRF=0,9,"0ceEZ0AZqP0K60i9o04xz0ZP8zyu0Eqx" OK |
| Server certificate pinning | | | |
| Set | AT+USECPRF=<profile_id>,12,<server_certificate>,<pinning_level> | OK | AT+USECPRF=0,12,"my_srv_cert",0 OK |
| (D)TLS session resumption generic syntax | | | |
| Set | AT+USECPRF=<profile_id>,13,<tag>,<param_val1>[,<param_val2>] | OK | AT+USECPRF=0,13,0,1 OK |
| Read | AT+USECPRF=<profile_id>,13,<tag> | +USECPRF: <profile_id>,13,<tag>,<param_val1>[,<param_val2>] OK | AT+USECPRF=0,13,0 +USECPRF: 0,13,0,1 OK |
| URC | | +UUSECPRF: <profile_id>,13,<tag>,<param_val1>[,<param_val2>] OK | +UUSECPRF: 0,13,1,0 OK |
| (D)TLS session resumption status | | | |
| Set | AT+USECPRF=<profile_id>,13,0,<sess_status> | OK | AT+USECPRF=0,13,0,1 OK |
| Read | AT+USECPRF=<profile_id>,13,0 | +USECPRF: <profile_id>,13,0,<sess_status> OK | AT+USECPRF=0,13,0 +USECPRF: 0,13,0,1 OK |
| (D)TLS session resumption session type | | | |
| Set | AT+USECPRF=<profile_id>,13,1,<sess_type> | OK | AT+USECPRF=0,13,1,0 OK |
| Read | AT+USECPRF=<profile_id>,13,1 | +USECPRF: <profile_id>,13,1,<sess_type> OK | AT+USECPRF=0,13,1 +USECPRF: 0,13,1,0 |

| Type | Syntax | Response | Example |
|--|---|--|---|
| | | OK | OK |
| URC | | +UUSECPRF: <profile_id>,13,1, <sess_type> | +UUSECPRF: 0,13,1,0 |
| (D)TLS session resumption session data having session ID as session resumption type | | | |
| Set | AT+UUSECPRF=<profile_id>,13,2, <session_id_base64>,<master_secret_base64> | OK | AT+UUSECPRF=0,13,2,"VWY5UENs0Hh3VWR1MjB2WTVMYVZ5TTdEO WpMeWZWeHo=","SHVSODByUit0 My9OMEtIT2ZsVVFRCUsyTkdvaz0 nWVFhRzdQZUpndG9IMzN4ZTBo" OK |
| Read | AT+UUSECPRF=<profile_id>,13,2 | +USECPRF: <profile_id>,13,2, <session_id_base64>,<master_secret_base64> OK | AT+UUSECPRF=0,13,2 +USECPRF: 0,13,2,"VWY5UENs0Hh3VWR1MjB2WTVMYVZ5TTdEO WpMeWZWeHo=","SHVSODByUit0 My9OMEtIT2ZsVVFRCUsyTkdvaz0 nWVFhRzdQZUpndG9IMzN4ZTBo" OK |
| URC | | +UUSECPRF: <profile_id>,13,2, <session_id_base64>,<master_secret_base64> | +UUSECPRF: 0,13,2,"VWY5UENs0Hh3VWR1MjB2WTVMYVZ5TTdEO WpMeWZWeHo=","SHVSODByUit0 My9OMEtIT2ZsVVFRCUsyTkdvaz0 nWVFhRzdQZUpndG9IMzN4ZTBo" |
| (D)TLS session resumption session data having encrypted session ID with local encryption as session resumption type | | | |
| Set | AT+UUSECPRF=<profile_id>,13,12, <encrypted_session_data>,<enc_session_data_size> | OK | AT+UUSECPRF=0,13,12, "AAECAwQFBgclCQoLDA0 ODxAREhMUFYXGBkaGxwdHh/ Ljgstf1cLaEO2D8IMbxHcQIGfhVxCO in6aGVISJGBWCAAKJo6Qw5Q +ugXaRZFquGO O69WeHnPRBkcwY2SN4bwnDbyR +709iOpt2nlaYMSCL77MAA=","156 OK |
| Read | AT+UUSECPRF=<profile_id>,13,12 | +USECPRF: <profile_id>,13,12, <encrypted_session_data>,(0-203) OK | AT+UUSECPRF=0,13,12 +USECPRF: 0,13,12, "AAECAwQFBgclCQoLDA0 ODxAREhMUFYXGBkaGxwdHh/ Ljgstf1cLaEO2D8IMbxHcQIGfhVxCO in6aGVISJGBWCAAKJo6Qw5Q +ugXaRZFquGO O69WeHnPRBkcwY2SN4bwnDbyR +709iOpt2nlaYMSCL77MAA=","156 OK |
| URC | | +UUSECPRF: <profile_id>,13,12, <encrypted_session_data>,(0-203) | +UUSECPRF: 0,13,12, "AAECAwQFBgclCQoLDA0 ODxAREhMUFYXGBkaGxwdHh/ Ljgstf1cLaEO2D8IMbxHcQIGfhVxCO in6aGVISJGBWCAAKJo6Qw5Q +ugXaRZFquGO O69WeHnPRBkcwY2SN4bwnDbyR +709iOpt2nlaYMSCL77MAA=","156 |
| Test | AT+UUSECPRF=? | +USECPRF: (list of supported <profile_id>s),(list of supported <op_code>s) OK | +USECPRF: (0-4),(0-13) OK |

20.3.3.3 Defined values

| Parameter | Type | Description |
|--------------|--------|--|
| <profile_id> | Number | USECMNG security profile identifier, in range 0-4; if it is not followed by other parameters the profile settings will be reset (set to factory-programmed value). |
| <op_code> | Number | • 0: certificate validation level; allowed values for <param_val1> (number): |

| Parameter | Type | Description |
|-----------|------|--|
| | | <ul style="list-style-type: none"> o 0: level 0 - No validation; the server certificate will not be checked or verified. The server in this case is not authenticated. o 1: level 1 - Root certificate validation without URL integrity check. The server certificate will be verified with a specific trusted certificates or with each of the imported trusted root certificates. o 2: level 2 - Root certificate validation with URL integrity check. Level 1 validation with an additional URL integrity check. o 3: level 3 - Root certificate validation with check of certificate validity date. Level 2 validation with an additional check of certificate validity date. |
| | | <ul style="list-style-type: none"> • 1: SSL/TLS version to use; allowed values for <param_val1>(number): <ul style="list-style-type: none"> o 0 (factory-programmed value): any; server can use any version for the connection. o 1: TLS v1.0; connection allowed only to TLS/SSL servers which support TLS v1.0 o 2: TLS v1.1; connection allowed only to TLS/SSL servers which support TLS v1.1 o 3: TLS v1.2; connection allowed only to TLS/SSL servers which support TLS v1.2 |
| | | <ul style="list-style-type: none"> • 2: cipher suite; allowed values for <legacy_cs> (number) legacy cipher suites are listed in Table 30. The factory-programmed value for <legacy_cs> is 0. For <legacy_cs>=0 a list of default cipher suites is proposed at the beginning of handshake process, and a cipher suite will be negotiated among the cipher suites proposed in the list. For <legacy_cs>=99 the cipher suite selection is performed with IANA enumeration, <iانا_b1> and <iانا_b2> are strings containing the 2 bytes that compose the IANA enumeration, see Table 30. For <legacy_cs>=100 the list of cipher suites is configured using IANA enumeration, <iانا_b1> and <iانا_b2> are strings containing the 2 bytes that compose the IANA enumeration, see Table 30. <p> The cipher suite configuration read command response is related to the selected cipher suite type. In the case of <legacy_cs>=99 the configured <byte_1> and <byte_2> are reported in the information text response to the read command. In the case of <legacy_cs>=100 a ";" separated list with configured cipher suites is reported in the information text response to the read command.</p> <p> For <legacy_cs>=100, when all added cipher suites are removed the cipher suite is automatically set to 0 (factory-programmed value).</p> <p> For the applicability of default cipher suite lists depending on the module series, see Cipher suites applicability.</p> |
| | | <ul style="list-style-type: none"> • 3: trusted root certificate internal name; <ul style="list-style-type: none"> o <param_val1> (string) is the internal name identifying a trusted root certificate; the maximum length is 200 characters. The factory-programmed value is an empty string. • 4: expected server hostname; <ul style="list-style-type: none"> o <param_val1> (string) is the hostname of the server, used when certificate validation level is set to Level 2; the maximum length is 256 characters. The factory-programmed value is an empty string. • 5: client certificate internal name; <ul style="list-style-type: none"> o <param_val1> (string) is the internal name identifying a client certificate to be sent to the server; the maximum length is 200 characters. The factory-programmed value is an empty string. • 6: client private key internal name; <ul style="list-style-type: none"> o <param_val1> (string) is the internal name identifying a private key to be used; the maximum length is 200 characters. The factory-programmed value is an empty string. • 7: client private key password; <ul style="list-style-type: none"> o <param_val1> (string) is the password for the client private key if it is password protected; the maximum length is 128 characters. The factory-programmed value is an empty string. • 8: pre-shared key; <ul style="list-style-type: none"> o <preshared_key> (string) is the pre-shared key used for connection; the factory-programmed value is an empty string. The accepted string type and length depends on the <string_type> value. o <string_type> (number) defines the type and the maximum length of the <preshared_key> string. Allowed values for <string_type>: <ul style="list-style-type: none"> - 0 (default value): <preshared_key> is an ASCII string and its maximum length is 64 characters - 1: <preshared_key> is a hexadecimal string and its maximum length is 128 characters • 9: pre-shared key identity; <ul style="list-style-type: none"> o <preshared_key_id> (string) is the pre-shared key identity used for connection; the factory-programmed value is an empty string. The accepted string type and length depends on the <string_type> value. |

| Parameter | Type | Description |
|--------------------------|--------|--|
| | | <ul style="list-style-type: none"> o <string_type> (number) defines the type of the <presared_key_id> string. Allowed values for <string_type>: <ul style="list-style-type: none"> - 0 (default value): <presared_key_id> is an ASCII string and its maximum length is 128 characters - 1: <presared_key_id> is an hexadecimal string and its maximum length is 256 characters • 10: SNI (Server Name Indication); <ul style="list-style-type: none"> o <param_val1> (string) value for the additional negotiation header SNI (Server Name Indication) used in SSL/TLS connection negotiation; the maximum length is 128 characters. The factory-programmed value is an empty string. • 11: PSK key and PSK key identity generated by RoT (Root of trust); allowed values for <param_val1> (number): <ul style="list-style-type: none"> o 0 (factory-programmed value): OFF - The PSK and PSK key ID are NOT generated by RoT o 1: ON - The PSK and PSK key ID are generated by RoT in the process of SSL/TLS connection negotiation • 12: server certificate pinning; <ul style="list-style-type: none"> o <server_certificate> (string) internal name identifying a certificate configured to be used for server certificate pinning; the maximum length is 200 characters. The factory-programmed value is an empty string. o <pinning_level> (number) defines the certificate pinning information level. Allowed values for <pinning_level> <ul style="list-style-type: none"> - 0: pinning based on information comparison of received and configured certificate public key - 1: pinning based on binary comparison of received and configured certificate public key - 2: pinning based on binary comparison of received and configured certificate • 13: (D)TLS session resumption <ul style="list-style-type: none"> Allowed values: <ul style="list-style-type: none"> • SARA-R410M-63B / SARA-R410M-73B / SARA-R410M-83B / SARA-R422M8S / SARA-R422S - 0, 1, 2, 3, 4, 5, 6, 7, 8, 9, 10, 11, 13 • SARA-R410M-02B / SARA-R412M - 0, 1, 2, 3, 4, 5, 6, 7, 8, 9, 10 • SARA-R410M-01B / SARA-R410M-52B / SARA-N4 - 0, 1, 2, 3, 4, 5, 6, 7, 8, 9 |
| <legacy_cs> | Number | Legacy cipher suite enumeration |
| <iana_b1> | String | First byte of IANA cipher suite enumeration |
| <iana_b2> | String | Second byte of IANA cipher suite enumeration |
| <operation> | Number | Operation to execute when using <legacy_cs>=100 configuration using a list of IANA enumeration. Allowed values for <operation>: <ul style="list-style-type: none"> • 0: add cipher suite defined by <iana_b1> and <iana_b2> to the list • 1: remove cipher suite defined by <iana_b1> and <iana_b2> from the list |
| <tag> | Number | Configures the (D)TLS session resumption. Allowed values: <ul style="list-style-type: none"> • 0: session resumption status • 1: session resumption type • 2: session resumption data when the session resumption type is session ID • 12: session resumption data for when the session resumption type is encrypted session ID with local encryption |
| <sess_status> | Number | (D)TLS session resumption status. Allowed values: <ul style="list-style-type: none"> • 0 (factory-programmed value): disabled • 1: enabled |
| <sess_type> | Number | (D)TLS session resumption type. Allowed values: <ul style="list-style-type: none"> • 0: session ID • 10: encrypted session ID with local encryption |
| <session_id_base64> | String | base64 encoded session ID value. The maximum length is 48 characters. |
| <master_secret_base64> | String | base64 encoded session master key. The maximum length is 64 characters. |
| <encrypted_session_data> | String | base64 encoded session ID value encrypted with local encryption. The maximum length is 203 characters |
| <enc_session_data_size> | Number | length of base64 encoded session ID value encrypted with local encryption. |
| <param_val1> | String | Type and supported content depend on related <op_code> (details are given above) |

| Parameter | Type | Description |
|--------------|--------|--|
| <param_val2> | String | Type and supported content depend on related <op_code> (details are given above) |
| <param_val3> | String | Type and supported content depend on related <op_code> (details are given above) |

20.3.3.4 Notes

SARA-R422M8S / SARA-R422S

- If <op_code>=2 (cipher suite) the <legacy_cs>=100 (cipher suite list configuration using IANA enumeration) is not supported.
- If <op_code>=9 (pre-shared key identity) the <string_type> parameter is not supported. The <preshared_key_id> parameter is an ASCII string (maximum length 128 characters).
- If <op_code>=13 ((D)TLS session resumption) and <tag>=1 (session resumption type), only <param_val1>=0 (session ID) and <param_val1>=10 (encrypted session ID with local encryption) are supported.
- The unique minimum SSL/TLS version (<op_code>=1) is not supported when used with UDP connection. With UDP connection only the DTLS version 1.2 is supported and is automatically configured.
- The factory-programmed value for <op_code>=0 (certificate validation level) is 1 (level 1 - Root certificate validation without URL integrity check. The server certificate will be verified with a specific trusted certificates or with each of the imported trusted root certificates).
- The factory-programmed value for <op_code>=1 (SSL/TLS version to use) is 3 (TLS v1.2; connection allowed only to TLS/SSL servers which support TLS v1.2).
- If <op_code>=11 (PSK key and PSK key identity generated by RoT) and the corresponding <param_val1>=1 (ON), the DTLS/TLS subsystem will use the SCL/RoT to generate the PSK secret, therefore the security suite features must be enabled (**+USECMODE:1**). The connection time could be up to 150 s due to "security heartbeat" message operation. For more details on when this scenario occurs, see the **+USECCONN** AT command.
- If <op_code>=13 ((D)TLS session resumption), <tag>=1 (session resumption type) and <sess_type>=10 (encrypted session ID with local encryption), the DTLS/TLS subsystem will use the SCL/RoT to encrypt/decrypt the session resumption data, therefore the security suite features must be enabled (**+USECMODE:1**). The connection time could be up to 150 s due to "security heartbeat" message operation. For more details on when this scenario occurs, see the **+USECCONN** AT command.

SARA-R410M / SARA-R412M / SARA-N4

- The factory-programmed value for <op_code>=0 (certificate validation level) is 0 (level 0 - No validation; the server certificate will not be checked or verified. The server in this case is not authenticated).
- The factory-programmed value for <op_code>=1 (SSL/TLS version to use) is 0 (any; server can use any version for the connection).
- If <op_code>=2 (cipher suite) the <legacy_cs>=100 (cipher suite list configuration using IANA enumeration) is not supported.

SARA-R410M-63B / SARA-R410M-73B / SARA-R410M-83B

- If <op_code>=13 ((D)TLS session resumption) and <tag>=1 (session resumption type), only <param_val1>=0 (session ID) is supported.
- The cipher suite TLS_PSK_WITH_3DES_EDE_CBC_SHA (<legacy_cs>=8) corresponds to cipher suite TLS_RSA_PSK_WITH_AES_128_CBC_SHA (<legacy_cs>=9, <iana_b1>="00", <iana_b2>="94").
- The cipher suite TLS_RSA_PSK_WITH_AES_128_CBC_SHA (<legacy_cs>=9) corresponds to cipher suite TLS_PSK_WITH_AES_128_CBC_SHA256 (<legacy_cs>=12, <iana_b1>="00", <iana_b2>="AE").
- The cipher suite TLS_RSA_PSK_WITH_AES_256_CBC_SHA (<legacy_cs>=10) corresponds to cipher suite TLS_PSK_WITH_AES_256_CBC_SHA384 (<legacy_cs>=13, <iana_b1>="00", <iana_b2>="AF").
- The cipher suite TLS_PSK_WITH_AES_128_CBC_SHA256 (<legacy_cs>=12) corresponds to cipher suite TLS_RSA_PSK_WITH_AES_256_CBC_SHA (<legacy_cs>=10, <iana_b1>="00", <iana_b2>="95").
- The cipher suite TLS_PSK_WITH_AES_256_CBC_SHA384 (<legacy_cs>=13) corresponds to cipher suite TLS_PSK_WITH_3DES_EDE_CBC_SHA (<legacy_cs>=8, <iana_b1>="00", <iana_b2>="8B").

SARA-R410M-02B / SARA-R412M

- If <op_code>=2 (cipher suite) the <legacy_cs>=99 (cipher suite selection using IANA enumeration) is not supported by SARA-R410M-02B-00, SARA-R410M-02B-01, SARA-R410M-02B-02, SARA-R412M-02B-00, SARA-R412M-02B-01, SARA-R412M-02B-02.
- If <op_code>=8 (pre-shared key) the <string_type> parameter is not supported. The <preshared_key> parameter is an ASCII string (maximum length 64 characters).

- If <op_code>=9 (pre-shared key identity) the <string_type> parameter is not supported. The <preshared_key_id> parameter is an ASCII string (maximum length 128 characters).
- On SARA-R410M-02B-00, SARA-R410M-02B-01, SARA-R410M-02B-02, and SARA-R412M-02B-00 allowed values are: 0, 1, 2, 3, 4, 5, 6, 7, 8, 9.

SARA-R410M-01B

- If <op_code>=2 (cipher suite) the <legacy_cs>=99 (cipher suite selection using IANA enumeration) is not supported.
- If <op_code>=8 (pre-shared key) the <string_type> parameter is not supported. The <preshared_key> parameter is an ASCII string (maximum length 64 characters).
- If <op_code>=9 (pre-shared key identity) the <string_type> parameter is not supported. The <preshared_key_id> parameter is an ASCII string (maximum length 128 characters).
- The unique certificate validation level (<op_code>=0) supported is the level 0 (no validation, <param_val>=0).
- The unique minimum SSL/TLS version (<op_code>=1) supported is <param_val>=0 (the server can use any version for the connection).

SARA-R410M-52B / SARA-N4

- If <op_code>=2 (cipher suite) the <legacy_cs>=99 (cipher suite selection using IANA enumeration) is not supported.
- If <op_code>=8 (pre-shared key) the <string_type> parameter is not supported. The <preshared_key> parameter is an ASCII string (maximum length 64 characters).
- If <op_code>=9 (pre-shared key identity) the <string_type> parameter is not supported. The <preshared_key_id> parameter is an ASCII string (maximum length 128 characters).

20.3.3.5 List of the supported cipher suites

| Cipher suite IANA code | Cipher suite name | Legacy cipher suite configuration | IANA enumeration cipher suite configuration | |
|------------------------|---------------------------------------|-----------------------------------|---|-----------|
| | | <legacy_cs> | <iana_b1> | <iana_b2> |
| 0x0000 | TLS_NULL_WITH_NULL_NULL | | "00" | "00" |
| 0x000A | TLS_RSA_WITH_3DES_EDE_CBC_SHA | 5 | "00" | "0A" |
| 0x0013 | TLS_DHE_DSS_WITH_3DES_EDE_CBC_SHA | | "00" | "13" |
| 0x0015 | TLS_DHE_RSA_WITH_DES_CBC_SHA | | "00" | "15" |
| 0x0016 | TLS_DHE_RSA_WITH_3DES_EDE_CBC_SHA | | "00" | "16" |
| 0x001A | TLS_DH_anon_WITH_DES_CBC_SHA | | "00" | "1A" |
| 0x001B | TLS_DH_anon_WITH_3DES_EDE_CBC_SHA | | "00" | "1B" |
| 0x002F | TLS_RSA_WITH_AES_128_CBC_SHA | 1 | "00" | "2F" |
| 0x0032 | TLS_DHE_DSS_WITH_AES_128_CBC_SHA | | "00" | "32" |
| 0x0033 | TLS_DHE_RSA_WITH_AES_128_CBC_SHA | | "00" | "33" |
| 0x0034 | TLS_DH_anon_WITH_AES_128_CBC_SHA | | "00" | "34" |
| 0x0035 | TLS_RSA_WITH_AES_256_CBC_SHA | 3 | "00" | "35" |
| 0x0039 | TLS_DHE_RSA_WITH_AES_256_CBC_SHA | | "00" | "39" |
| 0x003A | TLS_DH_anon_WITH_AES_256_CBC_SHA | | "00" | "3A" |
| 0x003C | TLS_RSA_WITH_AES_128_CBC_SHA256 | 2 | "00" | "3C" |
| 0x003D | TLS_RSA_WITH_AES_256_CBC_SHA256 | 4 | "00" | "3D" |
| 0x0040 | TLS_DHE_DSS_WITH_AES_128_CBC_SHA256 | | "00" | "40" |
| 0x0041 | TLS_RSA_WITH_CAMELLIA_128_CBC_SHA | | "00" | "41" |
| 0x0045 | TLS_DHE_RSA_WITH_CAMELLIA_128_CBC_SHA | | "00" | "45" |
| 0x0067 | TLS_DHE_RSA_WITH_AES_128_CBC_SHA256 | | "00" | "67" |
| 0x006B | TLS_DHE_RSA_WITH_AES_256_CBC_SHA256 | | "00" | "6B" |
| 0x006C | TLS_DH_anon_WITH_AES_128_CBC_SHA256 | | "00" | "6C" |
| 0x006D | TLS_DH_anon_WITH_AES_256_CBC_SHA256 | | "00" | "6D" |
| 0x0084 | TLS_RSA_WITH_CAMELLIA_256_CBC_SHA | | "00" | "84" |
| 0x0088 | TLS_DHE_RSA_WITH_CAMELLIA_256_CBC_SHA | | "00" | "88" |
| 0x008A | TLS_PSK_WITH_RC4_128_SHA | | "00" | "8A" |
| 0x008B | TLS_PSK_WITH_3DES_EDE_CBC_SHA | 8 | "00" | "8B" |
| 0x008C | TLS_PSK_WITH_AES_128_CBC_SHA | 6 | "00" | "8C" |

| Cipher suite IANA code | Cipher suite name | Legacy cipher suite configuration | IANA enumeration cipher suite configuration | |
|---------------------------|--|---|---|---------------------|
| | | | <legacy_cs> | <iana_b1> <iana_b2> |
| 0x008D | TLS_PSK_WITH_AES_256_CBC_SHA | 7 | "00" | "8D" |
| 0x008E | TLS_DHE_PSK_WITH_RC4_128_SHA | | "00" | "8E" |
| 0x008F | TLS_DHE_PSK_WITH_3DES_EDE_CBC_SHA | | "00" | "8F" |
| 0x0090 | TLS_DHE_PSK_WITH_AES_128_CBC_SHA | | "00" | "90" |
| 0x0091 | TLS_DHE_PSK_WITH_AES_256_CBC_SHA | | "00" | "91" |
| 0x0092 | TLS_RSA_PSK_WITH_RC4_128_SHA | | "00" | "92" |
| 0x0093 | TLS_RSA_PSK_WITH_3DES_EDE_CBC_SHA | 11 | "00" | "93" |
| 0x0094 | TLS_RSA_PSK_WITH_AES_128_CBC_SHA | 9 | "00" | "94" |
| 0x0095 | TLS_RSA_PSK_WITH_AES_256_CBC_SHA | 10 | "00" | "95" |
| 0x009C | TLS_RSA_WITH_AES_128_GCM_SHA256 | | "00" | "9C" |
| 0x009D | TLS_RSA_WITH_AES_256_GCM_SHA384 | | "00" | "9D" |
| 0x009E | TLS_DHE_RSA_WITH_AES_128_GCM_SHA256 | | "00" | "9E" |
| 0x009F | TLS_DHE_RSA_WITH_AES_256_GCM_SHA384 | | "00" | "9F" |
| 0x00A8 | TLS_PSK_WITH_AES_128_GCM_SHA256 | 16 | "00" | "A8" |
| 0x00A9 | TLS_PSK_WITH_AES_256_GCM_SHA384 | 17 | "00" | "A9" |
| 0x00AA | TLS_DHE_PSK_WITH_AES_128_GCM_SHA256 | | "00" | "AA" |
| 0x00AB | TLS_DHE_PSK_WITH_AES_256_GCM_SHA384 | | "00" | "AB" |
| 0x00AC | TLS_RSA_PSK_WITH_AES_128_GCM_SHA256 | 18 | "00" | "AC" |
| 0x00AD | TLS_RSA_PSK_WITH_AES_256_GCM_SHA384 | 19 | "00" | "AD" |
| 0x00AE | TLS_PSK_WITH_AES_128_CBC_SHA256 | 12 | "00" | "AE" |
| 0x00AF | TLS_PSK_WITH_AES_256_CBC_SHA384 | 13 | "00" | "AF" |
| 0x00B2 | TLS_DHE_PSK_WITH_AES_128_CBC_SHA256 | | "00" | "B2" |
| 0x00B3 | TLS_DHE_PSK_WITH_AES_256_CBC_SHA384 | | "00" | "B3" |
| 0x00B6 | TLS_RSA_PSK_WITH_AES_128_CBC_SHA256 | 14 | "00" | "B6" |
| 0x00B7 | TLS_RSA_PSK_WITH_AES_256_CBC_SHA384 | 15 | "00" | "B7" |
| 0x00BA | TLS_RSA_WITH_CAMELLIA_128_CBC_SHA256 | | "00" | "BA" |
| 0x00BE | TLS_DHE_RSA_WITH_CAMELLIA_128_CBC_SHA256 | | "00" | "BE" |
| 0x00C0 | TLS_RSA_WITH_CAMELLIA_256_CBC_SHA256 | | "00" | "C0" |
| 0x00C4 | TLS_DHE_RSA_WITH_CAMELLIA_256_CBC_SHA256 | | "00" | "C4" |
| 0xC002 | TLS_ECDH_ECDSA_WITH_RC4_128_SHA | | "C0" | "02" |
| 0xC003 | TLS_ECDH_ECDSA_WITH_3DES_EDE_CBC_SHA | | "C0" | "03" |
| 0xC004 | TLS_ECDH_ECDSA_WITH_AES_128_CBC_SHA | | "C0" | "04" |
| 0xC005 | TLS_ECDH_ECDSA_WITH_AES_256_CBC_SHA | | "C0" | "05" |
| 0xC007 | TLS_ECDHE_ECDSA_WITH_RC4_128_SHA | | "C0" | "07" |
| 0xC008 | TLS_ECDHE_ECDSA_WITH_3DES_EDE_CBC_SHA | 20 | "C0" | "08" |
| 0xC009 | TLS_ECDHE_ECDSA_WITH_AES_128_CBC_SHA | 21 | "C0" | "09" |
| 0xC00A | TLS_ECDHE_ECDSA_WITH_AES_256_CBC_SHA | 22 | "C0" | "0A" |
| 0xC00C | TLS_ECDH_RSA_WITH_RC4_128_SHA | | "C0" | "0C" |
| 0xC00D | TLS_ECDH_RSA_WITH_3DES_EDE_CBC_SHA | | "C0" | "0D" |
| 0xC00E | TLS_ECDH_RSA_WITH_AES_128_CBC_SHA | | "C0" | "0E" |
| 0xC00F | TLS_ECDH_RSA_WITH_AES_256_CBC_SHA | | "C0" | "0F" |
| 0xC010 | TLS_ECDHE_RSA_WITH_NULL_SHA | | "C0" | "10" |
| 0xC011 | TLS_ECDHE_RSA_WITH_RC4_128_SHA | | "C0" | "11" |
| 0xC012 | TLS_ECDHE_RSA_WITH_3DES_EDE_CBC_SHA | 23 | "C0" | "12" |
| 0xC013 | TLS_ECDHE_RSA_WITH_AES_128_CBC_SHA | 24 | "C0" | "13" |
| 0xC014 | TLS_ECDHE_RSA_WITH_AES_256_CBC_SHA | 25 | "C0" | "14" |
| 0xC017 | TLS_ECDH_anon_WITH_3DES_EDE_CBC_SHA | | "C0" | "17" |
| 0xC018 | TLS_ECDH_anon_WITH_AES_128_CBC_SHA | | "C0" | "18" |
| 0xC019 | TLS_ECDH_anon_WITH_AES_256_CBC_SHA | | "C0" | "19" |
| 0xC023 | TLS_ECDHE_ECDSA_WITH_AES_128_CBC_SHA256 | 26 | "C0" | "23" |
| 0xC024 | TLS_ECDHE_ECDSA_WITH_AES_256_CBC_SHA384 | 27 | "C0" | "24" |
| 0xC025 | TLS_ECDH_ECDSA_WITH_AES_128_CBC_SHA256 | | "C0" | "25" |

| Cipher suite IANA code | Cipher suite name | Legacy cipher suite configuration | IANA enumeration cipher suite configuration | |
|---------------------------|--|---|---|---------------------|
| | | | <legacy_cs> | <iana_b1> <iana_b2> |
| 0xC026 | TLS_ECDH_ECDSA_WITH_AES_256_CBC_SHA384 | | "C0" | "26" |
| 0xC027 | TLS_ECDHE_RSA_WITH_AES_128_CBC_SHA256 | 28 | "C0" | "27" |
| 0xC028 | TLS_ECDHE_RSA_WITH_AES_256_CBC_SHA384 | 29 | "C0" | "28" |
| 0xC029 | TLS_ECDH_RSA_WITH_AES_128_CBC_SHA256 | | "C0" | "29" |
| 0xC02A | TLS_ECDH_RSA_WITH_AES_256_CBC_SHA384 | | "C0" | "2A" |
| 0xC02B | TLS_ECDHE_ECDSA_WITH_AES_128_GCM_SHA256 | 30 | "C0" | "2B" |
| 0xC02C | TLS_ECDHE_ECDSA_WITH_AES_256_GCM_SHA384 | 31 | "C0" | "2C" |
| 0xC02D | TLS_ECDH_ECDSA_WITH_AES_128_GCM_SHA256 | | "C0" | "2D" |
| 0xC02E | TLS_ECDH_ECDSA_WITH_AES_256_GCM_SHA384 | | "C0" | "2E" |
| 0xC02F | TLS_ECDHE_RSA_WITH_AES_128_GCM_SHA256 | 32 | "C0" | "2F" |
| 0xC030 | TLS_ECDHE_RSA_WITH_AES_256_GCM_SHA384 | 33 | "C0" | "30" |
| 0xC031 | TLS_ECDH_RSA_WITH_AES_128_GCM_SHA256 | | "C0" | "31" |
| 0xC032 | TLS_ECDH_RSA_WITH_AES_256_GCM_SHA384 | | "C0" | "32" |
| 0xC033 | TLS_ECDHE_PSK_WITH_RC4_128_SHA | | "C0" | "33" |
| 0xC034 | TLS_ECDHE_PSK_WITH_3DES_EDE_CBC_SHA | | "C0" | "34" |
| 0xC035 | TLS_ECDHE_PSK_WITH_AES_128_CBC_SHA | | "C0" | "35" |
| 0xC036 | TLS_ECDHE_PSK_WITH_AES_256_CBC_SHA | | "C0" | "36" |
| 0xC037 | TLS_ECDHE_PSK_WITH_AES_128_CBC_SHA256 | | "C0" | "37" |
| 0xC038 | TLS_ECDHE_PSK_WITH_AES_256_CBC_SHA384 | | "C0" | "38" |
| 0xC072 | TLS_ECDHE_ECDSA_WITH_CAMELLIA_128_CBC_SHA256 | | "C0" | "72" |
| 0xC073 | TLS_ECDHE_ECDSA_WITH_CAMELLIA_256_CBC_SHA384 | | "C0" | "73" |
| 0xC074 | TLS_ECDH_ECDSA_WITH_CAMELLIA_128_CBC_SHA256 | | "C0" | "74" |
| 0xC075 | TLS_ECDH_ECDSA_WITH_CAMELLIA_256_CBC_SHA384 | | "C0" | "75" |
| 0xC076 | TLS_ECDHE_RSA_WITH_CAMELLIA_128_CBC_SHA256 | | "C0" | "76" |
| 0xC077 | TLS_ECDHE_RSA_WITH_CAMELLIA_256_CBC_SHA384 | | "C0" | "77" |
| 0xC078 | TLS_ECDH_RSA_WITH_CAMELLIA_128_CBC_SHA256 | | "C0" | "78" |
| 0xC079 | TLS_ECDH_RSA_WITH_CAMELLIA_256_CBC_SHA384 | | "C0" | "79" |
| 0xC07A | TLS_RSA_WITH_CAMELLIA_128_GCM_SHA256 | | "C0" | "7A" |
| 0xC07B | TLS_RSA_WITH_CAMELLIA_256_GCM_SHA384 | | "C0" | "7B" |
| 0xC07C | TLS_DHE_RSA_WITH_CAMELLIA_128_GCM_SHA256 | | "C0" | "7C" |
| 0xC07D | TLS_DHE_RSA_WITH_CAMELLIA_256_GCM_SHA384 | | "C0" | "7D" |
| 0xC086 | TLS_ECDHE_ECDSA_WITH_CAMELLIA_128_GCM_SHA256 | | "C0" | "86" |
| 0xC087 | TLS_ECDHE_ECDSA_WITH_CAMELLIA_256_GCM_SHA384 | | "C0" | "87" |
| 0xC088 | TLS_ECDH_ECDSA_WITH_CAMELLIA_128_GCM_SHA256 | | "C0" | "88" |
| 0xC089 | TLS_ECDH_ECDSA_WITH_CAMELLIA_256_GCM_SHA384 | | "C0" | "89" |
| 0xC08A | TLS_ECDHE_RSA_WITH_CAMELLIA_128_GCM_SHA256 | | "C0" | "8A" |
| 0xC08B | TLS_ECDHE_RSA_WITH_CAMELLIA_256_GCM_SHA384 | | "C0" | "8B" |
| 0xC08C | TLS_ECDH_RSA_WITH_CAMELLIA_128_GCM_SHA256 | | "C0" | "8C" |
| 0xC08D | TLS_ECDH_RSA_WITH_CAMELLIA_256_GCM_SHA384 | | "C0" | "8D" |
| 0xC08E | TLS_PSK_WITH_CAMELLIA_128_GCM_SHA256 | | "C0" | "8E" |
| 0xC08F | TLS_PSK_WITH_CAMELLIA_256_GCM_SHA384 | | "C0" | "8F" |
| 0xC090 | TLS_DHE_PSK_WITH_CAMELLIA_128_GCM_SHA256 | | "C0" | "90" |
| 0xC091 | TLS_DHE_PSK_WITH_CAMELLIA_256_GCM_SHA384 | | "C0" | "91" |
| 0xC092 | TLS_RSA_PSK_WITH_CAMELLIA_128_GCM_SHA256 | | "C0" | "92" |
| 0xC093 | TLS_RSA_PSK_WITH_CAMELLIA_256_GCM_SHA384 | | "C0" | "93" |
| 0xC094 | TLS_PSK_WITH_CAMELLIA_128_CBC_SHA256 | | "C0" | "94" |
| 0xC095 | TLS_PSK_WITH_CAMELLIA_256_CBC_SHA384 | | "C0" | "95" |
| 0xC096 | TLS_DHE_PSK_WITH_CAMELLIA_128_CBC_SHA256 | | "C0" | "96" |
| 0xC097 | TLS_DHE_PSK_WITH_CAMELLIA_256_CBC_SHA384 | | "C0" | "97" |

| Cipher suite IANA code | Cipher suite name | Legacy cipher suite configuration | IANA enumeration cipher suite configuration | |
|---------------------------|--|---|---|-----------|
| | | <legacy_cs> | <iana_b1> | <iana_b2> |
| 0xC098 | TLS_RSA_PSK_WITH_CAMELLIA_128_CBC_SHA256 | | "C0" | "98" |
| 0xC099 | TLS_RSA_PSK_WITH_CAMELLIA_256_CBC_SHA384 | | "C0" | "99" |
| 0xC09A | TLS_ECDHE_PSK_WITH_CAMELLIA_128_CBC_SHA256 | | "C0" | "9A" |
| 0xC09B | TLS_ECDHE_PSK_WITH_CAMELLIA_256_CBC_SHA384 | | "C0" | "9B" |
| 0xC09C | TLS_RSA_WITH_AES_128_CCM | | "C0" | "9C" |
| 0xC09D | TLS_RSA_WITH_AES_256_CCM | | "C0" | "9D" |
| 0xC09E | TLS_DHE_RSA_WITH_AES_128_CCM | | "C0" | "9E" |
| 0xC09F | TLS_DHE_RSA_WITH_AES_256_CCM | | "C0" | "9F" |
| 0xC034 | TLS_ECDHE_PSK_WITH_3DES_EDE_CBC_SHA | | "C0" | "34" |
| 0xC035 | TLS_ECDHE_PSK_WITH_AES_128_CBC_SHA | | "C0" | "35" |
| 0xC036 | TLS_ECDHE_PSK_WITH_AES_256_CBC_SHA | | "C0" | "36" |
| 0xC037 | TLS_ECDHE_PSK_WITH_AES_128_CBC_SHA256 | | "C0" | "37" |
| 0xC038 | TLS_ECDHE_PSK_WITH_AES_256_CBC_SHA384 | | "C0" | "38" |
| 0xC0A0 | TLS_RSA_WITH_AES_128_CCM_8 | | "C0" | "A0" |
| 0xC0A1 | TLS_RSA_WITH_AES_256_CCM_8 | | "C0" | "A1" |
| 0xC0A2 | TLS_DHE_RSA_WITH_AES_128_CCM_8 | | "C0" | "A2" |
| 0xC0A3 | TLS_DHE_RSA_WITH_AES_256_CCM_8 | | "C0" | "A3" |
| 0xC0A4 | TLS_PSK_WITH_AES_128_CCM | | "C0" | "A4" |
| 0xC0A5 | TLS_PSK_WITH_AES_256_CCM | | "C0" | "A5" |
| 0xC0A6 | TLS_DHE_PSK_WITH_AES_128_CCM | | "C0" | "A6" |
| 0xC0A7 | TLS_DHE_PSK_WITH_AES_256_CCM | | "C0" | "A7" |
| 0xC0A8 | TLS_PSK_WITH_AES_128_CCM_8 | | "C0" | "A8" |
| 0xC0A9 | TLS_PSK_WITH_AES_256_CCM_8 | | "C0" | "A9" |
| 0xC0AA | TLS_PSK_DHE_WITH_AES_128_CCM_8 | | "C0" | "AA" |
| 0xC0AB | TLS_PSK_DHE_WITH_AES_256_CCM_8 | | "C0" | "AB" |
| 0xC0AC | TLS_ECDHE_ECDSA_WITH_AES_128_CCM | | "C0" | "AC" |
| 0xC0AD | TLS_ECDHE_ECDSA_WITH_AES_256_CCM | | "C0" | "AD" |
| 0xC0AE | TLS_ECDHE_ECDSA_WITH_AES_128_CCM_8 | | "C0" | "AE" |
| 0xC0AF | TLS_ECDHE_ECDSA_WITH_AES_256_CCM_8 | | "C0" | "AF" |
| 0xCCA8 | TLS_ECDHE_RSA_WITH_CHACHA20_POL1305_SHA256 | | "CC" | "A8" |
| 0xCCA9 | TLS_ECDHE_ECDSA_WITH_CHACHA20_POL1305_SHA256 | | "CC" | "A9" |
| 0xCCAA | TLS_DHE_RSA_WITH_CHACHA20_POL1305_SHA256 | | "CC" | "AA" |
| 0xCCAB | TLS_PSK_WITH_CHACHA20_POL1305_SHA256 | | "CC" | "AB" |
| 0xCCAC | TLS_ECDHE_PSK_WITH_CHACHA20_POL1305_SHA256 | | "CC" | "AC" |
| 0xCCAD | TLS_DHE_PSK_WITH_CHACHA20_POL1305_SHA256 | | "CC" | "AD" |
| 0xCCAE | TLS_RSA_PSK_WITH_CHACHA20_POL1305_SHA256 | | "CC" | "AE" |

Table 30: Supported cipher suite

20.3.4 AT+USECMNG command example



SARA-R4 / SARA-N4

Here below is reported an example with a DER encoded trusted root certificate. This example is applicable only for an AT terminal where it is possible to convert the HEX string to binary format (i.e. m-center).

| Command | Response | Description |
|--|---|---|
| Step 1: Import a trusted root certificate using the stream of byte similar to +UDWNFILE | | |
| AT+USECMNG=0,0, "DERCertificate",947 | > | Start the data transfer using the stream of byte. |
| DER encoded trusted root certificate data . The <CR><LF> shall be ignored during the import. | +USECMNG: 1,0,"DERCertificate","8ccadc0b22cef5be72ac411a11a8d812" OK | Input DER formatted trusted root certificate data bytes. Output MD5 hash string of the stored trusted root certificate DER. |

| Command | Response | Description |
|---|--|--|
| Step 2: List all available certificates and private keys | | |
| AT+USECMNG=3 | CA, "DERCertificate","thawte Primary Root CA","2036/07/17" OK | List all available certificates and private keys. |
| Step 3: Set the security profile 2 validation level to trusted root | | |
| AT+USECPRF=2,0,1 | OK | Security profile 2 has the validation level set to trusted root. |
| Step 4: Set the security profile 2 trusted root certificate to the CA certificate imported as "DERCertificate" | | |
| AT+USECPRF=2,3, "DERCertificate" | OK | Security profile 2 will use the CA certificate imported as "DERCertificate" for server certificate validation. |
| Step 5: Use the configured USECMNG profile 2 with the UHTTP application | | |
| AT+UHTTP=0,1,"www.ssl_tls_test_server.com" | OK | Configure the UHTTP server name. |
| AT+UHTTP=0,6,1,2 | OK | Enable the SSL/TLS for the UHTTP profile #0 and specify the SSL/TLS security profile 2. |
| AT+UHTTPC=0,1,"/", "https.resp" | OK | Execute the HTTP GET command. |
| | +UUHTTPCR: 0,1,1 | HTTP GET URC response. |

In the above example the following DER encoded trusted certificate is used:

```

308203af30820297a0030201020210083be056904246b1a1756ac95991c74a300d06
092a864886f70d01010505003061310b300906035504061302555331153013060355
040a130c446967694365727420496e6331193017060355040b1310777772e646967
69636572742e636f6d3120301e06035504031317446967694365727420476c6f6261
6c20526f6f74204341301e170d3036313131303030303030305a170d333131313130
3030303030305a3061310b300906035504061302555331153013060355040a130c44
6967694365727420496e6331193017060355040b1310777772e6469676963657274
2e636f6d3120301e06035504031317446967694365727420476c6f62616c20526f6f
7420434130820122300d06092a864886f70d010105000382010f003082010a0282
010100e23be11172dea8a4d3a357aa50a28f0b7790c9a2a5ee12ce965b010920cc01
93a74e30b753f743c46900579de28d22dd870640008109cece1b83bfdfcd3b7146e2
d666c705b37627168f7b9e1e957deeb748a308dad6af7a0c3906657f4a5d1fbc17f8
abbeee28d7747f7a78995985686e5c23324bbf4ec0e85a6de370bf7710bffc01f685
d9a844105832a97518d5d1a2be47e2276af49a33f84908608bd45fb43a84bfa1aa4a
4c7d3ecf4f5f6c765ea04b37919edc22e66dce141a8e6acbfecdb3146417c75b299e
32bfff2eefad30b42d4abb74132da0cd4efff881d5bb8d583fb51be84928a270da3104
ddf7b216f24c0a4e07a8ed4a3d5eb57fa390c3af270203010001a3633061300e0603
551d0f0101ff040403020186300f0603551d130101ff040530030101ff301d060355
1d0e0416041403de503556d14cbb66f0a3e21b1bc397b23dd155301f0603551d2304
183016801403de503556d14cbb66f0a3e21b1bc397b23dd155300d06092a864886f7
0d01010505000382010100cb9c37aa4813120afadd449c4f52b0f4dfae04f5797908
a32418fc4b2b84c02db9d5c7fef4c11f58cbb86d9c7a74e79829ab11b5e370a0a1cd
4c8899938c9170e2ab0f1cbe93a9ff63d5e40760d3a3bf9d5b09f1d58ee353f48e63
fa3fa7dbb466df6266d6d16e418df22db5ea774a9f9d58e22b59c04023ed2d288245
3e7954922698e08048a837eff0d6796016deace80ecd6eac4417382f49dae1453e2a
b93653cf3a5006f72ee8c4574 96c612118d504ad783c2c3a806ba7ebaf1514e9d88
9c1b9386ce2916c8aff64b977255730c01b24a3e1dce9df477cb5b424080530ec2db
d0bbf45bf50b9a9f3eb980112adc888c698345f8d0a3cc6e9d595956dde

```

20.3.5 Notes

Due to significant memory fingerprint of an SSL/TLS connection, the number of concurrent SSL/TLS connections is limited. The USECMNG and the underlying SSL/TLS infrastructure allows 4 concurrent SSL/TLS connections (i.e. 4 HTTPS requests or 2 HTTPS and 2 FTPS request).

20.3.6 Pre-Shared Key (PSK) generation +USECPSK

| +USECPSK | | | | | | |
|-------------------|--|---------------------|-----------------------|-----------------------|----------------------|------------------------|
| Modules | SARA-R410M-63B SARA-R410M-73B SARA-R410M-83B SARA-R422M8S SARA-R422S | | | | | |
| Attributes | Syntax | PIN required | Settings saved | Can be aborted | Response time | Error reference |
| | full | No | No | No | < 30 s | +CME Error |

20.3.6.1 Description

Generate a PSK identity and key.



SARA-R422M8S / SARA-R422S

The AT command response time can be up to 150 s due to "security heartbeat" message operation. For more details on when this scenario occurs, see the the [+USECCONN](#) AT command.

20.3.6.2 Syntax

| Type | Syntax | Response | Example |
|------|-----------------------|--|--|
| Set | AT+USECPSK=<psk_size> | +USECPSK: <psk_id>,<psk> OK | AT+USECPSK=16 +USECPSK: "010203040A0B0C0D0 E0F10111213","01020304050607080 9000A0B0C0D0E0F" OK |
| Test | AT+USECPSK=? | +USECPSK: (list of supported <psk_ size>s) OK | +USECPSK: (16,32) OK |

20.3.6.3 Defined values

| Parameter | Type | Description |
|------------|--------|---|
| <psk_size> | Number | Size requested for the <psk> parameter expressed in bytes. The allowed values are 16 and 32. |
| <psk_id> | String | PSK key identity in hexadecimal format. The maximum size is 32 hex (64 bytes). For more details, see the +USECPRF (<op_code>=9) AT command. |
| <psk> | String | PSK key in hexadecimal format. For more details, see the +USECPRF (<op_code>=8) AT command. |

20.3.7 Local encryption from AT interface +USECDATAENC

| +USECDATAENC | | | | | | |
|-------------------|--|---------------------|-----------------------|-----------------------|----------------------|------------------------|
| Modules | SARA-R410M-63B SARA-R410M-73B SARA-R410M-83B SARA-R422M8S SARA-R422S | | | | | |
| Attributes | Syntax | PIN required | Settings saved | Can be aborted | Response time | Error reference |
| | full | No | No | No | < 30 s | +CME Error |

20.3.7.1 Description

Executes the local encryption of the plain data provided by the AT interface. The <payload_length> parameter defines the data length which will be provided via the AT interface and is limited to 8192 bytes. The stream of bytes can be entered after the '>' prompt has been provided to the user. The data transfer is terminated exactly when <payload_length> bytes have been sent. Once the specified number of bytes have been sent, and the encryption is finished, the AT interface is used to output the encrypted data.

If the <filename> parameter is given then the encrypted data will be written to the file in the file system. If the file already exists the existing file will be overwritten. If the data transfer over the AT interface is stopped or paused for some reason, the interface waits 20 s before aborting the data encryption.



A total of a hundred local encryption/decryption sessions are granted for free as trial period, unless the module has already successfully registered with the security server. If the hundred sessions are used and the module is not registered with the security server, an error result code is returned when local encryption or decryption are used.



SARA-R422M8S / SARA-R422S

The AT command response time can be up to 150 s due to "security heartbeat" message operation. For more details on when this scenario occurs, see the [+USECCONN](#) AT command.

20.3.7.2 Syntax

| Type | Syntax | Response | Example |
|----------------------------|---|--|--|
| Generic syntax | | | |
| Set | AT+USECDATAENC=<payload_length>[,<filename>] > <unencrypted_data> | < [+USECDATAENC: <enc_data_length>,<encrypted_data> OK | AT+USECDATAENC=512 > 512 bytes of data to be encrypted < +USECDATAENC: 512,"512 bytes of encrypted data" OK |
| AT interface syntax | | | |
| Set | AT+USECDATAENC=<payload_length> > <unencrypted_data> | < +USECDATAENC: <enc_data_length>,<encrypted_data> OK | AT+USECDATAENC=512 > 512 bytes of data to be encrypted < +USECDATAENC: 512,"512 bytes of encrypted data" OK |
| File system syntax | | | |
| Set | AT+USECDATAENC=<payload_length>,<filename> > <unencrypted_data> | < OK | AT+USECDATAENC=512,"encfile" > 512 bytes of data to be encrypted < OK |
| Test | AT+USECDATAENC=? | +USECDATAENC: (list of supported <payload_length>s) OK | +USECDATAENC: (1-8192) OK |

20.3.7.3 Defined values

| Parameter | Type | Description |
|--------------------|--------|--|
| <payload_length> | Number | Number of bytes to be sent. |
| <filename> | String | Filename where to store the encrypted data. See File system limits . |
| <unencrypted_data> | String | Stream of bytes. |
| <enc_data_length> | Number | Number of encrypted bytes returned. |
| <encrypted_data> | String | ASCII string representing the encrypted data of <enc_data_length> characters in the range [0x00,0xFF]. |

20.3.8 Local encryption from a file +USECFILEENC

| +USECFILEENC | | | | | | |
|---------------------|--|--------------|----------------|----------------|---------------|-----------------|
| Modules | SARA-R410M-63B SARA-R410M-73B SARA-R410M-83B SARA-R422M8S SARA-R422S | | | | | |
| Attributes | Syntax | PIN required | Settings saved | Can be aborted | Response time | Error reference |
| | full | No | No | No | < 30 s | +CME Error |

20.3.8.1 Description

Executes the local encryption of the plain data stored in a file. The file size is limited to 8192 bytes. Once the file has been read and the encryption is finished the AT interface is used to output the encrypted data.

If the <out_file> parameter is given then the encrypted data will be written to the file in the file system. If the file already exists the existing file will be overwritten.



A total of a hundred local encryption/decryption sessions are granted for free as trial period, unless the module has already successfully registered with the security server. If the hundred sessions are used and the module is not registered with the security server, an error result code is returned when local encryption or decryption are used.

SARA-R422M8S / SARA-R422S

The AT command response time can be up to 150 s due to "security heartbeat" message operation. For more details on when this scenario occurs, see the [+USECCONN](#) AT command.

20.3.8.2 Syntax

| Type | Syntax | Response | Example |
|----------------------------|---|--|---|
| Generic syntax | | | |
| Set | AT+USECFILEENC=<filename>[, <out_file>] | [+USECFILEENC: <enc_data_length>,<encrypted_data>] OK | AT+USECFILEENC="file_to_encrypt" +USECFILEENC: 512,"512 bytes of encrypted data" OK |
| AT interface syntax | | | |
| Set | AT+USECFILEENC=<filename> | +USECFILEENC: <enc_data_length>,<encrypted_data> OK | AT+USECFILEENC="file_to_encrypt" +USECFILEENC: 512,"512 bytes of encrypted data" OK |
| File system syntax | | | |
| Set | AT+USECFILEENC=<filename>,<out_file> | OK | AT+USECFILEENC="file_to_encrypt","file_to_store_data" OK |

20.3.8.3 Defined values

| Parameter | Type | Description |
|-------------------|--------|---|
| <filename> | String | Filename of the file containing the plain data. |
| <out_file> | String | Filename where to store the encrypted data. For more details on file system limitations, see File system limits . |
| <enc_data_length> | Number | Number of encrypted bytes returned. |
| <encrypted_data> | String | ASCII string representing the encrypted data of <enc_data_length> characters in the range [0x00,0xFF]. |

20.3.9 Local decryption from AT interface +USECDATADEC

| +USECDATADEC | | | | | | |
|---------------------|--|--------------|----------------|----------------|---------------|----------------------------|
| Modules | SARA-R410M-63B SARA-R410M-73B SARA-R410M-83B SARA-R422M8S SARA-R422S | | | | | |
| Attributes | Syntax | PIN required | Settings saved | Can be aborted | Response time | Error reference |
| | full | No | No | No | < 30 s | +CME Error |

20.3.9.1 Description

Executes the local decryption of the encrypted data provided by the AT interface. The <payload_length> parameter defines the data length which will be provided via the AT interface and is limited to 8224 bytes. The stream of bytes can be entered after the '>' prompt has been provided to the user. The data transfer is terminated exactly when <payload_length> bytes have been sent. Once the specified number of bytes have been sent, and the decryption is finished, the AT interface is used to output the decrypted data.

If the <filename> parameter is given then the decrypted data will be written to the file in the file system. If the file already exists the existing file will be overwritten. If the data transfer over the AT interface is stopped or paused for some reason, the interface waits 20 s before aborting the data encryption.



A total of a hundred local encryption/decryption sessions are granted for free as trial period, unless the module has already successfully registered with the security server. If the hundred sessions are used and the module is not registered with the security server, an error result code is returned when local encryption or decryption are used.

SARA-R422M8S / SARA-R422S

The AT command response time can be up to 150 s due to "security heartbeat" message operation. For more details on when this scenario occurs, see the [+USECCONN](#) AT command.

20.3.9.2 Syntax

| Type | Syntax | Response | Example |
|----------------------------|---|---|--|
| Set | AT+USECDATADEC=<payload_length>[,<filename>] > <encrypted_data> | < [+USECDATADEC: <dec_data_length>,<decrypted_data>] OK | AT+USECDATADEC=512 > 512 bytes of data to be decrypted < +USECDATADEC: 512,"512 bytes of decrypted data" OK |
| AT interface syntax | | | |
| Set | AT+USECDATADEC=<payload_length> > <encrypted_data> | < +USECDATADEC: <dec_data_length>,<decrypted_data> OK | AT+USECDATADEC=512 > 512 bytes of data to be decrypted < +USECDATADEC: 512,"512 bytes of decrypted data" OK |
| File system syntax | | | |
| Set | AT+USECDATADEC=<payload_length>,<filename> > <encrypted_data> | < OK | AT+USECDATADEC=512,"decfile" > 512 bytes of data to be decrypted < OK |
| Test | AT+USECDATADEC=? | +USECDATADEC: (list of supported <payload_length>s) OK | +USECDATADEC: (1-8224) OK |

20.3.9.3 Defined values

| Parameter | Type | Description |
|-------------------|--------|---|
| <payload_length> | Number | Number of bytes to be decrypted. |
| <filename> | String | Filename where to store the decrypted data. For more details on file system limitations, see File system limits . |
| <encrypted_data> | String | Stream of bytes to be decrypted. |
| <dec_data_length> | Number | Number of decrypted bytes returned. |
| <decrypted_data> | String | ASCII string representing the decrypted data of <dec_data_length> characters in the range [0x00,0xFF]. |

20.3.10 Local decryption from a file +USECFILEDEC

| +USECFILEDEC | | | | | | |
|---------------------|--|--------------|----------------|----------------|---------------|-----------------|
| Modules | SARA-R410M-63B SARA-R410M-73B SARA-R410M-83B SARA-R422M8S SARA-R422S | | | | | |
| Attributes | Syntax | PIN required | Settings saved | Can be aborted | Response time | Error reference |
| | full | No | No | No | < 30 s | +CME Error |

20.3.10.1 Description

Executes the local decryption of the encrypted data stored in a file. The file size is limited to 8192 bytes. Once the file has been read and the decryption is finished the AT interface is used to output the decrypted data.

If the <out_file> parameter is given then the decrypted data will be written to the file in the file system. If the file already exists the existing file will be overwritten.



A total of a hundred local encryption/decryption sessions are granted for free as trial period, unless the module has already successfully registered with the security server. If the hundred sessions are used and the module is not registered with the security server, an error result code is returned when the local encryption or decryption are used.

SARA-R422M8S / SARA-R422S

The AT command response time can be up to 150 s due to "security heartbeat" message operation. For more details on when this scenario occurs, see the [+USECCONN](#) AT command.

20.3.10.2 Syntax

| Type | Syntax | Response | Example |
|----------------------------|---|--|---|
| Generic syntax | | | |
| Set | AT+USECFILEDEC=<filename>[, <out_file>] | [+USECFILEDEC: <dec_data_length>,<decrypted_data>] OK | AT+USECFILEDEC="file_to_decrypt" +USECFILEDEC: 512,"512 bytes of decrypted data" OK |
| AT interface syntax | | | |
| Set | AT+USECFILEDEC=<filename> | +USECFILEDEC: <dec_data_length>,<decrypted_data> OK | AT+USECFILEDEC="file_to_decrypt" +USECFILEDEC: 512,"512 bytes of decrypted data" OK |
| File system syntax | | | |
| Set | AT+USECFILEDEC=<filename>,<out_file> | OK | AT+USECFILEDEC="file_to_decrypt","file_to_store_data" OK |

20.3.10.3 Defined values

| Parameter | Type | Description |
|-------------------|--------|---|
| <filename> | String | Filename of the file containing the encrypted data. |
| <out_file> | String | Filename where to store the decrypted data. For more details on file system limitations, see File system limits . |
| <dec_data_length> | Number | Number of decrypted bytes returned. |
| <decrypted_data> | String | ASCII string representing the decrypted data of <dec_data_length> characters in the range [0x00,0xFF]. |

20.3.11 End-to-end encryption from AT interface +USECE2EDATAENC

| +USECE2EDATAENC | | | | | | |
|------------------------|--|--------------|----------------|----------------|---------------|----------------------------|
| Modules | SARA-R410M-63B SARA-R410M-73B SARA-R410M-83B SARA-R422M8S SARA-R422S | | | | | |
| Attributes | Syntax | PIN required | Settings saved | Can be aborted | Response time | Error reference |
| | full | No | No | No | < 30 s | +CME Error |

20.3.11.1 Description

Executes an end-to-end encryption of the plain data provided by the AT interface. The <payload_length> parameter defines the data length which will be provided via the AT interface and is limited to 8192 bytes. The stream of bytes can be entered after the '>' prompt has been provided to the user. The data transfer is terminated exactly when <payload_length> bytes have been sent. Once the specified number of bytes have been sent, and the encryption is finished, the AT interface is used to output the encrypted data.

If the <filename> parameter is given then the encrypted data is written to the indicated file system file. If the file already exists the existing file will be overwritten.

If the data transfer over the AT interface is stopped or paused for some reasons, the interface waits 20 s before aborting the data encryption.

SARA-R422M8S / SARA-R422S

The AT command response time can be up to 150 s due to "security heartbeat" message operation. For more details on when this scenario occurs, see the [+USECCONN](#) AT command.

20.3.11.2 Syntax

| Type | Syntax | Response | Example |
|-----------------------|--------|----------|---------|
| Generic syntax | | | |

| Type | Syntax | Response | Example |
|----------------------------|---|---|--|
| Set | AT+USECE2EDATAENC=<payload_ length>[,<filename>] > <unencrypted_data> | [+USECE2EDATAENC: <enc_data_ length>,<encrypted_data>] OK | AT+USECE2EDATAENC=512 > 512 bytes of data to be encrypted +USECE2EDATAENC: 544,"544 bytes of encrypted data" OK |
| AT interface syntax | | | |
| Set | AT+USECE2EDATAENC=<payload_ length> > <unencrypted_data> | +USECE2EDATAENC: <enc_data_ length>,<encrypted_data> OK | AT+USECE2EDATAENC=512 > 512 bytes of data to be encrypted +USECE2EDATAENC: 544,"544 bytes of encrypted data" OK |
| File system syntax | | | |
| Set | AT+USECE2EDATAENC=<payload_ length>,<filename> > <unencrypted_data> | OK OK | AT+USECE2EDATAENC=512, "encfile" > 512 bytes of data to be encrypted OK |
| Test | AT+USECE2EDATAENC=? | +USECE2EDATAENC: (list of supported <payload_length>s) OK | +USECE2EDATAENC: (1-8192) OK |

20.3.11.3 Defined values

| Parameter | Type | Description |
|--------------------|--------|---|
| <payload_length> | Number | Number of bytes to be encrypted. |
| <filename> | String | Filename where to store the encrypted data. For more details on file system limitations, see File system limits . |
| <unencrypted_data> | String | Stream of bytes to be encrypted. |
| <enc_data_length> | Number | Number of encrypted bytes returned. |
| <encrypted_data> | String | String of the end-to-end encrypted data of <enc_data_length> bytes. |

20.3.12 End-to-end encryption from a file +USECE2EFILEENC

| +USECE2EFILEENC | | | | | | |
|------------------------|--|--------------|----------------|----------------|---------------|-----------------|
| Modules | SARA-R410M-63B SARA-R410M-73B SARA-R410M-83B SARA-R422M8S SARA-R422S | | | | | |
| Attributes | Syntax | PIN required | Settings saved | Can be aborted | Response time | Error reference |
| | full | No | No | No | < 30 s | +CME Error |

20.3.12.1 Description

Executes an end-to-end encryption of the plain data stored in a file. The file size is limited to 8192 bytes. Once the file has been read and the encryption is finished the AT interface is used to output the encrypted data.

If the <out_file> parameter is given then the encrypted data is written to the indicated file system file. If the file already exists the existing file will be overwritten.



SARA-R422M8S / SARA-R422S

The AT command response time can be up to 150 s due to "security heartbeat" message operation. For more details on when this scenario occurs, see the [+USECCONN](#) AT command.

20.3.12.2 Syntax

| Type | Syntax | Response | Example |
|----------------------------|---|---|---|
| Generic syntax | | | |
| Set | AT+USECE2EFILEENC=<filename>[,<out_file>] | [+USECE2EFILEENC: <enc_data_length>,<encrypted_data>] OK | AT+USECE2EFILEENC="file_to_encrypt" +USECE2EFILEENC: 512,"512 bytes of encrypted data" OK |
| AT interface syntax | | | |
| Set | AT+USECE2EFILEENC=<filename> | +USECE2EFILEENC: <enc_data_length>,<encrypted_data> OK | AT+USECE2EFILEENC="file_to_encrypt" +USECE2EFILEENC: 512,"512 bytes of encrypted data" OK |
| File system syntax | | | |
| Set | AT+USECE2EFILEENC=<filename>,<out_file> | OK | AT+USECE2EFILEENC="file_to_encrypt","file_to_store_data" OK |

20.3.12.3 Defined values

| Parameter | Type | Description |
|-------------------|--------|---|
| <filename> | String | Filename of the file containing the plain data. |
| <out_file> | String | Filename where to store the encrypted data. For more details on file system limitations, see File system limits . |
| <enc_data_length> | Number | Number of encrypted bytes returned. |
| <encrypted_data> | String | String of the end-to-end encrypted data of <enc_data_length> bytes. |

20.3.13 Cipher suite applicability

20.3.13.1 Cipher suite applicability accordingly to the modules

This section provides a list of cipher suites that are available on the series modules. The allowed cipher suites can be selected when <op_code>=2 (cipher suite) with:

- the <legacy_cs> parameter
- the <legacy_cs>=99 specifying <iana_b1> and <iana_b2> parameters
- the <legacy_cs>=100 specifying <iana_b1> and <iana_b2> parameters

For proper <legacy_cs> value, see the [+USECPRF](#) AT command.

The cipher suites marked with (D) are the default cipher suites that are proposed to the server when <op_code>=2 (cipher suite) and <legacy_cs>=0. The secure connection will be established if the server supports at least one of the proposed cipher suites.

SARA-R410M-01B

The available cipher suites are presented in the following list:

- (0x002F) TLS_RSA_WITH_AES_128_CBC_SHA (D)
- (0x003C) TLS_RSA_WITH_AES_128_CBC_SHA256 (D)
- (0x0035) TLS_RSA_WITH_AES_256_CBC_SHA (D)
- (0x003D) TLS_RSA_WITH_AES_256_CBC_SHA256 (D)
- (0x000A) TLS_RSA_WITH_3DES_EDE_CBC_SHA (D)

SARA-R410M-02B / SARA-R410M-52B / SARA-R412M / SARA-N4

The available cipher suites are presented in the following list:

- (0x0004) TLS_RSA_WITH_RC4_128_MD5 (D)
- (0x0005) TLS_RSA_WITH_RC4_128_SHA (D)
- (0x0009) TLS_RSA_WITH_DES_CBC_SHA (D)
- (0x000A) TLS_RSA_WITH_3DES_EDE_CBC_SHA (D)
- (0x0015) TLS_DHE_RSA_WITH_DES_CBC_SHA (D)
- (0x0016) TLS_DHE_RSA_WITH_3DES_EDE_CBC_SHA (D)

- (0x001A) TLS_DH_anon_WITH_DES_CBC_SHA (D)
- (0x001B) TLS_DH_anon_WITH_3DES_EDE_CBC_SHA (D)
- (0x002F) TLS_RSA_WITH_AES_128_CBC_SHA (D)
- (0x0033) TLS_DHE_RSA_WITH_AES_128_CBC_SHA (D)
- (0x0034) TLS_DH_anon_WITH_AES_128_CBC_SHA (D)
- (0x0035) TLS_RSA_WITH_AES_256_CBC_SHA (D)
- (0x0039) TLS_DHE_RSA_WITH_AES_256_CBC_SHA (D)
- (0x003A) TLS_DH_anon_WITH_AES_256_CBC_SHA (D)
- (0x003C) TLS_RSA_WITH_AES_128_CBC_SHA256 (D)
- (0x003D) TLS_RSA_WITH_AES_256_CBC_SHA256 (D)
- (0x0067) TLS_DHE_RSA_WITH_AES_128_CBC_SHA256 (D)
- (0x0068) TLS_DH_DSS_WITH_AES_256_CBC_SHA256 (D)
- (0x0069) TLS_DH_RSA_WITH_AES_256_CBC_SHA256 (D)
- (0x006A) TLS_DHE_DSS_WITH_AES_256_CBC_SHA256 (D)
- (0x006B) TLS_DHE_RSA_WITH_AES_256_CBC_SHA256 (D)
- (0x006C) TLS_DH_anon_WITH_AES_128_CBC_SHA256 (D)
- (0x006D) TLS_DH_anon_WITH_AES_256_CBC_SHA256 (D)
- (0x008B) TLS_PSK_WITH_3DES_EDE_CBC_SHA (D)
- (0x008C) TLS_PSK_WITH_AES_128_CBC_SHA (D)
- (0x008D) TLS_PSK_WITH_AES_256_CBC_SHA (D)
- (0x008F) TLS_DHE_PSK_WITH_3DES_EDE_CBC_SHA (D)
- (0x0090) TLS_DHE_PSK_WITH_AES_128_CBC_SHA (D)
- (0x0091) TLS_DHE_PSK_WITH_AES_256_CBC_SHA (D)
- (0x0093) TLS_RSA_PSK_WITH_3DES_EDE_CBC_SHA (D)
- (0x0094) TLS_RSA_PSK_WITH_AES_128_CBC_SHA (D)
- (0x0095) TLS_RSA_PSK_WITH_AES_256_CBC_SHA (D)
- (0x00A8) TLS_PSK_WITH_AES_128_GCM_SHA256 (D)
- (0x00A9) TLS_PSK_WITH_AES_256_GCM_SHA384 (D)
- (0x00AA) TLS_DHE_PSK_WITH_AES_128_GCM_SHA256 (D)
- (0x00AB) TLS_DHE_PSK_WITH_AES_256_GCM_SHA384 (D)
- (0x00AC) TLS_RSA_PSK_WITH_AES_128_GCM_SHA256 (D)
- (0x00AD) TLS_RSA_PSK_WITH_AES_256_GCM_SHA384 (D)
- (0x00AE) TLS_PSK_WITH_AES_128_CBC_SHA256 (D)
- (0x00AF) TLS_PSK_WITH_AES_256_CBC_SHA384 (D)
- (0x00B2) TLS_DHE_PSK_WITH_AES_128_CBC_SHA256 (D)
- (0x00B3) TLS_DHE_PSK_WITH_AES_256_CBC_SHA384 (D)
- (0x00B6) TLS_RSA_PSK_WITH_AES_128_CBC_SHA256 (D)
- (0x00B7) TLS_RSA_PSK_WITH_AES_256_CBC_SHA384 (D)
- (0xC003) TLS_ECDH_ECDSA_WITH_3DES_EDE_CBC_SHA (D)
- (0xC004) TLS_ECDH_ECDSA_WITH_AES_128_CBC_SHA (D)
- (0xC005) TLS_ECDH_ECDSA_WITH_AES_256_CBC_SHA (D)
- (0xC008) TLS_ECDHE_ECDSA_WITH_3DES_EDE_CBC_SHA (D)
- (0xC009) TLS_ECDHE_ECDSA_WITH_AES_128_CBC_SHA (D)
- (0xC00A) TLS_ECDHE_ECDSA_WITH_AES_256_CBC_SHA (D)
- (0xC00D) TLS_ECDH_RSA_WITH_3DES_EDE_CBC_SHA (D)
- (0xC00E) TLS_ECDH_RSA_WITH_AES_128_CBC_SHA (D)
- (0xC00F) TLS_ECDH_RSA_WITH_AES_256_CBC_SHA (D)
- (0xC012) TLS_ECDHE_RSA_WITH_3DES_EDE_CBC_SHA (D)
- (0xC013) TLS_ECDHE_RSA_WITH_AES_128_CBC_SHA (D)
- (0xC014) TLS_ECDHE_RSA_WITH_AES_256_CBC_SHA (D)
- (0xC017) TLS_ECDH_anon_WITH_3DES_EDE_CBC_SHA (D)
- (0xC018) TLS_ECDH_anon_WITH_AES_128_CBC_SHA (D)
- (0xC019) TLS_ECDH_anon_WITH_AES_256_CBC_SHA (D)

- (0xC023) TLS_ECDHE_ECDSA_WITH_AES_128_CBC_SHA256 (D)
- (0xC024) TLS_ECDHE_ECDSA_WITH_AES_256_CBC_SHA384 (D)
- (0xC025) TLS_ECDH_ECDSA_WITH_AES_128_CBC_SHA256 (D)
- (0xC026) TLS_ECDH_ECDSA_WITH_AES_256_CBC_SHA384 (D)
- (0xC027) TLS_ECDHE_RSA_WITH_AES_128_CBC_SHA256 (D)
- (0xC028) TLS_ECDHE_RSA_WITH_AES_256_CBC_SHA384 (D)
- (0xC029) TLS_ECDH_RSA_WITH_AES_128_CBC_SHA256 (D)
- (0xC02A) TLS_ECDH_RSA_WITH_AES_256_CBC_SHA384 (D)
- (0xC02B) TLS_ECDHE_ECDSA_WITH_AES_128_GCM_SHA256 (D)
- (0xC02C) TLS_ECDHE_ECDSA_WITH_AES_256_GCM_SHA384 (D)
- (0xC02D) TLS_ECDH_ECDSA_WITH_AES_128_GCM_SHA256 (D)
- (0xC02E) TLS_ECDH_ECDSA_WITH_AES_256_GCM_SHA384 (D)
- (0xC02F) TLS_ECDHE_RSA_WITH_AES_128_GCM_SHA256 (D)
- (0xC030) TLS_ECDHE_RSA_WITH_AES_256_GCM_SHA384 (D)
- (0xC031) TLS_ECDH_RSA_WITH_AES_128_GCM_SHA256 (D)
- (0xC032) TLS_ECDH_RSA_WITH_AES_256_GCM_SHA384 (D)
- (0xC0AE) TLS_ECDHE_ECDSA_WITH_AES_128_CCM_8 (D)

SARA-R410M-63B / SARA-R410M-73B / SARA-R410M-83B

The available cipher suites are presented in the following list:

- (0x0004) TLS_RSA_WITH_RC4_128_MD5
- (0x0005) TLS_RSA_WITH_RC4_128_SHA
- (0x0009) TLS_RSA_WITH_DES_CBC_SHA
- (0x000A) TLS_RSA_WITH_3DES_EDE_CBC_SHA
- (0x0015) TLS_DHE_RSA_WITH_DES_CBC_SHA
- (0x0016) TLS_DHE_RSA_WITH_3DES_EDE_CBC_SHA
- (0x001A) TLS_DH_anon_WITH_DES_CBC_SHA
- (0x001B) TLS_DH_anon_WITH_3DES_EDE_CBC_SHA
- (0x002F) TLS_RSA_WITH_AES_128_CBC_SHA
- (0x0033) TLS_DHE_RSA_WITH_AES_128_CBC_SHA
- (0x0034) TLS_DH_anon_WITH_AES_128_CBC_SHA
- (0x0035) TLS_RSA_WITH_AES_256_CBC_SHA
- (0x0039) TLS_DHE_RSA_WITH_AES_256_CBC_SHA
- (0x003A) TLS_DH_anon_WITH_AES_256_CBC_SHA
- (0x003C) TLS_RSA_WITH_AES_128_CBC_SHA256 (D)
- (0x003D) TLS_RSA_WITH_AES_256_CBC_SHA256 (D)
- (0x0067) TLS_DHE_RSA_WITH_AES_128_CBC_SHA256 (D)
- (0x0068) TLS_DH_DSS_WITH_AES_256_CBC_SHA256
- (0x0069) TLS_DH_RSA_WITH_AES_256_CBC_SHA256
- (0x006A) TLS_DHE_DSS_WITH_AES_256_CBC_SHA256
- (0x006B) TLS_DHE_RSA_WITH_AES_256_CBC_SHA256 (D)
- (0x006C) TLS_DH_anon_WITH_AES_128_CBC_SHA256
- (0x006D) TLS_DH_anon_WITH_AES_256_CBC_SHA256
- (0x008B) TLS_PSK_WITH_3DES_EDE_CBC_SHA
- (0x008C) TLS_PSK_WITH_AES_128_CBC_SHA (D)
- (0x008D) TLS_PSK_WITH_AES_256_CBC_SHA (D)
- (0x008F) TLS_DHE_PSK_WITH_3DES_EDE_CBC_SHA
- (0x0090) TLS_DHE_PSK_WITH_AES_128_CBC_SHA
- (0x0091) TLS_DHE_PSK_WITH_AES_256_CBC_SHA (D)
- (0x0093) TLS_RSA_PSK_WITH_3DES_EDE_CBC_SHA
- (0x0094) TLS_RSA_PSK_WITH_AES_128_CBC_SHA
- (0x0095) TLS_RSA_PSK_WITH_AES_256_CBC_SHA
- (0x00A8) TLS_PSK_WITH_AES_128_GCM_SHA256
- (0x00A9) TLS_PSK_WITH_AES_256_GCM_SHA384

- (0x00AA) TLS_DHE_PSK_WITH_AES_128_GCM_SHA256
- (0x00AB) TLS_DHE_PSK_WITH_AES_256_GCM_SHA384
- (0x00AC) TLS_RSA_PSK_WITH_AES_128_GCM_SHA256
- (0x00AD) TLS_RSA_PSK_WITH_AES_256_GCM_SHA384
- (0x00AE) TLS_PSK_WITH_AES_128_CBC_SHA256
- (0x00AF) TLS_PSK_WITH_AES_256_CBC_SHA384
- (0x00B2) TLS_DHE_PSK_WITH_AES_128_CBC_SHA256
- (0x00B3) TLS_DHE_PSK_WITH_AES_256_CBC_SHA384
- (0x00B6) TLS_RSA_PSK_WITH_AES_128_CBC_SHA256
- (0x00B7) TLS_RSA_PSK_WITH_AES_256_CBC_SHA384
- (0xC003) TLS_ECDH_ECDSA_WITH_3DES_EDE_CBC_SHA
- (0xC004) TLS_ECDH_ECDSA_WITH_AES_128_CBC_SHA
- (0xC005) TLS_ECDH_ECDSA_WITH_AES_256_CBC_SHA
- (0xC008) TLS_ECDHE_ECDSA_WITH_3DES_EDE_CBC_SHA
- (0xC009) TLS_ECDHE_ECDSA_WITH_AES_128_CBC_SHA
- (0xC00A) TLS_ECDHE_ECDSA_WITH_AES_256_CBC_SHA
- (0xC00D) TLS_ECDH_RSA_WITH_3DES_EDE_CBC_SHA
- (0xC00E) TLS_ECDH_RSA_WITH_AES_128_CBC_SHA
- (0xC00F) TLS_ECDH_RSA_WITH_AES_256_CBC_SHA
- (0xC012) TLS_ECDHE_RSA_WITH_3DES_EDE_CBC_SHA
- (0xC013) TLS_ECDHE_RSA_WITH_AES_128_CBC_SHA
- (0xC014) TLS_ECDHE_RSA_WITH_AES_256_CBC_SHA
- (0xC017) TLS_ECDH_anon_WITH_3DES_EDE_CBC_SHA
- (0xC018) TLS_ECDH_anon_WITH_AES_128_CBC_SHA
- (0xC019) TLS_ECDH_anon_WITH_AES_256_CBC_SHA
- (0xC023) TLS_ECDHE_ECDSA_WITH_AES_128_CBC_SHA256 (D)
- (0xC024) TLS_ECDHE_ECDSA_WITH_AES_256_CBC_SHA384 (D)
- (0xC025) TLS_ECDH_ECDSA_WITH_AES_128_CBC_SHA256
- (0xC026) TLS_ECDH_ECDSA_WITH_AES_256_CBC_SHA384
- (0xC027) TLS_ECDHE_RSA_WITH_AES_128_CBC_SHA256 (D)
- (0xC028) TLS_ECDHE_RSA_WITH_AES_256_CBC_SHA384 (D)
- (0xC029) TLS_ECDH_RSA_WITH_AES_128_CBC_SHA256
- (0xC02A) TLS_ECDH_RSA_WITH_AES_256_CBC_SHA384
- (0xC02B) TLS_ECDHE_ECDSA_WITH_AES_128_GCM_SHA256 (D)
- (0xC02C) TLS_ECDHE_ECDSA_WITH_AES_256_GCM_SHA384 (D)
- (0xC02D) TLS_ECDH_ECDSA_WITH_AES_128_GCM_SHA256
- (0xC02E) TLS_ECDH_ECDSA_WITH_AES_256_GCM_SHA384
- (0xC02F) TLS_ECDHE_RSA_WITH_AES_128_GCM_SHA256 (D)
- (0xC030) TLS_ECDHE_RSA_WITH_AES_256_GCM_SHA384 (D)
- (0xC031) TLS_ECDH_RSA_WITH_AES_128_GCM_SHA256
- (0xC032) TLS_ECDH_RSA_WITH_AES_256_GCM_SHA384
- (0xC0AE) TLS_ECDHE_ECDSA_WITH_AES_128_CCM_8



When using an UDP socket, if <op_code>=1 (DTLS version) and <param_val>=0 (any version) the connection is allowed only to DTLS servers (version DTLS v1.2) which support the following default cipher suites:

- (0xC0A8) TLS_PSK_WITH_AES_128_CCM_8 (D)

SARA-R422M8S / SARA-R422S

The available cipher suites are presented in the following list:

- (0x000A) TLS_RSA_WITH_3DES_EDE_CBC_SHA
- (0x0013) TLS_DHE_DSS_WITH_3DES_EDE_CBC_SHA
- (0x0015) TLS_DHE_RSA_WITH_DES_CBC_SHA
- (0x0016) TLS_DHE_RSA_WITH_3DES_EDE_CBC_SHA
- (0x001A) TLS_DH_anon_WITH_DES_CBC_SHA

- (0x001B) TLS_DH_anon_WITH_3DES_EDE_CBC_SHA
- (0x002F) TLS_RSA_WITH_AES_128_CBC_SHA
- (0x0032) TLS_DHE_DSS_WITH_AES_128_CBC_SHA
- (0x0033) TLS_DHE_RSA_WITH_AES_128_CBC_SHA
- (0x0034) TLS_DH_anon_WITH_AES_128_CBC_SHA
- (0x0035) TLS_RSA_WITH_AES_256_CBC_SHA
- (0x0039) TLS_DHE_RSA_WITH_AES_256_CBC_SHA
- (0x003A) TLS_DH_anon_WITH_AES_256_CBC_SHA
- (0x003C) TLS_RSA_WITH_AES_128_CBC_SHA256
- (0x003D) TLS_RSA_WITH_AES_256_CBC_SHA256
- (0x0040) TLS_DHE_DSS_WITH_AES_128_CBC_SHA256 (D)
- (0x0067) TLS_DHE_RSA_WITH_AES_128_CBC_SHA256
- (0x006B) TLS_DHE_RSA_WITH_AES_256_CBC_SHA256
- (0x006C) TLS_DH_anon_WITH_AES_128_CBC_SHA256
- (0x006D) TLS_DH_anon_WITH_AES_256_CBC_SHA256
- (0x008B) TLS_PSK_WITH_3DES_EDE_CBC_SHA
- (0x008C) TLS_PSK_WITH_AES_128_CBC_SHA
- (0x008D) TLS_PSK_WITH_AES_256_CBC_SHA
- (0x008F) TLS_DHE_PSK_WITH_3DES_EDE_CBC_SHA
- (0x0090) TLS_DHE_PSK_WITH_AES_128_CBC_SHA
- (0x0091) TLS_DHE_PSK_WITH_AES_256_CBC_SHA
- (0x0093) TLS_RSA_PSK_WITH_3DES_EDE_CBC_SHA
- (0x0094) TLS_RSA_PSK_WITH_AES_128_CBC_SHA
- (0x0095) TLS_RSA_PSK_WITH_AES_256_CBC_SHA
- (0x009C) TLS_RSA_WITH_AES_128_GCM_SHA256 (D)
- (0x009D) TLS_RSA_WITH_AES_256_GCM_SHA384 (D)
- (0x009E) TLS_DHE_RSA_WITH_AES_128_GCM_SHA256 (D)
- (0x009F) TLS_DHE_RSA_WITH_AES_256_GCM_SHA384 (D)
- (0x00A8) TLS_PSK_WITH_AES_128_GCM_SHA256 (D)
- (0x00A9) TLS_PSK_WITH_AES_256_GCM_SHA384 (D)
- (0x00AA) TLS_DHE_PSK_WITH_AES_128_GCM_SHA256 (D)
- (0x00AB) TLS_DHE_PSK_WITH_AES_256_GCM_SHA384 (D)
- (0x00AC) TLS_RSA_PSK_WITH_AES_128_GCM_SHA256 (D)
- (0x00AD) TLS_RSA_PSK_WITH_AES_256_GCM_SHA384 (D)
- (0x00AE) TLS_PSK_WITH_AES_128_CBC_SHA256 (D)
- (0x00AF) TLS_PSK_WITH_AES_256_CBC_SHA384 (D)
- (0x00B2) TLS_DHE_PSK_WITH_AES_128_CBC_SHA256 (D)
- (0x00B3) TLS_DHE_PSK_WITH_AES_256_CBC_SHA384 (D)
- (0x00B6) TLS_RSA_PSK_WITH_AES_128_CBC_SHA256 (D)
- (0x00B7) TLS_RSA_PSK_WITH_AES_256_CBC_SHA384 (D)
- (0xC003) TLS_ECDH_ECDSA_WITH_3DES_EDE_CBC_SHA
- (0xC004) TLS_ECDH_ECDSA_WITH_AES_128_CBC_SHA
- (0xC005) TLS_ECDH_ECDSA_WITH_AES_256_CBC_SHA
- (0xC008) TLS_ECDHE_ECDSA_WITH_3DES_EDE_CBC_SHA
- (0xC009) TLS_ECDHE_ECDSA_WITH_AES_128_CBC_SHA
- (0xC00A) TLS_ECDHE_ECDSA_WITH_AES_256_CBC_SHA
- (0xC00D) TLS_ECDH_RSA_WITH_3DES_EDE_CBC_SHA
- (0xC00E) TLS_ECDH_RSA_WITH_AES_128_CBC_SHA
- (0xC00F) TLS_ECDH_RSA_WITH_AES_256_CBC_SHA
- (0xC012) TLS_ECDHE_RSA_WITH_3DES_EDE_CBC_SHA
- (0xC013) TLS_ECDHE_RSA_WITH_AES_128_CBC_SHA
- (0xC014) TLS_ECDHE_RSA_WITH_AES_256_CBC_SHA
- (0xC017) TLS_ECDH_anon_WITH_3DES_EDE_CBC_SHA

- (0xC018) TLS_ECDH_anon_WITH_AES_128_CBC_SHA
- (0xC019) TLS_ECDH_anon_WITH_AES_256_CBC_SHA
- (0xC023) TLS_ECDHE_ECDSA_WITH_AES_128_CBC_SHA256 (D)
- (0xC024) TLS_ECDHE_ECDSA_WITH_AES_256_CBC_SHA384
- (0xC025) TLS_ECDH_ECDSA_WITH_AES_128_CBC_SHA256
- (0xC026) TLS_ECDH_ECDSA_WITH_AES_256_CBC_SHA384
- (0xC027) TLS_ECDHE_RSA_WITH_AES_128_CBC_SHA256
- (0xC028) TLS_ECDHE_RSA_WITH_AES_256_CBC_SHA384
- (0xC029) TLS_ECDH_RSA_WITH_AES_128_CBC_SHA256
- (0xC02A) TLS_ECDH_RSA_WITH_AES_256_CBC_SHA384
- (0xC02B) TLS_ECDHE_ECDSA_WITH_AES_128_GCM_SHA256
- (0xC02C) TLS_ECDHE_ECDSA_WITH_AES_256_GCM_SHA384
- (0xC02D) TLS_ECDH_ECDSA_WITH_AES_128_GCM_SHA256
- (0xC02E) TLS_ECDH_ECDSA_WITH_AES_256_GCM_SHA384
- (0xC02F) TLS_ECDHE_RSA_WITH_AES_128_GCM_SHA256
- (0xC030) TLS_ECDHE_RSA_WITH_AES_256_GCM_SHA384
- (0xC031) TLS_ECDH_RSA_WITH_AES_128_GCM_SHA256
- (0xC032) TLS_ECDH_RSA_WITH_AES_256_GCM_SHA384
- (0xC034) TLS_ECDHE_PSK_WITH_3DES_EDE_CBC_SHA
- (0xC035) TLS_ECDHE_PSK_WITH_AES_128_CBC_SHA
- (0xC036) TLS_ECDHE_PSK_WITH_AES_256_CBC_SHA
- (0xC037) TLS_ECDHE_PSK_WITH_AES_128_CBC_SHA256 (D)
- (0xC038) TLS_ECDHE_PSK_WITH_AES_256_CBC_SHA384 (D)
- (0xC0A4) TLS_PSK_WITH_AES_128_CCM (D)
- (0xC0A5) TLS_PSK_WITH_AES_256_CCM (D)
- (0xC0A6) TLS_DHE_PSK_WITH_AES_128_CCM (D)
- (0xC0A7) TLS_DHE_PSK_WITH_AES_256_CCM (D)
- (0xC0A8) TLS_PSK_WITH_AES_128_CCM_8 (D)
- (0xC0A9) TLS_PSK_WITH_AES_256_CCM_8 (D)
- (0xC0AA) TLS_PSK_DHE_WITH_AES_128_CCM_8
- (0xC0AB) TLS_PSK_DHE_WITH_AES_256_CCM_8
- (0xC0AC) TLS_ECDHE_ECDSA_WITH_AES_128_CCM (D)
- (0xC0AD) TLS_ECDHE_ECDSA_WITH_AES_256_CCM (D)
- (0xC0AE) TLS_ECDHE_ECDSA_WITH_AES_128_CCM_8 (D)
- (0xC0AF) TLS_ECDHE_ECDSA_WITH_AES_256_CCM_8 (D)
- (0xCCA8) TLS_ECDHE_RSA_WITH_CHACHA20_POL1305_SHA256 (D)
- (0xCCA9) TLS_ECDHE_ECDSA_WITH_CHACHA20_POL1305_SHA256 (D)
- (0xCCAA) TLS_DHE_RSA_WITH_CHACHA20_POL1305_SHA256 (D)
- (0xCCAB) TLS_PSK_WITH_CHACHA20_POL1305_SHA256 (D)
- (0xCCAC) TLS_ECDHE_PSK_WITH_CHACHA20_POL1305_SHA256 (D)
- (0xCCAD) TLS_DHE_PSK_WITH_CHACHA20_POL1305_SHA256 (D)
- (0xCCAE) TLS_RSA_PSK_WITH_CHACHA20_POL1305_SHA256 (D)

21 FTP

Proprietary u-blox AT commands. FTP AT commands set can be used for sending and receiving files over the available bearer, transparently retrieving and storing them in the file system. Standard file and directory management operations on the remote FTP server are as well possible. PSD or CSD connection must be activated before using FTP client services.

- SARA-R404M**
No need to establish a PSD connection explicitly. This device automatically establishes a PSD connection as part of the network registration and attach procedure.
- SARA-R410M / SARA-R412M / SARA-R422M8S / SARA-R422S / SARA-N4**
See **+UPSD** AT command for CID mapping and **+CGACT** for activating a PDP context.

Basically, two AT commands are necessary for an FTP client service: one AT command (**+UFTP**) to configure the FTP profile, a second AT command to execute a specific FTP command (**+UFTPC**). The final result of an FTP command will be notified through the +UUFTPCR URC whereas data will be provided through +UUFTPCD URC.

When these commands report an error which is not a +CME ERROR, the error code can be queried using the **+UFTPER** AT command.

21.1 FTP service configuration +UFTP

| +UFTP | | | | | | |
|-------------------|---|---------------------|-----------------------|-----------------------|----------------------|----------------------------|
| Modules | SARA-R404M SARA-R410M SARA-R412M SARA-R422M8S SARA-R422S SARA-N4 | | | | | |
| Attributes | Syntax | PIN required | Settings saved | Can be aborted | Response time | Error reference |
| | partial | No | No | No | - | +CME Error |

21.1.1 Description

Sets up a parameter for FTP service, or resets a parameter to its factory-programmed value. The set/reset command needs to be executed for each single <op_code>. The read command returns the current setting of all the FTP parameters, one per line (i.e. the FTP profile). The FTP parameter values set with this command are all volatile (not stored in non-volatile memory).

- If the set command is issued without <param1> parameter, the corresponding <op_code> parameter is reset to the default value.

21.1.2 Syntax

| Type | Syntax | Response | Example |
|------------------------------|---|----------|----------------------------------|
| Generic syntax | | | |
| Set | AT+UFTP=<op_code>[,<param1>[,<param2>]] | OK | AT+UFTP=7,21 OK |
| FTP server IP address | | | |
| Set | AT+UFTP=0[,<IP_address>] | OK | AT+UFTP=0,"192.168.1.0" OK |
| FTP server name | | | |
| Set | AT+UFTP=1[,<server_name>] | OK | AT+UFTP=1,"ftp.server.com" OK |
| Username | | | |
| Set | AT+UFTP=2[,<username>] | OK | AT+UFTP=2,"user_test" OK |
| Password | | | |
| Set | AT+UFTP=3[,<password>] | OK | AT+UFTP=3,"PWD" OK |
| Account | | | |
| Set | AT+UFTP=4[,<account>] | OK | AT+UFTP=4,"test" |

| Type | Syntax | Response | Example |
|--|---|---|---|
| | | | OK |
| Inactivity timeout | | | |
| Set | AT+UFTP=5,<timeout>[,<linger_cmd>],[<linger_data>]] | OK | AT+UFTP=5,0,0,0 OK |
| FTP mode | | | |
| Set | AT+UFTP=6[,<FTP_mode>] | OK | AT+UFTP=6,1 OK |
| FTP server port | | | |
| Set | AT+UFTP=7[,<FTP_server_port>] | OK | AT+UFTP=7,30 OK |
| FTP control connection security | | | |
| Set | AT+UFTP=8[,<FTP_secure>[,<USECMNG_profile>]] | OK | AT+UFTP=8,1,2 OK |
| Timer trigger configuration for Direct Link | | | |
| Set | AT+UFTP=9,<timer_trigger> | OK | AT+UFTP=9,500 OK |
| Data length trigger configuration for Direct Link | | | |
| Set | AT+UFTP=10,<data_length_trigger> | OK | AT+UFTP=10,1024 OK |
| Character trigger configuration for Direct Link | | | |
| Set | AT+UFTP=11,<character_trigger> | OK | AT+UFTP=11,13 OK |
| FTP data connection security | | | |
| Set | AT+UFTP=12[,<FTP_secure>[,<USECMNG_profile>]] | OK | AT+UFTP=12,1,2 OK |
| Read | AT+UFTP=? | +UFTP: 0,<IP_address> +UFTP: 1,<server_name> +UFTP: 2,<username> +UFTP: 4,<account> +UFTP: 5,<timeout>,<linger_cmd>,<linger_data> +UFTP: 6,<FTP_mode> +UFTP: 7,<FTP_server_port> +UFTP: 8,<FTP_secure>[,<USECMNG_profile>] +UFTP: 9,<timer_trigger> +UFTP: 10,<data_length_trigger> +UFTP: 11,<character_trigger> +UFTP: 12,<FTP_secure>[,<USECMNG_profile>] OK | +UFTP: 0,"216.239.59.147" +UFTP: 1,"" +UFTP: 2,"username" +UFTP: 4,"account" +UFTP: 5,0,0,0 +UFTP: 6,0 +UFTP: 7,21 +UFTP: 8,0 +UFTP: 9,500 +UFTP: 10,1024 +UFTP: 11,13 +UFTP: 12,0 OK |
| Test | AT+UFTP=? | +UFTP: (list of supported <param_tag>s) OK | +UFTP: (0-11) OK |

21.1.3 Defined values

| Parameter | Type | Description |
|-----------|--------|---|
| <op_code> | String | FTP parameter: <ul style="list-style-type: none"> 0: FTP server IP address 1: FTP server name |

| Parameter | Type | Description |
|-----------------------|-----------------|--|
| | | <ul style="list-style-type: none"> • 2: FTP username • 3: FTP password • 4: FTP additional user account • 5: FTP inactivity timeout period and linger time • 6: FTP mode • 7: remote FTP server listening port • 8: control connection security • 9: timer trigger • 10: data length trigger • 11: character trigger • 12: data connection security Allowed values: <ul style="list-style-type: none"> • SARA-R422M8S / SARA-R422S - 0, 1, 2, 3, 4, 5, 6, 7, 8, 12 • SARA-R410M-63B / SARA-R410M-73B / SARA-R410M-83B - 0, 1, 2, 3, 4, 5, 6, 7, 8, 9. <op_code>=9 is used for FTP data connection security instead of <op_code>=12. • SARA-R410M-02B / SARA-R410M-52B / SARA-R412M / SARA-N4 - 0, 1, 2, 3, 4, 5, 6, 7, 8 • SARA-R404M / SARA-R410M-01B - 0, 1, 2, 3, 4, 5, 6, 7 |
| <IP_address> | String | FTP server IP address. The default value is an empty string. For IP address format reference see the IP addressing . |
| <server_name> | String | FTP server name (e.g. "ftp.server.com"). The maximum length is 128 characters. The default value is an empty string. |
| <username> | String | User name (the maximum length is 30 characters) for the FTP login procedure. The default value is an empty string. |
| <password> | String | Password (the maximum length is 30 characters) for the FTP login procedure. The default value is an empty string. |
| <account> | String | Additional user account (if required) for the FTP login procedure. The maximum length is 30 characters. The default value is an empty string. |
| <timeout> | Number | Inactivity timeout period in seconds. The range goes from 0 to 86400 s; 0 means no timeout (the FTP session will not be terminated in the absence of incoming traffic). The default value is 30 s. |
| <linger_cmd> | Number | Linger time for command socket in seconds. The range goes from 0 to 120 s; 0 means linger time is not set. The default value is 60 s. |
| <linger_data> | Number | Linger time for data socket in seconds. The range goes from 0 to 120 s; 0 means linger time is not set. The default value is 60 s. |
| <FTP_mode> | Number | FTP mode: <ul style="list-style-type: none"> • 0 (default value): active • 1: passive |
| <FTP_server_port> | Number | Remote FTP server listening port; it must be a valid TCP port value. The range goes from 1 to 65535; the default value is 21. |
| <FTP_secure> | Number | Enables / disables the secure option of FTP client service: <ul style="list-style-type: none"> • 0 (default value): no SSL encryption • 1: enable SSL encryption of FTP (control connection or data connection). Only the explicit FTPS mode is supported. |
| <USECMNG_profile> | Number | USECMNG profile (number). Defines the USECMNG profile which specifies the SSL/TLS properties to be used for the SSL/TLS connection. The range goes from 0 to 4. If no profile is set a default USECMNG profile is used (see USECMNG section). |
| <timer_trigger> | Number | Enhanced direct link sending timer trigger (in milliseconds); valid range is 0 (factory-programmed value), 100-120000; 0 means trigger disabled. |
| <data_length_trigger> | Number | Enhanced direct link data length trigger in bytes, valid range is 0 (factory-programmed value), 3-2048; 0 means trigger disabled. |
| <character_trigger> | Number | Enhanced direct link character trigger, the value represents the ASCII code (in base 10) of the character to be used as character trigger. The allowed range is -1, 0-255, the factory-programmed value is -1; -1 means trigger disabled. |
| <param1> | Number / String | Type and supported content depend on related <op_code> (details are given above). If <param1> is not specified the value of the corresponding parameter <op_code> is reset to default value. |
| <param2> | Number / String | Type and supported content depend on related <op_code> (details are given above). If <param2> is not specified the value of the corresponding parameter <op_code> is reset to default value. |

21.1.4 Notes

- The information text response to the read command does not display the password.
- The FTP server IP address and the FTP server name are mutually exclusive. If value for <op_code>=0 is specified by user, then value for <op_code>=1 is reset or vice versa.
- Some network operators do not allow incoming connections. Due to these limitations introduced by network operators it is possible to encounter problems using FTP active mode. If the FTP active mode fails to exchange files, try the passive mode to solve the problem.
- Some network operators do not allow FTPS. In this case the **AT+UFTPC=1** command (FTP login) will return a failure response via **+UUFTPCR** URC after an SSL timeout of 30 s.

SARA-R422M8S / SARA-R422S

- <timer_trigger>, <data_length_trigger> and <character_trigger> parameters are not supported.
- Enable the control connection security (<op_code>=8), before enabling the data connection security (<op_code>=12).

SARA-R404M / SARA-R410M / SARA-R412M / SARA-N4



- <timer_trigger>, <data_length_trigger> and <character_trigger> parameters are not supported.
- <linger_cmd> and <linger_data> parameters are not supported.
- During connection to FTP remote server (via FTP login command) the FTP profile parameters cannot be changed or reset to factory-programmed values until disconnection takes place (FTP logout). Only <op_code>=5 (inactivity timeout), and <op_code>=6 (FTP mode), can be updated while the FTP connection is on the go.

21.2 FTP command +UFTPC

| +UFTPC | | | | | | |
|-------------------|---|---------------------|-----------------------|-----------------------|----------------------|------------------------|
| Modules | SARA-R404M SARA-R410M SARA-R412M SARA-R422M8S SARA-R422S SARA-N4 | | | | | |
| Attributes | Syntax | PIN required | Settings saved | Can be aborted | Response time | Error reference |
| | partial | No | No | No | - | +CME Error |

21.2.1 Description

Triggers the FTP actions corresponding to the <op_code> parameter. The final result code indicates if sending the command request to the FTP process was successful or not. The +UUFTPCR (FTP command result) URC returns to the user the final result of the FTP command previously sent with **+UFTPC**. As well, the +UUFTPCD FTP unsolicited data URC provides the data requested by the user (e.g. file or directory lists) and received from the FTP server.

-  SARA-R422M8S / SARA-R422S
The +UUFTPCD URC is displayed only on the AT terminal that issued the +UFTPC related command.
-  The timing before the +UUFTPCR URC is issued on the AT terminal also depends by the DNS resolution. For further details about the estimated response time related to the DNS resolution, see the **+UDNSRN** AT command.
-  SARA-R404M / SARA-R410M / SARA-R412M / SARA-N4
When using direct link mode to retrieve a file from the FTP server (<op_code>=6) or to send a file to the FTP server (<op_code>=7), if the HW flow control is disabled (**AT+IFC**), a data loss could be experienced. So the HW flow control usage is strongly recommended.

21.2.2 Syntax

| Type | Syntax | Response | Example |
|-----------------------|---|----------|--|
| General syntax | | | |
| Set | AT+UFTPC=<op_code>[,<param1>[,<param2>[,<param3>]]] | OK | AT+UFTPC=4,"data.zip","data.zip" OK |
| FTP logout | | | |
| Set | AT+UFTPC=0 | OK | AT+UFTPC=0 OK |

| Type | Syntax | Response | Example |
|---|---|---|---|
| FTP login | | | |
| Set | AT+UFTPC=1 | OK | AT+UFTPC=1 OK |
| Delete the file from the FTP server | | | |
| Set | AT+UFTPC=2,<filename> | OK | AT+UFTPC=2,"mytest" OK |
| Rename a file of FTP server | | | |
| Set | AT+UFTPC=3,<filename>,<new_filename> | OK | AT+UFTPC=3,"old_name","final_name" OK |
| Retrieve the file from the FTP server | | | |
| Set | AT+UFTPC=4,<remote_filename>,<local_filename>[,<retrieving_mode>] | OK | AT+UFTPC=4,"data.zip","data.zip" OK |
| Store the file on the FTP server | | | |
| Set | AT+UFTPC=5,<local_filename>,<remote_filename>[,<number_of_byte>] | OK | AT+UFTPC=5,"data.zip","data.zip",30 OK |
| Retrieve a file from the FTP server using direct link mode | | | |
| Set | AT+UFTPC=6,<remote_filename>[,<number_of_byte>] | OK | AT+UFTPC=6,"data.zip",30 OK |
| Send a file to the FTP server using the direct link mode | | | |
| Set | AT+UFTPC=7,<remote_filename>[,<number_of_byte>] | OK | AT+UFTPC=7,"data.zip",30 OK |
| Change the working directory to the specified one | | | |
| Set | AT+UFTPC=8,<directory_name> | OK | AT+UFTPC=8,"data_folder" OK |
| Create a directory on the FTP host | | | |
| Set | AT+UFTPC=10,<directory_name> | OK | AT+UFTPC=10,"new_data_folder" OK |
| Remove the directory from the remote FTP server | | | |
| Set | AT+UFTPC=11,<directory_name> | OK | AT+UFTPC=11,"data_folder" OK |
| Information of a file or a directory | | | |
| Set | AT+UFTPC=13[,<file_directory_name>] | OK | AT+UFTPC=13,"data_folder" OK |
| List the filenames in a specified directory | | | |
| Set | AT+UFTPC=14[,<file_directory_name>] | OK | AT+UFTPC=14,"data.zip" OK |
| Retrieve the FOTA update file | | | |
| Set | AT+UFTPC=100,<remote_filename>[,<fw_download_status>] | OK | AT+UFTPC=100,"data.zip" OK |
| URC | | +UUFTPCR: 100,<stored_byte> / <total_byte> | +UUFTPCR: 100,202752 / 1103692 |
| Test | AT+UFTPC=? | +UFTPC: (list of supported <op_code>s) OK | +UFTPC: (0-5,8,10,11,13,14,100) OK |
| URC | | +UUFTPCD: <op_code>,<ftp_data_len>,<ftp_data> | +UUFTPCD: 13,16,"16 bytes of data" |
| URC | | +UUFTPCR: <op_code>,<ftp_result>[,<md5_sum>] | +UUFTPCR: 1,1 |

21.2.3 Defined values

| Parameter | Type | Description |
|-----------------------|--------|---|
| <op_code> | Number | <p>FTP command request. Allowed values:</p> <ul style="list-style-type: none"> 0: FTP logout; terminates the FTP session by performing a logout. 1: FTP login; connects to the FTP server using the parameters of the current FTP profile (set via AT+UFTP command). 2: deletes the file from the FTP server. 3: renames the file. This AT command just sends requests to the FTP process. 4: retrieves the file from the FTP server. 5: stores the file on the FTP server. 6: retrieves a file from the FTP server using direct link mode. This command handles the initial steps of the FTP protocol for retrieving a file; after that it will establish a transparent end-to-end communication with the data connection TCP socket via the serial interface. After the CONNECT result code, the file content will be directly sent to the serial interface. When the data transfer is completed, the module will automatically exit from direct link mode (no need to send +++ sequence). 7: sends a file to the FTP server using the direct link mode. This command handles the initial steps of the FTP protocol for sending a file; after that it will establish a transparent end-to-end communication with the data connection TCP socket via the serial interface. After the CONNECT result code, the user can send the file content via the serial interface. Once finished, the user must wait at least 2 s before sending the +++ sequence to switch off the direct link mode. This operation may take a few seconds because the command also handles the final steps of the FTP protocol. 8: changes the working directory to the specified one. 9: RFU. 10: creates a directory on the FTP host. 11: removes the directory from the remote FTP server. 12: RFU. 13: information of a file or a directory. The URC +UUFTPCD returns the information of the specified file or directory from the FTP server. 14: lists the filenames in a specified directory. The URC +UUFTPCD returns the list of the filenames received from FTP server. If the directory name is omitted, the list of the files names of current working directory is requested. 100: retrieves the FOTA update file. The downloaded file will not be accessible to the user. During the download of the FOTA update file the +UUFTPCR: 100,<stored_byte> / <total_byte> URC (where supported) will provide the status of the download. At the end of the download file the +UUFTPCR: 100,<ftp_result>[,<md5_sum>] URC will provide the operation result. The <md5_sum> parameter will display the MD5 checksum of the downloaded file. |
| <filename> | String | Filename to be deleted/renamed from the FTP host. For the limit of the length of the string, see Command line . |
| <new_filename> | String | New filename. For the limit of the length of the string, see Command line . |
| <remote_filename> | String | Remote filename to be retrieved from the FTP host or stored in it. The maximum parameter length is 256 characters. |
| <local_filename> | String | Local filename (module file system) text string to be stored/sent on the file system. For the limit of the length of the string, see the File system limits . |
| <retrieving_mode> | Number | <p>Allowed values:</p> <ul style="list-style-type: none"> 0 (default value): the file is retrieved from beginning. 1: restart the data retrieving from the last data received during the previous download interrupted due to error. |
| <number_of_byte> | Number | <p>Represents the number of bytes already sent to the FTP server or received from it.</p> <ul style="list-style-type: none"> During a file retrieval the server writes the file from the offset indicated with this parameter. During a file storing the server sends the data from the value indicated with this parameter. |
| <directory_name> | String | Directory name on the FTP server. For the limit of the length of the string, see Command line . |
| <file_directory_name> | String | Path file/directory name to be listed. If not specified, the current directory list is requested. For the limit of the length of the string, see Command line . |

| Parameter | Type | Description |
|----------------------|--------|---|
| | | <ul style="list-style-type: none"> <param1> optional parameter; the text string of the path (file or directory) to be name listed. If not specified, the list of the files names of current working directory is requested. |
| <fw_download_status> | Number | Manages the firmware package download status: <ul style="list-style-type: none"> if omitted trigger the firmware package download from an FTP server 0: cancel the firmware package download from an FTP server 1: resume the firmware package download from an FTP server |
| <ftp_data_len> | Number | Amount of data in bytes |
| <ftp_data> | String | Data available from the FTP server in the ASCII [0x00,0xFF] range. The starting quotation mark shall not be taken into account like data, the first byte of data starts after the first quotation mark. The total number of bytes is <ftp_data_len>. At the end of the byte stream, another quotation mark is provided for user convenience and visualization purposes. |
| <ftp_result> | Number | Allowed values: <ul style="list-style-type: none"> 0: fail 1: success |
| <md5_sum> | String | MD5 checksum of the FOTA update file downloaded via +UFTPC=100 AT command. This parameter is issued only for +UFTPC=100 AT command. |
| <stored_byte> | Number | Amount of stored bytes |
| <total_byte> | Number | Amount of total bytes of the FOTA update file to be stored |
| <param1> | String | Content depend on related <op_code> (details are given above) |
| <param2> | String | Content depend on related <op_code> (details are given above) |
| <param3> | String | Content depend on related <op_code> (details are given above) |

21.2.4 Notes

- If <op_code>=6 the user must switch off the direct link mode (sending +++ to the serial interface) when the data stream is finished. This operation may take up to 10 s because the command also handles the final steps of the FTP protocol.

SARA-R422M8S / SARA-R422S

- The+UUFTPCR: 100,<stored_byte> / <total_byte> URC is not supported.
- The time to establish the secure session (when using +UFTFP: 8,1[,<USECMNG_profile>] or +UFTFP: 12,1[,<USECMNG_profile>]) could require up to 150 s in one of these cases:
 - RoT generated PSK (+USECPRF: <profile_id>,11)
 - encrypted session resumption (+USECPRF: <profile_id>,13,2,10)

This is due to "security heartbeat" message operation. For more details on when this scenario occurs, see the +USECCONN AT command.

SARA-R404M / SARA-R410M / SARA-R412M / SARA-N4

- The <md5_sum> parameter is not supported.
- If <op_code>=100 (retrieves the FOTA update file), the <remote_filename> parameter cannot include the file path and its maximum length is 64 characters.

21.3 FTP error +UFTPER

| +UFTPER | | | | | | |
|-------------------|---|---------------------|-----------------------|-----------------------|----------------------|------------------------------|
| Modules | SARA-R404M SARA-R410M SARA-R412M SARA-R422M8S SARA-R422S SARA-N4 | | | | | |
| Attributes | Syntax | PIN required | Settings saved | Can be aborted | Response time | Error reference |
| | full | No | No | No | - | +CME Error Appendix A.7.1 |

21.3.1 Description

This command retrieves the error class and code of the last FTP operation.

21.3.2 Syntax



| Type | Syntax | Response | Example |
|--------|-----------|---|--------------------|
| Action | AT+UFTPER | +UFTPER: <error_class>,<error_code> OK | +UFTPER: 1,1 OK |

21.3.3 Defined values

| Parameter | Type | Description |
|---------------|--------|--|
| <error_class> | Number | Value of error class. Values are listed in Appendix A.7 . |
| <error_code> | Number | Value of class-specific error code (reply code if <error_class> is 0). The values are listed in Appendix A.7.1 . |

22 HTTP

The section describes the u-blox proprietary AT commands that can be used for sending requests to a remote HTTP server, receiving the server response and transparently storing it in the file system. The supported methods are: HEAD, GET, DELETE, PUT, POST file and POST data. A PSD or CSD connection must be activated before using HTTP AT commands.

-  **SARA-R404M**
No need to establish a PSD connection explicitly. This device automatically establishes a PSD connection as part of the network registration and attach procedure.
-  **SARA-R410M / SARA-R412M / SARA-R422M8S / SARA-R422S / SARA-N4**
See **+UPSD** for CID mapping and **+CGACT** for activating a PDP context.



When these commands report an HTTP error, the error code can be queried using the **+UHTTPER** AT command.

22.1 HTTP control +UHTTP

| +UHTTP | | | | | | |
|-------------------|---|---------------------|-----------------------|-----------------------|----------------------|----------------------------|
| Modules | SARA-R404M SARA-R410M SARA-R412M SARA-R422M8S SARA-R422S SARA-N4 | | | | | |
| Attributes | Syntax | PIN required | Settings saved | Can be aborted | Response time | Error reference |
| | partial | No | No | No | - | +CME Error |

22.1.1 Description

Configures, reads or resets (to the factory-programmed values) the HTTP application profile parameters. Up to 4 different HTTP profiles can be defined. To set all the parameters in an HTTP profile a set command for each `<op_code>` needs to be issued.

-  The configured HTTP profile parameters are not saved in the non volatile memory.
-  The read command has two possible usages. The functionality of the command differs with the number of command parameters issued:
 - Only the first command parameter (`<profile_id>`) issued: the module resets all the profile parameters (to the factory-programmed values) for the profile specified with `<profile_id>`
 - Only the first and second command parameters used (`<profile_id>`, `<op_code>`): the module returns the current value of the profile parameter specified with `<op_code>` and related to the profile specified with `<profile_id>`

22.1.2 Syntax

| Type | Syntax | Response | Example |
|-------------------------------|--|---|---|
| Generic syntax | | | |
| Set | AT+UHTTP=<profile_id>,<op_code>,<param_val>[,<param_val1>] | OK | AT+UHTTP=2,0,"125.24.51.133" OK |
| Read | AT+UHTTP=<profile_id>,<op_code> | +UHTTP: <profile_id>,<op_code>,<param_val>[,<param_val1>] OK | AT+UHTTP=2,0 +UHTTP: 2,0,"125.24.51.133" OK |
| HTTP server IP address | | | |
| Set | AT+UHTTP=<profile_id>,0,<HTTP_server_IP_address> | OK | AT+UHTTP=2,0,"125.24.51.133" OK |
| Read | AT+UHTTP=<profile_id>,0 | +UHTTP: <profile_id>,0,<HTTP_server_IP_address> OK | AT+UHTTP=2,0 +UHTTP: 2,0,"125.24.51.133" OK |
| HTTP server name | | | |
| Set | AT+UHTTP=<profile_id>,1,<HTTP_server_name> | OK | AT+UHTTP=2,1,"www.u-blox.com" OK |

| Type | Syntax | Response | Example |
|---|---|--|--|
| Read | AT+UHTTP=<profile_id>,1 | +UHTTP: <profile_id>,1,<HTTP_server_name> OK | AT+UHTTP=2,1 +UHTTP: 2,1,"www.u-blox.com" OK |
| Username | | | |
| Set | AT+UHTTP=<profile_id>,2,<username> | OK | AT+UHTTP=2,2,"my_user" OK |
| Read | AT+UHTTP=<profile_id>,2 | +UHTTP: <profile_id>,2,<username> OK | AT+UHTTP=2,2 +UHTTP: 2,2,"my_user" OK |
| Password | | | |
| Set | AT+UHTTP=<profile_id>,3,<password> | OK | AT+UHTTP=2,3,"pwd" OK |
| Read | AT+UHTTP=<profile_id>,3 | +UHTTP: <profile_id>,3,<password> OK | AT+UHTTP=2,3 +UHTTP: 2,3,"pwd" OK |
| Authentication type | | | |
| Set | AT+UHTTP=<profile_id>,4,<HTTP_authentication> | OK | AT+UHTTP=2,4,1 OK |
| Read | AT+UHTTP=<profile_id>,4 | +UHTTP: <profile_id>,4,<HTTP_authentication> OK | AT+UHTTP=2,4 +UHTTP: 2,4,1 OK |
| HTTP server port | | | |
| Set | AT+UHTTP=<profile_id>,5,<HTTP_port> | OK | AT+UHTTP=2,5,30 OK |
| Read | AT+UHTTP=<profile_id>,5 | +UHTTP: <profile_id>,5,<HTTP_port> OK | AT+UHTTP=2,5 +UHTTP: 2,5,30 OK |
| HTTP secure option | | | |
| Set | AT+UHTTP=<profile_id>,6,<HTTP_secure>[,<USECMNG_profile>] | OK | AT+UHTTP=2,6,1 OK |
| Read | AT+UHTTP=<profile_id>,6 | +UHTTP: <profile_id>,6,<HTTP_secure>[,<USECMNG_profile>] OK | AT+UHTTP=2,6 +UHTTP: 2,6,1 OK |
| HTTP request timeout and TCP socket linger timer | | | |
| Set | AT+UHTTP=<profile_id>,7,<HTTP_timeout>[,<linger_timer>] | OK | AT+UHTTP=2,7,150,5 OK |
| Read | AT+UHTTP=<profile_id>,7 | +UHTTP: <profile_id>,7,<HTTP_timeout>,<linger_timer> OK | AT+UHTTP=2,7 +UHTTP: 2,7,150,5 OK |
| HTTP add custom request headers | | | |
| Set | AT+UHTTP=<profile_id>,9,<custom_request_header> | OK | AT+UHTTP=2,9,"0:hdr0:val0" OK |
| Read | AT+UHTTP=<profile_id>,9 | +UHTTP: <profile_id>,9,<custom_request_header> OK | AT+UHTTP=2,9 +UHTTP: 2,9,"0:hdr0:val0" OK |
| Read | AT+UHTTP=<profile_id> | OK | AT+UHTTP=2 OK |
| Test | AT+UHTTP=? | +UHTTP: (list of supported <profile_id>s),(list of supported <op_code>s) OK | +UHTTP: (0-3),(0-9) OK |

| Type | Syntax | Response | Example |
|------|--------|----------|---------|
| | | OK | |

22.1.3 Defined values

| Parameter | Type | Description |
|--------------------------|--------|--|
| <profile_id> | Number | HTTP profile identifier, in range 0-3 |
| <op_code> | Number | Allowed values: <ul style="list-style-type: none"> • 0: HTTP server IP address; • 1: HTTP server name; • 2: username • 3: password • 4: authentication type • 5: HTTP server port • 6: HTTP Secure option (SSL encryption) • 7: HTTP request timeout and TCP socket linger timer • 8: reserved for internal use only • 9: HTTP add custom request headers |
| <HTTP_server_IP_address> | String | HTTP server IP address; The factory-programmed value is an empty text string. For IP address format reference see the IP addressing . |
| <HTTP_server_name> | String | HTTP server name (e.g. "http.server.com"). The factory-programmed value is an empty text string. The maximum length is: <ul style="list-style-type: none"> • SARA-R404M / SARA-R410M / SARA-R412M / SARA-N4 - 128 characters • SARA-R422M8S / SARA-R422S - 1024 characters |
| <username> | String | User name; the maximum length is 30 characters; it is used for the HTTP login procedure if the authentication is used. The factory-programmed value is an empty text string. |
| <password> | String | Password; the maximum length is 30 characters; it is used for the HTTP login procedure if the authentication is used. The factory-programmed value is an empty text string. |
| <HTTP_authentication> | Number | HTTP authentication method; the allowed values are: <ul style="list-style-type: none"> • 0 (factory-programmed value): no authentication • 1: basic authentication (the password and username must be set) |
| <HTTP_port> | Number | HTTP server port; range 1-65535. It means the HTTP server port to be used in a HTTP request; the factory-programmed value is 80. |
| <HTTP_secure> | Number | HTTP Secure option (SSL encryption). It enables or disables the HTTPS (SSL secured connection for HTTP application) usage: <ul style="list-style-type: none"> • 0 (factory-programmed value): HTTPS (SSL encryption) disabled and the HTTP server port set to 80 • 1: HTTPS (SSL encryption) enabled and the HTTP server port set to 443; an USECMNG profile can be specified with an additional parameter. |
| <USECMNG_profile> | Number | Defines the USECMNG profile which specifies the SSL/TLS properties to be used for the SSL/TLS connection. The range goes from 0 to 4. If no profile is set a default USECMNG profile is used |
| <HTTP_timeout> | Number | HTTP request timeout in seconds (number); the range is 30 - 180. It is the timeout in seconds to be used for all the HTTP requests with the specified profile. The factory-programmed value is 180 s. |
| <linger_timer> | Number | TCP linger timer for socket close expressed in seconds (number). <ul style="list-style-type: none"> • SARA-R422M8S / SARA-R422S - The range is 0 - 120 s, the default value is 30 s. With 0 value the linger option is disabled. • SARA-R410M / SARA-R412M - The range is 1 - 30 s, the default value is 3 s. |
| <custom_request_header> | String | Sets/clears the custom request header (string); the custom header option follows a defined format "hdr_id:hdr_name:hdr_value"; the hdr_id is a number in the range [0-4]; the hdr_name and hdr_value are strings having a maximum length of 256 characters (see examples below). <ul style="list-style-type: none"> • "0:hdr0:val0": set header 0 with name hdr0 and value val0 • "0:": clear header 0 • "1:hdr1:val1": set header 1 with name hdr1 and value val1 • "1:": clear header 1 • "2:hdr2:val2": set header 2 with name hdr2 and value val2 • "2:": clear header 2 |

| Parameter | Type | Description |
|--------------|-----------------|--|
| | | <ul style="list-style-type: none"> "3:hdr3:val3": set header 3 with name hdr3 and value val3 "3:": clear header 3 "4:hdr4:val4": set header 4 with name hdr4 and value val4 "4:": clear header 4 The following character is not allowed in the <custom_request_header> parameter: <ul style="list-style-type: none"> 0x3A (:) |
| <param_val> | Number / String | Type and supported content depend on the related <op_code> parameter; details are given above |
| <param_val1> | Number / String | Type and supported content depend on the related <op_code> parameter; details are given above. |

22.1.4 Notes

- HTTP server IP address and HTTP server name are mutually exclusive. If the HTTP server IP address is specified by the user, then the value for the HTTP server name is reset, or vice versa.

SARA-R422M8S / SARA-R422S

- The read command for <op_code>=9 (HTTP add custom request headers) is not supported.
- If the **+UPSD** command sets the PSD profile protocol type to IPv6, an IPv6 address shall be used for parameter HTTP server IP address.

SARA-R404M / SARA-R410M / SARA-R412M

- Set the secure option (<op_code>=6) before configuring the custom HTTP header with <op_code>=9 to ensure the proper default port number is used in the header.
- In custom HTTP header, configured with <op_code>=9, the hdr_name and hdr_value are strings having a maximum length of 64 characters.

SARA-R410M-63B / SARA-R410M-73B / SARA-R410M-83B

- On SARA-R410M-63B-00, SARA-R410M-73B-00, SARA-R410M-83B-00 the <linger_timer> parameter is not supported.

SARA-R410M-02B / SARA-R412M

- On SARA-R410M-02B-00, SARA-R410M-02B-01, SARA-R410M-02B-02, SARA-R412M-02B-00, SARA-R412M-02B-01, SARA-R412M-02B-02 the <linger_timer> parameter is not supported.

SARA-R410M-52B

- The <linger_timer> parameter is not supported.

SARA-R404M / SARA-R410M-01B

- <op_code>=6 (HTTP Secure option), 9 (HTTP add custom request headers) are not supported.
- The <linger_timer> parameter is not supported.

SARA-N4

- Set the secure option (<op_code>=6) before configuring the custom HTTP header with <op_code>=9 to ensure the proper default port number is used in the header.
- In custom HTTP header, configured with <op_code>=9, the hdr_name and hdr_value are strings having a maximum length of 64 characters.
- The <linger_timer> parameter is not supported.

22.2 HTTP advanced control+UHTTPAC

| +UHTTPAC | | | | | | |
|-------------------|---|---------------------|-----------------------|-----------------------|----------------------|----------------------------|
| Modules | SARA-R404M SARA-R410M SARA-R412M SARA-R422M8S SARA-R422S SARA-N4 | | | | | |
| Attributes | Syntax | PIN required | Settings saved | Can be aborted | Response time | Error reference |
| | full | No | No | No | - | +CME Error |

22.2.1 Description

Configures, reads or resets (to the factory-programmed values) the HTTP application profile advanced parameters.

The configured HTTP profile advanced parameters are not saved in the non volatile memory.

22.2.2 Syntax

| Type | Syntax | Response | Example |
|------|--|--|---|
| Set | AT+UHTTTPAC=<profile_id>,<param_tag>,<key>,<value> | OK | AT+UHTTTPAC=0,0,0,"UBLX_SESSION_COOKIE_0" OK |
| Read | AT+UHTTTPAC=<profile_id>,<param_tag>,<key> | +UHTTTPAC: <profile_id>,<param_tag>,<key>,<value> OK | AT+UHTTTPAC=0,0,0 +UHTTTPAC: 0,0,0,"UBLX_SESSION_COOKIE_0" OK |
| Test | AT+UHTTTPAC=? | +UHTTTPAC: (list of supported <profile_id>s),(list of supported <param_tag>s),(list of supported <key>s) OK | +UHTTTPAC: (0-3),(0),(0-3) OK |

22.2.3 Defined values

| Parameter | Type | Description |
|--------------|-------------------|---|
| <profile_id> | Number | HTTP profile identifier, in range 0-3 |
| <param_tag> | Number | <ul style="list-style-type: none"> • 0: HTTP request COOKIES; manage request COOKIES sent to the HTTP server. <ul style="list-style-type: none"> o <key>: index of the cookie (number); range 0-3. Identifies the cookie to be read if <value> is omitted or configured if <value> is a valid string. o <value>: value of the cookie (string); the maximum length is 256 characters. The cookie values respect the following rules: <ul style="list-style-type: none"> - Empty string (""): the cookie will be cleared and will not be present in the request; - Simple one-value cookie: the cookie will be set and sent in the request; - Complex multi-value cookie: the cookies will be set and sent in the request. The multiple cookies must be separated by a left-attached semicolon(";") and a space(" "); |
| <key> | Number/ String | Content depends on the related <param_tag> (see above). |
| <value> | Number/ String | Content depends on the related <param_tag> (see above). |

22.2.4 Examples and use cases

In this section some +UHTTTPAC AT command examples and use cases are listed.

| Command | Response | Description |
|--|----------|---|
| Example 1 AT+UHTTTPAC=0,0,0,"" | OK | Clear the HTTP request cookie at index 0. |
| Example 2 AT+UHTTTPAC=0,0,0,"SIMPLE_COOKIE" | OK | Set a simple HTTP request cookie at index 0. |
| Example 3 AT+UHTTTPAC=0,0,0,"COMPLEX_COOKIE; COMPLEX_COOKIE" | OK | Overwrite the HTTP request cookie at index 0 with a complex cookie. |

22.3 HTTP command +UHTTPC

| +UHTTPC | | | | | | |
|-------------------|---|---------------------|-----------------------|-----------------------|----------------------|------------------------|
| Modules | SARA-R404M SARA-R410M SARA-R412M SARA-R422M8S SARA-R422S SARA-N4 | | | | | |
| Attributes | Syntax | PIN required | Settings saved | Can be aborted | Response time | Error reference |
| | partial | No | No | No | - | +CME Error |

22.3.1 Description

Triggers the HTTP command specified with `<http_command>` parameter, using the HTTP application profile parameters (previously set up by `+UHTTTP` AT command), specified with `<profile_id>`. The response indicates if sending the command request to HTTP process was successful or not. The final result of HTTP command will be returned to the user via the `+UUHTTPCR` URC.



The timing before the `+UUHTTPCR` URC is issued on the AT terminal also depends by the DNS resolution. For further details about the estimated response time related to the DNS resolution, see the `+UDNSRN` AT command.

22.3.2 Syntax

| Type | Syntax | Response | Example |
|-----------------------------|--|--|---|
| Generic syntax | | | |
| Set | AT+UHTTPC=<profile_id>,<http_command>,<path>,<filename>[,<param1>[,<param2>[,<param3>]]] | OK | AT+UHTTPC=0,1,"/path/file.html", "responseFilename" OK |
| HEAD command | | | |
| Set | AT+UHTTPC=<profile_id>,0,<path>,<filename> | OK | AT+UHTTPC=0,0,"/path/file.html", "responseFilename" OK |
| GET command | | | |
| Set | AT+UHTTPC=<profile_id>,1,<path>,<filename> | OK | AT+UHTTPC=0,1,"/path/file.html", "responseFilename" OK |
| DELETE command | | | |
| Set | AT+UHTTPC=<profile_id>,2,<path>,<filename> | OK | AT+UHTTPC=0,2,"/path/file.html", "responseFilename" OK |
| PUT command | | | |
| Set | AT+UHTTPC=<profile_id>,3,<path>,<filename>,<filesystem_name>[,<HTTP_content_type>[,<user_defined_content_type>]] | OK | AT+UHTTPC=0,3,"/path/ file.html","responseFilename", "filesystemName" OK |
| POST file command | | | |
| Set | AT+UHTTPC=<profile_id>,4,<path>,<filename>,<filesystem_name>,<HTTP_content_type>[,<user_defined_content_type>] | OK | AT+UHTTPC=0,4,"/path/ file.html","responseFilename", "filesystemName",0 OK |
| POST data command | | | |
| Set | AT+UHTTPC=<profile_id>,5,<path>,<filename>,<data>,<HTTP_content_type>[,<user_defined_content_type>] | OK | AT+UHTTPC=0,5,"/path/file.html", "responseFilename","data",0 OK |
| GET FOTA update file | | | |
| Set | AT+UHTTPC=<profile_id>,100,<path> | OK | AT+UHTTPC=0,100,"/path/file.html" OK |
| Test | AT+UHTTPC=? | +UHTTPC: (list of supported <profile_id>s),(list of supported <http_command>s) | +UHTTPC: (0-3),(0-5),100 OK |

| Type | Syntax | Response | Example |
|------|--------|---|------------------|
| | | OK | |
| URC | | +UUHTTPCR: <profile_id>,<http_command>,<http_result>[,<http_status_code>,<md5_sum>] | +UUHTTPCR: 0,1,1 |

22.3.3 Defined values

| Parameter | Type | Description |
|-----------------------------|--------|--|
| <profile_id> | Number | HTTP profile identifier, in range 0-3 |
| <http_command> | Number | <ul style="list-style-type: none"> 0: HEAD command; issue an HEAD request to the HTTP server 1: GET command; perform a GET request to the HTTP server 2: DELETE command; send a DELETE request to the HTTP server 3: PUT command; perform a PUT request to the HTTP server. 4: POST a file command; issue a POST request for sending a file to the HTTP server 5: POST data command; send a POST request to the HTTP server using the data specified in <data> parameter 100: GET FOTA update file; download the FOTA update file |
| <path> | String | <p>Path of HTTP server resource; the maximum length is:</p> <ul style="list-style-type: none"> SARA-R422M8S / SARA-R422S - 1024 characters SARA-R410M-02B / SARA-R410M-52B / SARA-R410M-63B / SARA-R410M-73B / SARA-R410M-83B / SARA-R412M - 2048 characters SARA-R404M / SARA-R410M-01B / SARA-N4 - 256 characters <p> SARA-R410M-02B / SARA-R410M-52B / SARA-R412M On SARA-R410M-02B-00, SARA-R410M-02B-01, SARA-R410M-52B-00, SARA-R410M-52B-01, SARA-R412M-02B-00, SARA-R412M-02B-01 the maximum parameter length is 256 characters.</p> |
| <filename> | String | Filename where the HTTP server response will be stored. If the file already exists, it will be overwritten. If the parameter is an empty string (""), the default "http_last_response_<profile_id>" filename will be used. For file system file name and data size limits see File system limits . |
| <filesystem_name> | String | File system filename representing the file system filename to be sent to the HTTP server within the POST / PUT request. For file system file name and data size limits see File system limits . |
| <HTTP_content_type> | Number | <p>HTTP Content-Type identifier. It represents the HTTP Content-Type identifier. Allowed values:</p> <ul style="list-style-type: none"> 0: application/x-www-form-urlencoded 1: text/plain 2: application/octet-stream 3: multipart/form-data 4: application/json (supported only for PUT and POST file command) 5: application/xml 6: user defined with <user_defined_content_type> |
| <user_defined_content_type> | Number | Used only when <HTTP_content_type>=6 (user defined Content-Type). The maximum length is 64 characters. |
| <data> | String | It represents the data to be sent to the HTTP server with the POST request. The maximum length is 128 bytes. The data must be formatted according to the Content-Type specified in <HTTP_content_type> parameter. |
| <param1> | String | Content depends on the related <http_command> (see above). |
| <param2> | Number | Content depends on the related <http_command> (see above). |
| <param3> | String | Content depends on the related <http_command> (see above). |
| <http_result> | Number | <ul style="list-style-type: none"> 0: fail 1: success |
| <http_status_code> | Number | HTTP status code reported in the server response header after a GET FOTA update file request. This parameter is issued only for AT+UUHTTPCR=<profile_id>,100,<path> AT command. |
| <md5_sum> | String | MD5 checksum of the FOTA update file. This parameter is issued only for AT+UUHTTPCR=<profile_id>,100,<path> AT command. |

22.3.4 Notes

- The +UHTTPC command has a default timeout setting set to 180 s. The timeout is counted from the last successful network read or send operation performed by the HTTP application, so in a real timeout case the application might be executing a command more than 180 s.
- The data string must not exceed the maximum length of 128 bytes.
- If <http_command>=4 (POST a file) and the <HTTP_content_type>=3 (multipart/form-data), then the module automatically encapsulates the file content in the following multipart/form-data HTTP request:

```
--U1Blox2Http3Unique4Boundary5\r\n
Content-Disposition: form-data; name="file_post"; filename="<user_defined_content_type>"\r\n
Content-Length: <length of file specified with <user_defined_content_type>>\r\n
Content-Type: application/octet-stream\r\n
\r\n
<content of file specified with <user_defined_content_type>>\r\n
--U1Blox2Http3Unique4Boundary5--\r\n
\r\n
```

- The response headers string (headers received in the HTTP response) must not exceed the maximum length of 256 bytes.

SARA-R404M / SARA-R410M / SARA-R412M / SARA-N4

- <http_command>=100 is not supported.

SARA-R422M8S / SARA-R422S

- The time to establish the secure session (when using +UHTTP: <profile_id>,6,1[,<USECMNG_profile>]) could require up to 150 s in one of these cases:
 - o RoT generated PSK (+USECPRF: <profile_id>,11)
 - o encrypted session resumption (+USECPRF: <profile_id>,13,2,10)

This is due to "security heartbeat" message operation. For more details on when this scenario occurs, see the +USECCONN AT command.

22.4 HTTP protocol error +UHTTPER

| +UHTTPER | | | | | | |
|-------------------|---|---------------------|-----------------------|-----------------------|----------------------|----------------------------|
| Modules | SARA-R404M SARA-R410M SARA-R412M SARA-R422M8S SARA-R422S SARA-N4 | | | | | |
| Attributes | Syntax | PIN required | Settings saved | Can be aborted | Response time | Error reference |
| | full | No | No | No | - | +CME Error Appendix A.7 |

22.4.1 Description

Retrieves the error class and code of the latest HTTP operation on the specified HTTP profile.

22.4.2 Syntax

| Type | Syntax | Response | Example |
|------|-------------------------|---|---------------------------------------|
| Set | AT+UHTTPER=<profile_id> | +UHTTPER: <profile_id>,<error_class>,<error_code> OK | AT+UHTTPER=1 +UHTTPER: 1,0,0 OK |

22.4.3 Defined values

| Parameter | Type | Description |
|---------------|--------|---|
| <profile_id> | Number | HTTP profile identifier, in range 0-3 |
| <error_class> | Number | List of the allowed values is available in Appendix A.7 |

| Parameter | Type | Description |
|--------------|--------|---|
| <error_code> | Number | Value of class-specific error codes (reply code if class is 0). When <error_class>=10 (wrong HTTP API usage), the allowed <error_code>; values are listed in Appendix A.7.2 |

23 Ping



SARA-R422 / SARA-R422M8S / SARA-R422S

The ping service requires the user to define and activate a connection profile before executing the **+UPING** command. See **+UPSD** AT command for CID mapping and **+CGACT** for activating a PDP context.

23.1 Ping command +UPING

| +UPING | | | | | | |
|-------------------|-----------------------------------|---------------------|-----------------------|-----------------------|----------------------|--------------------------|
| Modules | SARA-R422 SARA-R422M8S SARA-R422S | | | | | |
| Attributes | Syntax | PIN required | Settings saved | Can be aborted | Response time | Error reference |
| | full | No | No | No | - | +CME Error PING Error |

23.1.1 Description

The ping command is the common method to know if a remote host is reachable on the internet.

The ping functionality is based on the ICMP protocol (Internet Control Message Protocol), it is part of the Internet Protocol Suite as defined in RFC 792 [161]. ICMP messages are typically generated in response to errors in IP datagrams or for diagnostic / routing purposes.

The ping command sends an ICMP echo request to the remote host and waits for its ICMP echo reply. If the echo reply packet is not received, it might mean that the remote host is not reachable.

The ping command could be used also to measure e.g. the RTT (Round Trip Time, the time needed by a packet to go to the remote host and come back) and the TTL (Time To Live, it is a value to understand how many gateway a packet has gone through).

The set command allows the user to execute a ping command from the module to a remote peer. The results of the ping command execution is notified by means of these URCs:

- **+UUPING:** it reports the +UPING command result when no error occurred.
- **+UUPINGER:** it is raised if an error is occurred while processing the +UPING command. The URC reports the code of occurred error (see [Ping error codes](#) to get the meanings of the error result codes).



Some network operators may disallow ICMP packets traffic on their network, this means that the +UPING command may not work.



Some remote hosts might not reply to ICMP echo request for security reasons (e.g. firewall settings).



Some remote hosts might not reply to ICMP echo request if the data size of the echo request is too big.



If a remote peer does not reply to an ICMP echo request, it does not mean that for sure the peer cannot be reached in another way.

23.1.2 Syntax

| Type | Syntax | Response | Example |
|------|---|--|--|
| Set | AT+UPING=<remote_host>[,<retry_num>,<p_size>,<timeout>,<tll>] | OK | AT+UPING="www.google.com" OK |
| Test | AT+UPING=? | +UPING: "remote_host",(list of supported <retry_num>),(list of supported <p_size>),(list of supported <timeout>),(list of supported <tll>) OK | +UPING: "remote_host",(1-64),(4-1460),(10-60000),(1-255) OK |
| URC | | +UUPING: <retry_num>,<p_size>,<remote_hostname>,<remote_ip>,<tll>,<rtt> | +UUPING: 1,32,"www.l-google.com", "72.14.234.104",55,768 |
| URC | | +UUPINGER: <error_code> | +UUPINGER: 12 |

23.1.3 Defined values

| Parameter | Type | Description |
|-------------------|--------|--|
| <remote_host> | String | IP address (dotted decimal representation) or domain name of the remote host: <ul style="list-style-type: none"> • Maximum length: 128 characters |
| <retry_num> | Number | Indicates how many times iterate the ping command: <ul style="list-style-type: none"> • Range: 1-64 • Default value: 4 |
| <p_size> | Number | Size in bytes of the echo packet payload: |
| <timeout> | Number | The maximum time in milliseconds to wait for a echo reply response: <ul style="list-style-type: none"> • Range: 10-60000 • Default value: 5000 |
| <ttl> | Number | The value of TTL to be set for the outgoing echo request packet. In the URC it provides the TTL value received in the incoming packet: <ul style="list-style-type: none"> • Range: 1-255 • Default value: 32 |
| <remote_hostname> | String | String representing the domain name (if available) of the remote host. If this information is not available, it will be an empty string (i.e. ""). |
| <remote_ip> | String | String representing the remote host IP address in dotted decimal form. |
| <rtt> | Number | RTT value, the time elapsed in milliseconds before receiving the echo reply response from the remote host. |
| <error_code> | Number | The error occurred while processing the +UPING command. See Ping error codes for the list of the allowed error result codes. |

23.1.4 Notes

- If the +UUPING URC reports <rtt> = -1 the timeout is elapsed (no response received).
- If the first +UUPING URC reports <rtt> = -2 the TTL used in the ping request is too low.
- Some network operators may return an ICMP time exceeded message when the remote host is not reachable. In these cases the first +UUPING URC reports <rtt> = -1 and the subsequent +UUPING URC report <rtt> = -2.

SARA-R422 / SARA-R422M8S / SARA-R422S

- The <ttl> parameter is not supported.

24 Positioning

24.1 NMEA



u-blox cellular modules support reading NMEA strings from the GNSS receiver through AT commands.

Before being able to read a specific NMEA string, it is necessary to activate the storage of the last value of that particular NMEA string. If storing a particular NMEA string was not activated, the information text response to the query will be "0,NULL". The last value of a specific NMEA string is saved in RAM and is made available even after the GNSS receiver switch off.

The NMEA standard differentiates between GPS, GLONASS, GALILEO, BeiDou and multi-GNSS receivers using a different 'Talker ID'. Depending upon device model and system configuration, the u-blox receiver could output messages using any one of these Talker IDs.

By default, the receivers configured to support GPS, SBAS and QZSS use the 'GP' Talker ID, receivers configured to support GLONASS use the 'GL' Talker ID, receivers configured to support BeiDou use the 'GB' Talker ID, receivers configured to support GALILEO use the 'GA' Talker ID and receivers configured for any combinations of multiple GNSS use the 'GN' Talker ID.

Even if the NMEA specification indicates that the GGA message is GPS specific, u-blox receivers support the output of a GGA message for each of the Talker IDs.

-  As a factory-programmed setting, the cellular modules configure the GNSS receiver through **+UGPS** AT command to not provide the NMEA sentences.
-  When reading an NMEA message, if the response value is "1,Not available" then the storing of the NMEA string is activated but this information has not been still sent to the user, if this persists check that the relative NMEA message is enabled. To enable it use the **+UGUBX** AT command (for further information see the UBX-CFG-MSG message in the u-blox GNSS protocol specification).

24.2 AssistNow services

Users would ideally like GNSS receivers to provide accurate position information the moment they are turned on. With standard GNSS receivers there can be a significant delay in providing the first position fix, principally because the receiver needs to obtain data from several satellites and the satellites transmit that data slowly. Under adverse signal conditions, data downloads from the satellites to the receiver can take minutes, hours or even fail altogether.

GNSS AT commands provides the means for delivering assistance data to u-blox receivers obtained from the u-blox AssistNow Online or AssistNow Offline services.

AssistNow Online is u-blox' end-to-end Assisted GNSS (A-GNSS) solution for use cases that have access to the Internet. Data supplied by the AssistNow Online service can be directly uploaded to a u-blox receiver to substantially reduce Time To First Fix (TTFF), even under poor signal conditions.

AssistNow Offline service is targeted at use cases that only have occasional Internet access and so cannot use AssistNow Online. AssistNow Offline speeds up Time To First Fix (TTFF), typically to considerably less than 10 s. Cellular modules using AssistNow Offline download data from the AssistNow Offline service when an Internet connection is available. Data are stored locally to the cellular module file system and are subsequently uploaded to a u-blox receiver, so that it can estimate the positions of the satellites, when no better data is available. Using these estimates will not provide as accurate a position fix as if current ephemeris data is used, but it will allow much faster TTFFs in nearly all cases.

Both the AssistNow Online and Offline services use a simple, stateless, HTTP interface. Therefore, they work on all standard mobile communication networks that support Internet access.

-  UDP protocol for the AssistNow Online service is deprecated.

Both the AssistNow Online and Offline services are only available for use by u-blox customers. To use the services, customers will need to obtain an authorization token from u-blox. This token must be issued as a parameter of **+UGSRV** AT command.

AssistNow Autonomous feature provides a functionality similar to AssistNow Offline without the need for a host and a connection. Based on a broadcast ephemeris downloaded from the satellite the receiver can

autonomously generate an accurate satellite orbit representation («AssistNow Autonomous data») that is usable for navigation much longer than the underlying broadcast ephemeris was intended for.

Local Aiding feature provides a functionality so that u-blox receivers is instructed to dump the current state of their internal navigation database to the cellular module file system. This information is sent back to the receiver (e.g. after a period when the receiver was turned off) restoring the database to its former state, and thus allows the receiver to restart rapidly. Local aiding feature does not need for a access to the Internet.

The **+UGPS** AT command allows the activation/deactivation of AssistNow Online, Offline, Autonomous and Local Aiding features.

The AssistNow Offline and AssistNow Autonomous features are exclusive and should not be used at the same time. Every satellite will be ignored by AssistNow Autonomous if there is AssistNow Offline data available for it.

Table 31 summarizes the GNSS AT commands related with AssistNow services:

| AT command | AssistNow Online | AssistNow Offline | AssistNow Autonomous | Local Aiding |
|---------------|--|--|--------------------------------------|---|
| +UGPS | Enable/disable the feature | Enable/disable the feature | Enable/disable the feature | Enable/disable the feature |
| +UGAOP | Configure UDP for A-GPS (deprecated) | | | |
| +UGAOF | | Configure HTTP for A-GPS (deprecated) | | |
| +UGSRV | Configure HTTP for A-GNSS Configure Auth Token for A-GNSS | Configure HTTP for A-GNSS Configure Auth Token for A-GNSS | | |
| +UGAOS | Force AssistNow Online data download request | Force AssistNow Offline data download request | Force AssistNow Autonomous operation | Download/Upload of local aiding data from/to GNSS receiver to cellular module |

Table 31: AssistNow services Overview

24.3 GNSS

24.3.1 GNSS power management +UGPS

| +UGPS | | | | | | |
|-------------------|---|---------------------|-----------------------|-----------------------|----------------------|------------------------|
| Modules | SARA-R410M-02B SARA-R410M-52B SARA-R410M-63B SARA-R410M-73B SARA-R410M-83B SARA-R412M SARA-R422M8S SARA-R422S SARA-N4 | | | | | |
| Attributes | Syntax | PIN required | Settings saved | Can be aborted | Response time | Error reference |
| | full | No | No | No | < 10 s | +CME Error |

24.3.1.1 Description

Switches on or off a u-blox GNSS receiver connected to the cellular module via a dedicated DDC (I²C) interface. For more details about the connection between cellular module and u-blox GNSS receiver, see the corresponding module system integration manual.

Furthermore the command sets the aiding type to be used to enhance GNSS performance, e.g. decreasing Time To First Fix (TTFF). The supported aiding types are: Local aiding, AssistNow Online, AssistNow Offline, AssistNow Autonomous.

For a more detailed description on aiding modes and possible suggestions, see [AssistNow services](#).

- SARA-R410M / SARA-R412M / SARA-R422M8S / SARA-R422S / SARA-N4
See **+UPSD** AT command for CID mapping and **+CGACT** for activating a PDP context.
- The AssistNow Autonomous feature may be not fully supported on all Multi-GNSS receivers. For more details on AssistNow Autonomous feature see the corresponding u-blox-GNSS receiver description.
- SARA-R4
For a more detailed description on aiding modes and possible suggestions, see SARA-R4 / SARA-R5 series positioning implementation application note [54].

It is possible to combine different aiding modes: to enable them the sum of the <mode> value of the interested aiding modes is needed (e.g.: aiding <aid_mode>=3 means local aiding plus AssistNow Offline). Moreover it is also possible to switch from one aiding mode to another one without powering off the GNSS receiver. If the following sequence is provided (AT+UGPS=1,1 and then AT+UGPS=1,5) at the beginning the GNSS receiver will power on with local aiding support and after the second command will be added the AssistNow Online. After the second command the local aiding is not restarted, therefore the +UUGIND URC for it will not be sent again.

u-blox concurrent GNSS receivers can acquire and track satellites from more than one GNSS system at the same time. The <GNSS_systems> parameter configures the GNSS receiver into the required mode of operation. It is possible to combine different GNSS systems depending on the receivers capability to receive several carrier frequencies. See the corresponding GNSS receiver data sheet for the supported GNSS systems. If the Assisted GNSS unsolicited indication is enabled, the +UUGIND URC will provide the current activated combinations of systems.

24.3.1.2 Syntax

| Type | Syntax | Response | Example |
|------|--|--|---------------------|
| Set | AT+UGPS=<mode>[,<aid_mode>[,<GNSS_systems>]] | OK | AT+UGPS=1,0,1 OK |
| Read | AT+UGPS? | +UGPS: <mode>[,<aid_mode>[,<GNSS_systems>]] OK | +UGPS: 1,0,1 OK |
| Test | AT+UGPS=? | +UGPS: (list of supported <mode>s), +UGPS: (0-1),(0-15),(1-127) (list of supported <aid_mode>),(list of supported <GNSS_systems>) OK | OK |

24.3.1.3 Defined values

| Parameter | Type | Description |
|----------------|--------|---|
| <mode> | Number | <ul style="list-style-type: none"> 0 (default value): GNSS receiver powered off 1: GNSS receiver powered on |
| <aid_mode> | Number | Supported aiding modes; the parameter is mandatory if <mode>=1; all these allowed values can be combined together: <ul style="list-style-type: none"> 0 (default value): no aiding 1: automatic local aiding 2: AssistNow Offline 4: AssistNow Online 8: AssistNow Autonomous |
| <GNSS_systems> | Number | Bitmask for combining the supported GNSS types; the parameter is optional and the allowed values can be combined together. The default value is 3 (GPS+SBAS): <ul style="list-style-type: none"> 1: GPS 2: SBAS 4: Galileo 8: BeiDou 16: IMES 32: QZSS 64: GLONASS |

24.3.1.4 Notes

- If <GNSS_systems> type is not supported by the GNSS receiver, the set command turns on the GNSS receiver with built-in supported type. The current <GNSS_systems> can be queried by means of the read command or the +UUGIND URC.
- An error result code is provided in the following cases:
 - <mode>, <aid_mode> or <GNSS_systems> values are out of range
 - <mode> is set to 1 without <aid_mode> value
 - Attempt to power off the GNSS when it is already off
 - The value of <aid_mode> to be set is equal to the current GNSS aiding mode and the value of <GNSS_systems> to be set is equal to the last requested <GNSS_systems>

24.3.2 Assisted GNSS unsolicited indication +UGIND

| +UGIND | | | | | | |
|-------------------|---|---------------------|-----------------------|-----------------------|----------------------|------------------------|
| Modules | SARA-R410M-02B SARA-R410M-52B SARA-R410M-63B SARA-R410M-73B SARA-R410M-83B SARA-R412M SARA-R422M8S SARA-R422S SARA-N4 | | | | | |
| Attributes | Syntax | PIN required | Settings saved | Can be aborted | Response time | Error reference |
| | full | No | NVM | No | - | +CME Error |

24.3.2.1 Description

Enables or disables sending of URCs from MT to TE in the case of GNSS aiding operations. The <mode> parameter controls the processing of URCs specified within this command.

The URC returns the result of an assisted GNSS operation. This information is sent to all the interfaces. The URC is provided only if one or more aiding modes are enabled (for more details, see the +UGPS and +UGAOP command descriptions).

There can be more than a +UUGIND URC for a single aiding operation: the +UUGIND is reported for each error. For instance if the local aiding is enabled and there are no space left in the file system after the AT+UGPS=0 command, there will be an error for every failure writing on FFS.

The AT+UGAOS=0 and AT+UGAOS=1 commands both relate to the GNSS local aiding, so the unsolicited message will be +UUGIND: 1,x in both cases.

Local aiding and AssistNow Autonomous will produce URC both after GNSS power on and before GNSS power off because some data are transferred from the GNSS receiver to the cellular module.

As the GNSS receiver can be configured for multi-GNSS, an additional +UUGIND: 0,<GNSS_systems> URC for the currently activated GNSS systems is displayed.

24.3.2.2 Syntax

| Type | Syntax | Response | Example |
|------|-----------------|--|----------------------------------|
| Set | AT+UGIND=<mode> | OK | AT+UGIND=1 OK |
| Read | AT+UGIND? | +UGIND: <mode> OK | +UGIND: 1 OK |
| Test | AT+UGIND=? | +UGIND: (list of supported <mode>'s) OK | +UGIND: (0-1) OK |
| URC | | Current activated GNSS system: +UUGIND: 0,<GNSS_systems> GNSS aiding status: +UUGIND: <aid_mode>,<result> | +UUGIND: 0,3 +UUGIND: 4,5 |

24.3.2.3 Defined values

| Parameter | Type | Description |
|----------------|--------|--|
| <mode> | Number | URC configuration: <ul style="list-style-type: none"> 0 (default value): disabled 1: enabled |
| <aid_mode> | Number | Provides the supported aiding mode: <ul style="list-style-type: none"> 0: GNSS system(s) 1: automatic local aiding 2: AssistNow Offline 4: AssistNow Online 8: AssistNow Autonomous |
| <GNSS_systems> | Number | Current activated GNSS types; the allowed values can be combined together: <ul style="list-style-type: none"> 1: GPS 2: SBAS 4: Galileo 8: BeiDou |

| Parameter | Type | Description |
|-----------|--------|---|
| | | <ul style="list-style-type: none"> 16: IMES 32: QZSS 64: GLONASS |
| <result> | Number | Represents the result of the aiding operation: <ul style="list-style-type: none"> 0: no error 1: wrong URL (for AssistNow Offline) 2: HTTP error (for AssistNow Offline) 3: create socket error (for AssistNow Online) 4: close socket error (for AssistNow Online) 5: write to socket error (for AssistNow Online) 6: read from socket error (for AssistNow Online) 7: connection/DNS error (for AssistNow Online) 8: file system error 9: generic error 10: no answer from GNSS (for local aiding and AssistNow Autonomous) 11: data collection in progress (for local aiding) 12: GNSS configuration failed (for AssistNow Autonomous) 13: RTC calibration failed (for local aiding) 14: feature not supported (for AssistNow Autonomous) 15: feature partially supported (for AssistNow Autonomous) 16: authentication token missing (required for aiding for u-blox M8 and future versions) |

24.3.2.4 Notes

SARA-R422M8S / SARA-R422S

- The command setting is not stored in the NVM.

24.3.3 GNSS profile configuration +UGPRF

| +UGPRF | | | | | | |
|-------------------|---|---------------------|-----------------------|-----------------------|----------------------|------------------------|
| Modules | SARA-R410M-02B SARA-R410M-52B SARA-R410M-63B SARA-R410M-73B SARA-R410M-83B SARA-R412M SARA-R422M8S SARA-R422S SARA-N4 | | | | | |
| Attributes | Syntax | PIN required | Settings saved | Can be aborted | Response time | Error reference |
| | full | No | NVM | No | - | +CME Error |

24.3.3.1 Description

Configures the data flow to and from a u-blox GNSS receiver connected to the cellular module. The data flow is possible to and from the:

- UART (via multiplexer)
- USB (or alternatively AUX UART)
- Over the air to a remote host: To send data over the air an internet connection must be active and there must be at least one free TCP socket (the GNSS shares the socket pool with the other applications). Setting up an Internet connection and network registration is not part of this command and must be handled by the user separately from this command.
- Into a file on the cellular module: A file with GNSS data can be accessed via the [+ULSTFILE](#) AT command. The filename is automatically chosen by the cellular module as a unique ID based on date and time or a further incremental number (e.g. "GPS_200910061500" or "GPS_20091006_001" according to the used cellular module). When the files size reaches 500 kB the file is closed and no more data is saved. It is possible to save further data by restarting the GNSS (this will create a new file)



SARA-R410M / SARA-R412M / SARA-R422M8S / SARA-R422S / SARA-N4

See [+UPSD](#) AT command for CID mapping and [+CGACT](#) for activating a PDP context.

It is possible to send GNSS data to multiple destinations at the same time by summing the <GNSS_I/O_configuration> values of each required destinations (e.g. if AT+UGPRF=6 the data will be sent on multiplexer and stored in a file in the file system).

The messages to be output by the u-blox GNSS receiver need to be activated separately with UBX-CFG-MSG configuration messages according to the GNSS receiver protocol specification.

- It is not possible to select the GNSS data flow to and from USB (or alternatively AUX UART) and multiplexer concurrently.
- The configuration of the GNSS profile must be performed only when GNSS is switched off, otherwise an error result code will be displayed.
- SARA-R422M8S / SARA-R422S
AUX UART interface can be configured as GNSS tunneling. See [+USIO](#) AT command description for details.

24.3.3.2 Syntax

| Type | Syntax | Response | Example |
|------|---|--|--|
| Set | AT+UGPRF=<GNSS_I/O_configuration>[,<IP Port>,<server address string>] | OK | AT+UGPRF=0 OK |
| Read | AT+UGPRF? | +UGPRF: <GNSS_I/O_configuration>,<IP port>,<server address string> OK | +UGPRF: 0,0,"" OK |
| Test | AT+UGPRF=? | +UGPRF: (list of supported <GNSS_I/O_configuration>),(list of supported <IP port>),<server address string> OK | +UGPRF: (0-127),(0-65535),"addr" OK |

24.3.3.3 Defined values

| Parameter | Type | Description |
|-------------------------|--------|--|
| <GNSS_IO_configuration> | Number | <ul style="list-style-type: none"> • 0: no data flow to multiplexer, file or IP address • 1: GNSS data flow to and from USB (or alternatively AUX UART) • 2: GNSS data flow to and from multiplexer • 4: GNSS data flow saved to file • 8: GNSS data flow over the air to an Internet host • 16: GNSS data ready function • 32: GNSS RTC sharing function • 64: reserved • 128: reset the GNSS after the GNSS power on (see AT+UGPS command description) • 256: reserved <p>Allowed values:</p> <ul style="list-style-type: none"> • SARA-R422S - 0 (factory-programmed value), 1, 2, 4, 8, 16, 64, 128 • SARA-R422M8S - 0 (factory-programmed value), 1, 2, 4, 8, 16, 64, 128 • SARA-R410M-02B / SARA-R410M-63B / SARA-R410M-73B / SARA-R410M-83B / SARA-R412M - 0 (factory-programmed value), 2, 4, 8, 16, 64, 128 • SARA-R410M-52B / SARA-N4 - 0 (factory-programmed value), 2, 4, 8, 16, 64 <p> SARA-R410M-02B / SARA-R412M On SARA-R410M-02B-00, SARA-R410M-02B-01, SARA-R410M-02B-02, SARA-R412M-02B-00, SARA-R412M-02B-01, SARA-R412M-02B-02 allowed values are: 0 (factory-programmed value), 2, 4, 8, 16, 64.</p> |
| <IP port> | Number | IP port of the server where the GNSS data are sent (default and factory-programmed value: 0). If GNSS data flow over the air is enabled the parameter is mandatory otherwise is forbidden. |
| <server address string> | String | Address string of the server where the GNSS data are sent (default and factory-programmed value: ""). If GNSS data flow over the air is enabled the parameter is mandatory otherwise is forbidden. The address could be provided in both URL or IP format and the maximum length of the string is 47 characters. |

24.3.3.4 Notes

SARA-R410M / SARA-R412M / SARA-N4

- The GNSS data flow on the multiplexer channel is only in output toward the cellular module; the input to the GNSS receiver is not supported.
- The GNSS multiplexer channel accepts AT commands towards the cellular module.

SARA-R422M8S / SARA-R422S

- When the AUX UART interface configuration as GNSS tunneling becomes active (see the [+USIO](#) AT command), the AUX UART interface baud rate is fixed to 115200 b/s and cannot be modified.

24.3.4 Aiding server configuration +UGSRV

| +UGSRV | | | | | | |
|-------------------|---|---------------------|-----------------------|-----------------------|----------------------|----------------------------|
| Modules | SARA-R410M-02B SARA-R410M-52B SARA-R410M-63B SARA-R410M-73B SARA-R410M-83B SARA-R412M SARA-R422M8S SARA-R422S SARA-N4 | | | | | |
| Attributes | Syntax | PIN required | Settings saved | Can be aborted | Response time | Error reference |
| | partial | No | NVM | No | - | +CME Error |

24.3.4.1 Description

Configures the network connection to a Multi GNSS Assistance (MGA) server. The configuration is saved in NVM and applied at the next GNSS power cycle. By default, the cellular module connects to u-blox' primary MGA server; if the connection fails then the cellular module connects to u-blox' secondary MGA server. The set command registers a token for gathering assistance data from MGA servers.

Setting up Internet connection and network registration is not part of this command and must be handled by the user separately to this command.

SARA-R410M / SARA-R412M / SARA-R422M8S / SARA-R422S / SARA-N4
See [+UPSD](#) AT command for CID mapping and [+CGACT](#) for activating a PDP context.

For more details about Multi GNSS Assistance (MGA) feature please refer to [AssistNow services](#).

24.3.4.2 Syntax

| Type | Syntax | Response | Example |
|------|---|--|---|
| Set | AT+UGSRV=[<mga_primary_server>],[<mga_secondary_server>],<auth_token>[,<days>[,<period>[,<resolution>[,<GNSS_types>[,<mode>[,<datatype>]]]]]] | OK | AT+UGSRV="cell-live1.services.u-blox.com","cell-live2.services.u-blox.com","123456789abcdefghijklmnopq",14,4,1,65,0,1 OK |
| Read | AT+UGSRV? | +UGSRV: <mga_primary_server>,<mga_secondary_server>,<auth_token>,<days>,<period>,<resolution>,<GNSS_types>,<mode>,<datatype> OK | +UGSRV: "cell-live1.services.u-blox.com","cell-live2.services.u-blox.com","123456789abcdefghijklmnopq",14,4,1,65,0,1 OK |
| Test | AT+UGSRV=? | +UGSRV: <mga_primary_server>,<mga_secondary_server>,<auth_token>,(list of supported <days>s),(list of supported <period>s),(list of supported <resolution>s),(list of supported <GNSS_types>s),(list of supported <mode>s),(list of supported <datatype>s) OK | +UGSRV: "srv1","srv2","token",(1,2,3,5,7,10,14),(1-5),(1-3),(1,64,65),(0-2),(0-15) OK |

24.3.4.3 Defined values

| Parameter | Type | Description |
|----------------------|--------|--|
| <mga_primary_server> | String | Host name of the primary MGA server; the maximum length is 254 characters. Empty string is not allowed. The default and factory-programmed value is "cell- |

| Parameter | Type | Description |
|------------------------|--------|---|
| | | live1.services.u-blox.com". If the primary MGA server is omitted, the current stored value is preserved. |
| <mga_secondary_server> | String | Host name of the secondary MGA server; the maximum length is 254 characters. Empty string is not allowed. The default and factory-programmed value is "cell-live2.services.u-blox.com". If the secondary MGA server is omitted, the current stored value is preserved. |
| <auth_token> | String | Authentication Token for MGA server access. |
| <days> | Number | The number of days into the future the Offline data for u-blox 7 and previous version should be valid for. The allowed values are: 1, 2, 3, 5, 7, 10 and 14. The default and factory-programmed value is 14. |
| <period> | Number | The number of weeks into the future the Offline data for u-blox M8 should be valid for. The range of the allowed values goes from 1 to 5. The default and factory-programmed value is 4. |
| <resolution> | Number | Resolution of offline data for u-blox M8. Allowed values: <ul style="list-style-type: none"> • 1 (default and factory-programmed value): every day • 2: every other day • 3: every third day |
| <GNSS_types> | Number | Bitmask for combining the desired GNSS for the (offline) aiding <ul style="list-style-type: none"> • 1: GPS • 64: GLONASS The default and factory-programmed value is all (65). If the parameter is omitted, the current stored value is preserved. |
| <mode> | Number | Mode of operation of AssistNow Online data management <ul style="list-style-type: none"> • 0 (default and factory-programmed value): AssistNow Online data are downloaded at GNSS receiver power up • 1: AssistNow Online data automatically kept alive • 2: manual AssistNow Online data download |
| <datatype> | Number | Bitmask for combining the desired data types for the (online) aiding <ul style="list-style-type: none"> • 0: time • 1: position • 2: ephemeris • 4: almanac • 8: auxiliary • 16: ephemeris of satellites which are likely to be visible from the position estimated by current registered network. This flag has no effect if the ephemeris flag is set to 0. The default and factory-programmed value is all aidings without filter on visible satellites (15) |

24.3.4.4 Notes

SARA-R4 / SARA-N4

- <datatype>=16 is not supported.

24.3.5 GNSS aiding request command +UGAOS

| +UGAOS | | | | | | |
|-------------------|---|---------------------|-----------------------|-----------------------|----------------------|------------------------|
| Modules | SARA-R410M-02B SARA-R410M-52B SARA-R410M-63B SARA-R410M-73B SARA-R410M-83B SARA-R412M SARA-R422M8S SARA-R422S SARA-N4 | | | | | |
| Attributes | Syntax | PIN required | Settings saved | Can be aborted | Response time | Error reference |
| | full | No | No | No | < 10 s | +CME Error |

24.3.5.1 Description

Triggers the manual download of AssistNow Online and AssistNow Offline data from the configured server in case automatic AssistNow operation is not enabled. The command returns only when the received data from the server are valid or an error occurs.

The command is also used to trigger the manual upload of local aiding data (e.g. ephemeris, almanac, last position, time, etc) from a u-blox GNSS receiver prior to shutting it down and to restore it into the receiver after the power up of the GNSS receiver (for more details, see the [+UGPS](#) AT command).

24.3.5.2 Syntax

| Type | Syntax | Response | Example |
|------|---------------------|---|---------------------|
| Set | AT+UGAOS=<aid_mode> | OK | AT+UGAOS=0 OK |
| Test | AT+UGAOS=? | AT+UGAOS: (list of supported <aid_mode>s) OK | +UGAOS: (0-8) OK |

24.3.5.3 Defined values

| Parameter | Type | Description |
|------------|--------|--|
| <aid_mode> | Number | Allowed values: <ul style="list-style-type: none"> 0: upload of local aiding data from GNSS receiver to cellular module 1: download of local aiding data from the cellular module to the GNSS receiver 2: AssistNow Offline file download request (file loaded into cellular module) 4: AssistNow Online data download request (data loaded into the GNSS receiver). This is only needed if AssistNow Online is not used with automatic operation 8: AssistNow autonomous Other values are reserved for future use |

24.3.6 Send of UBX string +UGUBX

| +UGUBX | | | | | | |
|-------------------|---|---------------------|-----------------------|-----------------------|----------------------|------------------------|
| Modules | SARA-R410M-02B SARA-R410M-52B SARA-R410M-63B SARA-R410M-73B SARA-R410M-83B SARA-R412M SARA-R422M8S SARA-R422S SARA-N4 | | | | | |
| Attributes | Syntax | PIN required | Settings saved | Can be aborted | Response time | Error reference |
| | full | No | No | No | < 10 s | +CME Error |

24.3.6.1 Description

Sends UBX protocol messages, embedded in an AT command, to a u-blox GNSS receiver. The command is transparent, that is the data is sent to the GNSS receiver without any check: it is up to the user to control if the UBX data is valid. The checksum in +UGUBX command string is ignored, this is calculated when the data is sent to the GNSS receiver.

When the GNSS receiver is off the UBX string is saved in cellular module RAM and, later, passed to the GNSS as configuration for "GNSS data ready" function when the GNSS receiver is used. In this case the UBX checksum bytes must be filled correctly.

It is recommended to not send UBX messages to reset the GNSS receiver while it is in use, this will cause a misalignment between the cellular system configuration and the one of the GNSS system.

UBX messages of "input" type do not provide back information messages to the cellular module. In this case the information text response to set command is +UGUBX: "no message" followed by the final result code.

24.3.6.2 Syntax

| Type | Syntax | Response | Example |
|------|-----------------------|-------------------------------------|---|
| Set | AT+UGUBX=<UBX_string> | +UGUBX: <UBX_string_response> OK | AT+UGUBX="B56206010800010600 010000000017DA" +UGUBX: "B5620501020006010F38" OK |

24.3.6.3 Defined values

| Parameter | Type | Description |
|--------------|--------|--|
| <UBX_string> | String | UBX message in hexadecimal format. The messages can include spaces to simplify copy/paste from u-center separated with spaces, e.g. AT+UGUBX="B5 62 06 01 08 0 0 01 06 00 01 00 00 00 00 17 DA" (this is important when copying messages from u-center). <ul style="list-style-type: none"> SARA-R4 / SARA-N4 - The maximum length is 256 hexadecimal characters. |

| Parameter | Type | Description |
|-----------------------|--------|--|
| <UBX_string_response> | String | The response message depends by the request sent: query/poll UBX messages will return the requested data in hexadecimal format, while the configuration message will return the corresponding acknowledge or not-acknowledge. See the UBX protocol specification |

24.3.6.4 Notes

- If a +UGUBX command triggers multiple strings answer only a single UBX string is returned. E. g. polling GPS Aiding Ephemeris Data (AID-EPH) is done by sending a single message to the receiver but returns 32 messages; only the first one is sent to AT interface.
- The answer can be split in multiple information text responses all starting with "+UGUBX:".

SARA-R410M-02B / SARA-R410M-52B / SARA-N4

- If a UBX message of "input" type is sent to the GNSS receiver by means of the set command, only the final result code is returned.

24.3.7 GNSS indications timer +UGTMR

| +UGTMR | | | | | | |
|-------------------|---|---------------------|-----------------------|-----------------------|----------------------|------------------------|
| Modules | SARA-R410M-02B SARA-R410M-52B SARA-R410M-63B SARA-R410M-73B SARA-R410M-83B SARA-R412M SARA-R422M8S SARA-R422S SARA-N4 | | | | | |
| Attributes | Syntax | PIN required | Settings saved | Can be aborted | Response time | Error reference |
| | full | No | No | No | < 10 s | +CME Error |

24.3.7.1 Description

Sets the date and time format. With the <time_zone> parameter is possible to set the time zone value; the time and the date will be updated as the local time. With the action command is possible to synchronize the UTC timing.

24.3.7.2 Syntax

| Type | Syntax | Response | Example |
|------|----------------------|--|--------------------------|
| Set | AT+UGTMR=<time_zone> | OK | AT+UGTMR=-1 OK |
| Read | AT+UGTMR? | +UGTMR: <time_zone> OK | +UGTMR: -1 OK |
| Test | AT+UGTMR=? | +UGTMR: (list of supported <time_zone>s) OK | +UGTMR: (-96 - 96) OK |

24.3.7.3 Defined values

| Parameter | Type | Description |
|-------------|--------|---|
| <time_zone> | Number | Indicates the time zone value set by the user; the module can provide an error result code if the offset has not been calculated. The factory-programmed time zone value is 0. <ul style="list-style-type: none"> • -96, 96: defined range |

24.3.7.4 Notes

- The time zone is expressed in quarters of hour.
- The time is updated with the current UTC time plus the time zone and the time zone is unchanged, for example:

| Command | Response | Remarks |
|--------------|-------------------------------|--|
| AT+UGTMR=-36 | OK | The command returns the "OK" final result code and sets the new date and time if the GNSS has this information, otherwise a generic error result code is returned. |
| AT+CCLK? | +CCLK: "12/05/23,21:54:21+00" | |

24.3.8 Get GNSS time and date +UGZDA

| +UGZDA | | | | | | |
|-------------------|---|---------------------|-----------------------|-----------------------|----------------------|------------------------|
| Modules | SARA-R410M-02B SARA-R410M-52B SARA-R410M-63B SARA-R410M-73B SARA-R410M-83B SARA-R412M SARA-R422M8S SARA-R422S SARA-N4 | | | | | |
| Attributes | Syntax | PIN required | Settings saved | Can be aborted | Response time | Error reference |
| | full | No | NVM | No | < 10 s | +CME Error |

24.3.8.1 Description

Enables/disables the storing of the last value of NMEA \$ZDA messages, and get the current messaging state. If the <state> parameter is enabled, the last value of NMEA \$ZDA messages can be retrieved with the read command even when the GNSS is switched off.

The NMEA \$ZDA messages are volatile.

24.3.8.2 Syntax

| Type | Syntax | Response | Example |
|------|------------------|--|---|
| Set | AT+UGZDA=<state> | OK | AT+UGZDA=1 OK |
| Read | AT+UGZDA? | +UGZDA: <state>,<\$ZDA msg> OK | +UGZDA: 1,\$GPZDA,142351.00,12,12,2013,00,00*66 OK +UGZDA: 0,NULL OK |
| Test | AT+UGZDA=? | +UGZDA: (list of supported <state>s) OK | +UGZDA: (0-1) OK |

24.3.8.3 Defined values

| Parameter | Type | Description |
|-------------|--------|--|
| <state> | Number | <ul style="list-style-type: none"> 0 (factory-programmed value): disable the NMEA \$ZDA messages 1: enable the NMEA \$ZDA messages |
| <\$ZDA msg> | String | NMEA \$ZDA messages or "Not available" if the NMEA string is enabled, but this information has not been still sent to the user. |

24.3.9 Get GNSS fix data +UGGGA

| +UGGGA | | | | | | |
|-------------------|---|---------------------|-----------------------|-----------------------|----------------------|------------------------|
| Modules | SARA-R410M-02B SARA-R410M-52B SARA-R410M-63B SARA-R410M-73B SARA-R410M-83B SARA-R412M SARA-R422M8S SARA-R422S SARA-N4 | | | | | |
| Attributes | Syntax | PIN required | Settings saved | Can be aborted | Response time | Error reference |
| | full | No | NVM | No | < 10 s | +CME Error |

24.3.9.1 Description

Enables/disables the storing of the last value of NMEA \$GGA messages, and gets the current messaging state. If the <state> parameter is enabled, the last value of NMEA \$GGA messages can be retrieved with the read command even when the GNSS is switched off.

The NMEA \$GGA messages are volatile.

24.3.9.2 Syntax

| Type | Syntax | Response | Example |
|------|------------------|-----------------------------------|---|
| Set | AT+UGGGA=<state> | OK | AT+UGGGA=1 OK |
| Read | AT+UGGGA? | +UGGGA: <state>,<\$GGA msg> OK | +UGGGA: 1,\$GPZDA,142351.00,,,,,0,0,99.99,,,,,*66 |

| Type | Syntax | Response | Example |
|------|------------|--|----------------------------|
| | | | OK +UGGGA: 0,NULL OK |
| Test | AT+UGGGA=? | +UGGGA: (list of supported <state>s) OK | +UGGGA: (0-1) OK |

24.3.9.3 Defined values

| Parameter | Type | Description |
|-------------|--------|--|
| <state> | Number | <ul style="list-style-type: none"> 0 (factory-programmed value): to disable the NMEA \$GGA messages 1: to enable the NMEA \$GGA messages |
| <\$GGA msg> | String | NMEA \$GGA messages or "Not available" if the NMEA string is enabled, but this information has not been still sent to the user. |

24.3.10 Get geographic position +UGLL

| +UGLL | | | | | | |
|----------------|---|--------------|----------------|----------------|---------------|-----------------|
| Modules | SARA-R410M-02B SARA-R410M-52B SARA-R410M-63B SARA-R410M-73B SARA-R410M-83B SARA-R412M SARA-R422M8S SARA-R422S SARA-N4 | | | | | |
| Attributes | Syntax | PIN required | Settings saved | Can be aborted | Response time | Error reference |
| | full | No | NVM | No | < 10 s | +CME Error |

24.3.10.1 Description

Enables/disables the storing of the last value of NMEA \$GLL messages, and gets the current messaging state. If the <state> parameter is enabled, the last value of NMEA \$GLL messages can be retrieved with the read command even when the GNSS is switched off.

The NMEA \$GLL messages are volatile.

24.3.10.2 Syntax

| Type | Syntax | Response | Example |
|------|-----------------|---|--|
| Set | AT+UGLL=<state> | OK | AT+UGLL=1 OK |
| Read | AT+UGLL? | +UGLL: <state>,<\$GLL msg> OK | +UGLL: 1,\$GPGLL,,,,,142351.00,V, N*4A OK +UGLL: 0,NULL OK |
| Test | AT+UGLL=? | +UGLL: (list of supported <state>s) OK | +UGLL: (0-1) OK |

24.3.10.3 Defined values

| Parameter | Type | Description |
|-------------|--------|--|
| <state> | Number | <ul style="list-style-type: none"> 0 (factory-programmed value): to disable the NMEA \$GLL messages 1: to enable the NMEA \$GLL messages |
| <\$GLL msg> | String | NMEA \$GLL messages or "Not available" if the NMEA string is enabled, but this information has not been still sent to the user. |

24.3.11 Get number of GNSS satellites in view +UGGSV

| +UGGSV | | | | | | |
|-------------------|---|---------------------|-----------------------|-----------------------|----------------------|------------------------|
| Modules | SARA-R410M-02B SARA-R410M-52B SARA-R410M-63B SARA-R410M-73B SARA-R410M-83B SARA-R412M SARA-R422M8S SARA-R422S SARA-N4 | | | | | |
| Attributes | Syntax | PIN required | Settings saved | Can be aborted | Response time | Error reference |
| | full | No | NVM | No | < 10 s | +CME Error |

24.3.11.1 Description

Enable/disables the storing of the last value of NMEA \$GSM messages, and gets the current messaging state. If the <state> parameter is enabled, the last value of NMEA \$GSM messages can be retrieved with the read command even when the GNSS is switched off.

The NMEA \$GSM messages are volatile.

24.3.11.2 Syntax

| Type | Syntax | Response | Example |
|------|------------------|---|--|
| Set | AT+UGGSV=<state> | OK | AT+UGGSV=1 OK |
| Read | AT+UGGSV? | +UGGSV: <state>,<\$GSM msg> OK | +UGGSV: 1,\$GPGSV,3,1,11,03,67,298, 22,06,88,149,29,07,06,302,,08,05, 332,25*73 \$GPGSV,3,2,11,09,02,334,25,14,02, 141,,15,10,041,43,16,46,209,16*7D \$GPGSV,3,3,11,18,48,066,35,21,26,0 70,35,27,80,314,25*40 \$GLGSV,1,1,03,73,13,248,,74,23,298, 20,75,09,348,19*51 OK +UGGSV: 0,NULL OK |
| Test | AT+UGGSV=? | +UGGSV: (list of supported <state>s) OK | +UGGSV: (0-1) OK |

24.3.11.3 Defined values

| Parameter | Type | Description |
|-------------|--------|--|
| <state> | Number | <ul style="list-style-type: none"> 0 (factory-programmed value): to disable the NMEA \$GSM messages 1: to enable the NMEA \$GSM messages |
| <\$GSM msg> | String | NMEA \$GSM messages or "Not available" if the NMEA string is enabled, but this information has not been still sent to the user. |

24.3.11.4 Notes

- Since the \$GSM message reports satellite information, the output of the different GNSS systems is not combined, but it is reported in sequence as in the example above with GPS and GLONASS.

24.3.12 Get recommended minimum GNSS data +UGRMC

| +UGRMC | | | | | | |
|-------------------|---|---------------------|-----------------------|-----------------------|----------------------|------------------------|
| Modules | SARA-R410M-02B SARA-R410M-52B SARA-R410M-63B SARA-R410M-73B SARA-R410M-83B SARA-R412M SARA-R422M8S SARA-R422S SARA-N4 | | | | | |
| Attributes | Syntax | PIN required | Settings saved | Can be aborted | Response time | Error reference |
| | full | No | NVM | No | < 10 s | +CME Error |

24.3.12.1 Description

Enable/disables the storing of the last value of NMEA \$RMC messages, and gets the current messaging state. If the <state> parameter is enabled, the last value of NMEA \$RMC messages can be retrieved with the read command even when the GNSS is switched off.

The NMEA \$RMC messages are volatile.

24.3.12.2 Syntax

| Type | Syntax | Response | Example |
|------|------------------|---|---|
| Set | AT+UGRMC=<state> | OK | AT+UGRMC=1 OK |
| Read | AT+UGRMC? | +UGRMC: <state>,<\$RMC msg> OK | +UGRMC: 1,\$GPRMC,142351.00,V,,,, ,,,121213,,,N*7F OK +UGRMC: 0,NULL OK |
| Test | AT+UGRMC=? | +UGRMC: (list of supported <state>s) OK | +UGRMC: (0-1) OK |

24.3.12.3 Defined values

| Parameter | Type | Description |
|-------------|--------|--|
| <state> | Number | <ul style="list-style-type: none"> 0 (factory-programmed value): to disable the NMEA \$RMC messages 1: to enable the NMEA \$RMC messages |
| <\$RMC msg> | String | NMEA \$RMC messages or "Not available" if the NMEA string is enabled, but this information has not been still sent to the user. |

24.3.13 Get course over ground and ground speed +UGVTG

| +UGVTG | | | | | | |
|-------------------|---|---------------------|-----------------------|-----------------------|----------------------|------------------------|
| Modules | SARA-R410M-02B SARA-R410M-52B SARA-R410M-63B SARA-R410M-73B SARA-R410M-83B SARA-R412M SARA-R422M8S SARA-R422S SARA-N4 | | | | | |
| Attributes | Syntax | PIN required | Settings saved | Can be aborted | Response time | Error reference |
| | full | No | NVM | No | < 10 s | +CME Error |

24.3.13.1 Description

Enables/disables the storing of the last value of NMEA \$VTG messages, and gets know the current messaging state. If the <state> parameter is enabled, the last value of NMEA \$VTG messages can be retrieved with the read command even when the GNSS is switched off.

The NMEA \$VTG messages are volatile.

24.3.13.2 Syntax

| Type | Syntax | Response | Example |
|------|------------------|-----------------------------------|--------------------------------------|
| Set | AT+UGVTG=<state> | OK | AT+UGVTG=1 OK |
| Read | AT+UGVTG? | +UGVTG: <state>,<\$VTG msg> OK | +UGVTG: 1,\$GPVTG,,,,,,,,,N*30 OK |

| Type | Syntax | Response | Example |
|------|------------|--|----------------------|
| | | | +UGVTG: 0,NULL OK |
| Test | AT+UGVTG=? | +UGVTG: (list of supported <state>s) OK | +UGVTG: (0-1) OK |

24.3.13.3 Defined values

| Parameter | Type | Description |
|-------------|--------|--|
| <state> | Number | <ul style="list-style-type: none"> 0 (factory-programmed value): to disable the NMEA \$VTG messages 1: to enable the NMEA \$VTG messages |
| <\$VTG msg> | String | NMEA \$VTG messages or "Not available" if the NMEA string is enabled, but this information has not been still sent to the user. |

24.3.14 Get satellite information +UGGSA

| +UGGSA | | | | | | |
|------------|---|--------------|---------------------|----------------|---------------|----------------------------|
| Modules | SARA-R410M-02B SARA-R410M-52B SARA-R410M-63B SARA-R410M-73B SARA-R410M-83B SARA-R412M SARA-R422M8S SARA-R422S SARA-N4 | | | | | |
| Attributes | Syntax | PIN required | Settings saved | Can be aborted | Response time | Error reference |
| | full | No | NVM | No | < 10 s | +CME Error |

24.3.14.1 Description

Enables/disables the storing of the last value of NMEA \$GSA messages, and gets the current messaging state. If <state> parameter is enabled, the last value of NMEA \$GSA messages can be retrieved with the read command even when the GNSS is switched off.

The NMEA \$GSA messages are volatile.

24.3.14.2 Syntax

| Type | Syntax | Response | Example |
|------|------------------|--|--|
| Set | AT+UGGSA=<state> | OK | AT+UGGSA=1 OK |
| Read | AT+UGGSA? | +UGGSA: <state>,<\$GSA msg> OK | +UGGSA: 1,\$GPGSA,A,1,,,,,,,,,,,,,99.99,99.99,99.99*30 OK +UGGSA: 0,NULL OK |
| Test | AT+UGGSA=? | +UGGSA: (list of supported <state>s) OK | +UGGSA: (0-1) OK |

24.3.14.3 Defined values

| Parameter | Type | Description |
|-------------|--------|--|
| <state> | Number | <ul style="list-style-type: none"> 0 (factory-programmed value): to disable the NMEA \$GSA messages 1: to enable the NMEA \$GSA messages |
| <\$GSA msg> | String | NMEA \$GSA messages or "Not available" if the NMEA string is enabled, but this information has not been still sent to the user. |

24.4 CellLocate® and hybrid positioning

24.4.1 Ask for localization information +ULOC

| +ULOC | | | | | | |
|-------------------|---|---------------------|-----------------------|-----------------------|----------------------|------------------------|
| Modules | SARA-R410M-02B SARA-R410M-52B SARA-R410M-63B SARA-R410M-73B SARA-R410M-83B SARA-R412M SARA-R422M8S SARA-R422S SARA-N4 | | | | | |
| Attributes | Syntax | PIN required | Settings saved | Can be aborted | Response time | Error reference |
| | full | No | No | No | < 10 s | +CME Error |

24.4.1.1 Description









Requests cellular module to provide the location data; the location can be determined using:

- GNSS receiver
- CellLocate® (location based on network cells data)
- Combination of both technologies (hybrid)

The final result code indicates if sending the command request to the localization information process was successful or not. The URC is issued to provide the requested information via +ULOC set command.

In order to use simultaneously GNSS interface and CellLocate®, the GNSS shall not be a sensor for +ULOC: if the GNSS sensor is reserved to another interface (e.g. +UGPS) and is selected as a sensor also for +ULOC, an error result code is provided (" +CME ERROR: GPS busy" if +CMEE: 2).

It is possible to configure the hybrid positioning through +ULOCGNSS and +ULOCCELL AT commands even if it is running: the parameters are stored in NVM and will be applied at the next +ULOC command.

-  If the +ULOC command is sent while a previous +ULOC activity is still in progress the previous activity is aborted, the available position is immediately output and the next +ULOC request is served.
-  The data connection cannot be immediately dropped at the +ULOC timeout expiration. This could lead to a delay in the expected response time.
-  Depending on the aiding chosen, a data connection could be required; see the +UGPS AT command description.
-  If no position is available (no GNSS coverage, no network information and no previous data available) then the <lat> latitude and <long> longitude will be set to '0'.
-  If the previous position degraded by the elapsed time satisfies the desired accuracy then the sensor '0' is reported in the information text response.
-  If multi-hypothesis is required the GNSS solution and the CellLocate® solutions are reported, if available. If no GNSS or CellLocate® solutions are present, the previous position degraded is used instead.
-  If a valid GNSS fix with an accuracy below the required value (<accuracy>) occurs before the end of the network scan, the GNSS-only solution will be available, even if multi-hypothesis has been required.
-  SARA-R410M / SARA-R412M / SARA-R422M8S / SARA-R422S / SARA-N4
The location by means of CellLocate® requires an active data context: for more details, see +UPSD AT command for CID mapping and +CGACT for activating a PDP context.

24.4.1.2 Syntax

| Type | Syntax | Response | Example |
|------|---|--|--|
| Set | AT+ULOC=<mode>,<sensor>,<response_type>,<timeout>,<accuracy>[,<num_hypothesis>] | OK | AT+ULOC=2,3,0,120,1 OK |
| Read | AT+ULOC? | +ULOC: <mode>,<sensor>,<response_type>,<timeout>,<accuracy>,<num_hypothesis> OK | +ULOC: 2,3,1,0,20,0 OK |
| Test | AT+ULOC=? | +ULOC: (list of supported <mode>s), (list of supported <sensor>s), (list of supported <response_type>s), (list of supported <timeout>s), (list | +ULOC: (0-2),(0-3),(0-2),(1-999),(1-999999),(1-16) OK |

| Type | Syntax | Response | Example |
|------|--------|---|---|
| | | of supported <accuracy>s),(list of supported <num_hypothesis>s) | |
| | | OK | |
| URC | | If <response_type>=0: +UULOC: <date>,<time>,<lat>,<long>,<alt>,<uncertainty> | +UULOC: 13/04/2011,09:54:51.000,45.6334520,13.0618620,49,1 |
| | | If <response_type>=1: +UULOC: <date>,<time>,<lat>,<long>,<alt>,<uncertainty>,<speed>,<direction>,<vertical_acc>,<sensor_used>,<SV_used>,<antenna_status>,<jamming_status> | +UULOC: 25/09/2013,10:13:29.000,45.7140971,13.7409172,266,17,0,0,18,1,6,3,9 |
| | | If <response_type>=2, <sensor_used>= 1 and <num_hypothesis>= N: +UULOC: <sol>,<num>,<sensor_used>,<date>,<time>,<lat>,<long>,<alt>,<uncertainty>,<speed>,<direction>,<vertical_acc>,<SV_used>,<antenna_status>,<jamming_status> | +UULOC: 1,2,1,08/04/2015,09:02:32.000,45.7141652,13.7410666,266,47,0,0,40,3,0,0 |
| | | If <response_type>=2, <sensor_used> = 2 and <num_hypothesis>= N: +UULOC: <sol>,<num>,<sensor_used>,<date>,<time>,<lat>,<long>,<alt>,<lat50>,<long50>,<major50>,<minor50>,<orientation50>,<confidence50>[,<lat95>,<long95>,<major95>,<minor95>,<orientation95>,<confidence95>] | +UULOC: 2,2,2,08/04/2015,09:02:19.000,45.7140665,13.7411681,0,45.7240260,13.7511276,113,10,0,50,45.7240260,13.7511276,143,41,0,95 |
| | | If <response_type>=2, <sensor_used>= 0: +UULOC: <sol>,<num>,<sensor_used>,<date>,<time>,<lat>,<long>,<alt>,<uncertainty> | +UULOC: 1,1,0,08/04/2015,09:03:45.000,45.7140290,13.7410695,0,32 |

24.4.1.3 Defined values

| Parameter | Type | Description |
|------------------|--------|--|
| <mode> | Number | Allowed values: <ul style="list-style-type: none"> • 0: reserved • 1: reserved • 2: single shot position |
| <sensor> | Number | Sensor selection: it is possible to combine different sensors summing <sensor> values of the selected sensors: <ul style="list-style-type: none"> • 0: use the last fix in the internal database and stop the GNSS receiver • 1: use the GNSS receiver for localization • 2: use cellular CellLocate[®] location information |
| <response_type> | Number | Type of response: <ul style="list-style-type: none"> • 0: standard (single-hypothesis) response • 1: detailed (single-hypothesis) response • 2: multi-hypotheses response |
| <timeout> | Number | Timeout period in seconds (1 - 999) |
| <accuracy> | Number | Target accuracy in meters (1 - 999999) |
| <num_hypothesis> | Number | Maximum desired number of responses from CellLocate [®] (up to 16): multiple positions followed by their ellipsoidal uncertainties. This value has to be increased by 1 (GNSS solution) to get the maximum number of possible solutions. This optional parameter can be used only if <response_type>=2. The default value is 1. |

| Parameter | Type | Description |
|---------------------------------|--------|---|
| <date> | String | GPS date ⁸ (DD/MM/YY) of the estimated position |
| <time> | String | GPS time ⁸ (hh:mm:ss.sss) of the estimated position |
| <lat> | String | Estimated latitude, in degrees |
| <long> | String | Estimated longitude, in degrees |
| <alt> | Number | Estimated altitude, in meters ⁹ |
| <uncertainty> | Number | Estimated 50% confidence level error, in meters (0 - 20000000) |
| <speed> | Number | Speed over ground m/s ⁹ |
| <direction> | Number | Course over ground in degree (0 deg - 360 deg) ⁽⁹⁾ |
| <vertical_acc> | Number | Vertical accuracy, in meters ⁹ |
| <sensor_used> | Number | Sensor used for the position calculation |
| <SV_used> | Number | Number of satellite used to calculate the position ⁹ |
| <sol> | Number | Solution index (between 1 and <num>) |
| <num> | Number | Total number of the available hypotheses (less than or equal to <num_hypothesis>) |
| <lat50>/<lat95> | String | Estimated latitude (50/95% confidence levels), in degrees |
| <long50>/<long95> | String | Estimated longitude (50/95% confidence levels), in degrees |
| <major50>/<major95> | Number | Semi-major axis of the ellipse (50/95% confidence levels), in meters |
| <minor50>/<minor95> | Number | Semi-minor axis of the ellipse (50/95% confidence levels), in meters |
| <orientation50>/<orientation95> | Number | Orientation of the ellipse (50/95% confidence levels), in degrees |
| <confidence50>/<confidence95> | Number | 50/95% confidence levels, in percentage |
| <antenna_status> | Number | Antenna status (0 - 4) ⁽⁹⁾ . For more details, see the u-blox GNSS receiver protocol specification |
| <jamming_status> | Number | Jamming status ⁹ . For more details, see the u-blox GNSS receiver protocol specification |

24.4.1.4 Notes

- If AssistNow Online aiding data has been configured by means of the <aiding> parameter of **+ULOC** AT command, the +ULOC request using <sensor>=1 (GNSS receiver only) can provide a +UULOC URC reporting a CellLocate[®] solution (<sensor_used>=2). This can happen if:
 - a GNSS fix is not available.
 - the CellLocate[®] solution is more accurate (i.e. CellLocate[®] solution's uncertainty is better than the GNSS's one).
- If <sensor>=1 (use the GNSS receiver for localization), <response_type>=2 (multi-hypotheses response) is not supported.
- The <jamming_status> value must be ignored if the jamming is disabled through **+ULOC** command.
- The <date>, <time>, <lat>, <long> values are not enclosed in double quotes in the URC.

SARA-R410M-02B / SARA-R412M

- <sensor>=2 is not supported by SARA-R410M-02B-00, SARA-R410M-02B-01, SARA-R410M-02B-02, SARA-R412M-02B-00, SARA-R412M-02B-01, SARA-R412M-02B-02.

SARA-R410M-52B / SARA-N4

- <sensor>=2 is not supported.

⁸ Coming either from the CellLocate[®] server or the GNSS receiver (GPS time)

⁹ only for GNSS positioning, 0 in case of CellLocate[®]

24.4.2 Localization information request status unsolicited indication +ULOCIND

| +ULOCIND | | | | | | |
|-------------------|---|---------------------|-----------------------|-----------------------|----------------------|------------------------|
| Modules | SARA-R410M-02B SARA-R410M-52B SARA-R410M-63B SARA-R410M-73B SARA-R410M-83B SARA-R412M SARA-R422M8S SARA-R422S SARA-N4 | | | | | |
| Attributes | Syntax | PIN required | Settings saved | Can be aborted | Response time | Error reference |
| | full | No | NVM | No | - | +CME Error |

24.4.2.1 Description

Configures sending of URCs from MT to TE in the case of +ULOC operations. The URC provides the result of the steps of an +ULOC operation.

24.4.2.2 Syntax

| Type | Syntax | Response | Example |
|------|-------------------|---|-----------------------|
| Set | AT+ULOCIND=<mode> | OK | AT+ULOCIND=1 OK |
| Read | AT+ULOCIND? | +ULOCIND: <mode> OK | +ULOCIND: 1 OK |
| Test | AT+ULOCIND=? | +ULOCIND: (list of supported <mode>'s) OK | +ULOCIND: (0-1) OK |
| URC | | +ULOCIND: <step>,<result> OK | +ULOCIND: 1,0 OK |

24.4.2.3 Defined values

| Parameter | Type | Description |
|-----------|--------|--|
| <mode> | Number | URC configuration: <ul style="list-style-type: none"> 0 (default value): disabled 1: enabled |
| <step> | Number | Informs the user about the operation in progress: <ul style="list-style-type: none"> 0: network scan start 1: network scan end 2: requesting data to the server 3: received data from the server 4: sending feedback to the server |
| <result> | Number | Represents the result of the aiding operation: <ul style="list-style-type: none"> 0: no error 1: wrong URL 2: HTTP error 3: create socket error 4: close socket error 5: write to socket error 6: read from socket error 7: connection/DNS error 8: authentication token missing or wrong (required for aiding for u-blox M8 and future versions) 9: generic error 10: user terminated 11: no data from server |

24.4.2.4 Notes

SARA-R422M8S / SARA-R422S



- The command setting is not stored in the NVM.

24.4.3 Specify the device autonomous solution +UOCAID

| +UOCAID | | | | | | |
|-------------------|---|---------------------|-----------------------|-----------------------|----------------------|------------------------|
| Modules | SARA-R410M-02B SARA-R410M-63B SARA-R410M-73B SARA-R410M-83B SARA-R412M SARA-R422M8S SARA-R422S | | | | | |
| Attributes | Syntax | PIN required | Settings saved | Can be aborted | Response time | Error reference |
| | full | No | No | No | - | +CME Error |

24.4.3.1 Description

The user has the possibility to specify its state (position and velocity) at a given time to select one of the multi-hypothesis provided in the previous +ULOC request (<sol> parameter) or to insert a location estimate provided by other sensors. These information will be sent to the server with the next +ULOC command.

-  This command influences the amount of data exchanged with the server.
-  If the parameters of the autonomous solution have to be specified (<index> = 0), the RTC time must have a correct value prior to using the +UOCAID command.
-  Speed and direction parameters can be inserted (optionally) also if one of the multi-hypotheses has been selected (<index> > 0). Default values are those contained in the hypothesis selected (equal to 0 for CellLocate® solutions).

24.4.3.2 Syntax

| Type | Syntax | Response | Example |
|--|--|---|--|
| Location estimate from other sensors | | | |
| Set | AT+UOCAID=0,<date>,<time>, <lat>,<long>,<major>,<minor>, <orientation>[,<speed>,<direction>] | OK | AT+UOCAID=0,"10/03/2015", "11:37:32.000","45.23456","11.12345", 1300,789,34,34,121 OK |
| Read | AT+UOCAID? | +UOCAID: <index>,<date>,<time>, <lat>,<long>,<major>,<minor>, <orientation>[,<speed>,<direction>] OK | If <speed> and <direction> set: +UOCAID: 0,"10/03/2015", "11:37:32.000","45.23456","11.12345", 1300,789,34,34,121 OK If <speed> and <direction> unknown: +UOCAID: 0,"10/03/2015", "11:37:32.000","45.23456","11.12345", 1300,789,34 OK |
| Location estimate from hypothesis selected (<index> greater than 0) | | | |
| Set | AT+UOCAID=<index>[,,,,,,, <speed>,<direction>] | OK | If <speed> and <direction> unknown: AT+UOCAID=1 OK If <speed> and <direction> set: AT+UOCAID=1,,,,,,34,121 OK |
| Read | AT+UOCAID? | +UOCAID: <index>,<date>,<time>, <lat>,<long>,<major>,<minor>, <orientation>[,<speed>,<direction>] OK | If <speed> and <direction> unknown: +UOCAID: 1,"0/0/0","0:0:0.000","0.0 000000","0.000000",0,0,0 OK If <speed> and <direction> set: +UOCAID: 1,"0/0/0","0:0:0.000","0.0 000000","0.000000",0,34,121 OK |

| Type | Syntax | Response | Example |
|------|-------------|---|---|
| Test | AT+UOCAID=? | +UOCAID: (list of supported <index>s),(list of supported <date>s),(list of supported <time>),(list of supported <lat>),(list of supported <long>),(list of supported <major>),(list of supported <minor>),(list of supported <orientation>),(list of supported <speed>s),(list of supported <direction>s) OK | +UOCAID: (0-17),,,,,,(0-630000),(0-6300000),(0-179),(0-255),(0-359) OK |

24.4.3.3 Defined values

| Parameter | Type | Description |
|---------------|--------|--|
| <index> | Number | Multi-hypothesis index: <ul style="list-style-type: none"> 0: location estimate from other sensors (following fields are used) n: index of the previous CellLocate® solution |
| <date> | String | Date (DD/MM/YY) of the estimated position. |
| <time> | String | Time (hh:mm:ss.sss) of the estimated position. |
| <lat> | String | Estimated latitude expressed in degrees. |
| <long> | String | Estimated longitude expressed in degrees. |
| <major> | Number | Semi-major axis of the uncertainty ellipse in meters. |
| <minor> | Number | Semi-minor axis of the uncertainty ellipse in meters. |
| <orientation> | Number | Orientation of the semi-major axis of the ellipse in degrees. |
| <speed> | Number | Estimated speed in meters per second. Default value is 0. |
| <direction> | Number | Direction of the motion in degrees. Default value is 0. |

24.4.3.4 Notes

SARA-R410M-02B / SARA-R412M

- The command is not supported by SARA-R410M-02B-00, SARA-R410M-02B-01, SARA-R410M-02B-02, SARA-R412M-02B-00, SARA-R412M-02B-01, SARA-R412M-02B-02.

24.4.4 GNSS sensor configuration +ULOGNSS

| +ULOGNSS | | | | | | |
|-------------------|---|---------------------|-----------------------|-----------------------|----------------------|------------------------|
| Modules | SARA-R410M-02B SARA-R410M-52B SARA-R410M-63B SARA-R410M-73B SARA-R410M-83B SARA-R412M SARA-R422M8S SARA-R422S SARA-N4 | | | | | |
| Attributes | Syntax | PIN required | Settings saved | Can be aborted | Response time | Error reference |
| | full | No | NVM | No | - | +CME Error |

24.4.4.1 Description

Configures the GNSS sensor that can be used with the [+ULOC](#) AT command.

24.4.4.2 Syntax

| Type | Syntax | Response | Example |
|------|--|---|--|
| Set | AT+ULOGNSS=<aiding>[,<psv_mode>[,<minSV>[,<minCNO>[,<ini_3d_fix>[,<staticHoldMode>[,<SBAS>[,<jamming>[,<antenna>[,<BBthreshold>[,<CWthreshold>[,<GNSS_system>[,<reserved1>[,<reserved2>]]]]]]]]]]] | OK | AT+ULOGNSS=15 OK |
| Read | AT+ULOGNSS? | +ULOGNSS: <aiding>,<psv_mode>,<minSV>,<minCNO>,<ini_3d_fix>,<staticHoldMode>,<SBAS>,<jamming>,<antenna>,<BBthreshold>,<CWthreshold>,<GNSS_system>,<reserved1>,<reserved2> | +ULOGNSS: 15,1,6,8,0,1,1,1,1,1,0,0,0 OK |

| Type | Syntax | Response | Example |
|------|---------------|--|---|
| | | <GNSS_system>,<reserved1>,<reserved2> | |
| | | OK | |
| Test | AT+ULOGGNSS=? | +ULOGGNSS: (list of supported <aiding>),(list of supported <psv_mode>),(list of supported <minSV>),(list of supported <minCNO>),(list of supported <ini_3d_fix>),(list of supported <staticHoldMode>),(list of supported <SBAS>),(list of supported <jamming>),(list of supported <antenna>),(list of supported <BBthreshold>),(list of supported <CWthreshold>),(list of supported <GNSS_system>),(0),(0) | +ULOGGNSS: (0-15),(0-1),(3-32),(0-50),(0-1),(0-255),(0-1),(0-1),(0-2),(0-15),(0-31),(1-127),(0),(0) |
| | | OK | OK |
| | | OK | |

24.4.4.3 Defined values

| Parameter | Type | Description |
|------------------|--------|--|
| <aiding> | Number | GNSS aiding mode configuration; it is possible the combination of different aiding modes: to enable more aiding modes it is needed to sum the <mode> value of the interested aiding modes: <ul style="list-style-type: none"> • 1: local aiding (including RTC sharing) • 2: AssistNow Offline • 4: AssistNow Online • 8: AssistNow Autonomous All the modes (15) are enabled as a factory programmed setting. |
| <psv_mode> | Number | Power Save Mode (UBX-CFG-RXM): <ul style="list-style-type: none"> • 0 (factory-programmed value): disabled • 1: enabled |
| <minSV> | Number | <ul style="list-style-type: none"> • Minimum number of satellites for navigation (UBX-CFG-NAVX5). The range goes from 3 to 32. (factory-programmed value: 3) |
| <minCNO> | Number | <ul style="list-style-type: none"> • Minimum satellite signal level for navigation (UBX-CFG-NAVX5). The range goes from 0 to 50. (factory-programmed value: 7) |
| <ini_3d_fix> | Number | Initial Fix must be 3D flag (UBX-CFG-NAVX5): <ul style="list-style-type: none"> • 0 (factory-programmed value): disabled • 1: enabled |
| <staticHoldMode> | Number | Static Hold Mode (UBX-CFG-NAV5). The range goes from 0 to 255 cm/s. (factory-programmed value: 0). If the parameter is omitted, the Static Hold Mode threshold will not be configured to GNSS. |
| <SBAS> | Number | SBAS configuration: <ul style="list-style-type: none"> • 0 (factory-programmed value): disabled • 1: enabled |
| <jamming> | Number | Jamming indicator (UBX-CFG-ITFM): <ul style="list-style-type: none"> • 0 (factory-programmed value): disabled • 1: enabled |
| <antenna> | Number | Antenna setting: <ul style="list-style-type: none"> • 0 (factory-programmed value): unknown • 1: passive • 2: active |
| <BBthreshold> | Number | Broadband jamming detection threshold (dB) (UBX-CFG-ITFM). The range goes from 0 to 15. (factory-programmed value: 0) |
| <CWthreshold> | Number | Continuous wave jamming detection threshold (dB) (UBX-CFG-ITFM). The range goes from 0 to 31. (factory-programmed value: 0) |
| <GNSS_systems> | Number | Bitmask for combining the supported GNSS types; the parameter is optional and the allowed values can be combined together (e.g. 3 means GPS+SBAS): <ul style="list-style-type: none"> • 1 (factory-programmed value): GPS • 2: SBAS |

24.4.5.4 Notes

SARA-R4

- When the module is registered with a NB-IoT network, the <scan_mode> parameter setting is not effective and a normal scan is triggered.

SARA-R410M-02B / SARA-R412M

- The command is not supported by SARA-R410M-02B-00, SARA-R410M-02B-01, SARA-R410M-02B-02, SARA-R412M-02B-00, SARA-R412M-02B-01, SARA-R412M-02B-02.

25 I²C

25.1 Introduction

The I²C AT commands support communication with more than one connected device via one of the controllers, but require opening and closing a logical channel for each connected device. Only one logical channel at a time can be opened.

The availability and hardware description of the I²C interfaces are out of the scope of this document and are described in a separate document. Refer to the corresponding module System Integration Manual.

The procedure for communicating with two different devices is:

- Open the logical channel for device1 (with `AT+UI2CO`)
- Read/write to/from device1 (with `AT+UI2CR`, `AT+UI2CW` and `+UI2CREGR`)
- Close the logical channel for device1 (with `AT+UI2CC`)
- Open the logical channel for device2 (with `AT+UI2CO`)
- Read/write to/from device2 (with `AT+UI2CR`, `AT+UI2CW` and `+UI2CREGR`)
- Close the logical channel for device2 (with `AT+UI2CC`)

Once the controller has been configured, it is possible to start I²C communication (read/write) with I²C slave peripherals.

The I²C controllers available on the u-blox cellular modules work only in Master Mode so they can be connected to slave devices only.

In case of a controller/device malfunction, the command's response is only "ERROR".

25.2 I²C open logical channel +UI2CO

| +UI2CO | | | | | | |
|-------------------|---|---------------------|-----------------------|-----------------------|----------------------|------------------------|
| Modules | SARA-R410M-02B SARA-R410M-52B SARA-R410M-63B SARA-R410M-73B SARA-R410M-83B SARA-R412M SARA-R422 SARA-R422M8S SARA-R422S SARA-N4 | | | | | |
| Attributes | Syntax | PIN required | Settings saved | Can be aborted | Response time | Error reference |
| | full | No | No | No | - | +CME Error |

25.2.1 Description

Changes the hardware and logical configuration of the selected I²C controller.

It is only possible to configure the I²C controller in Master Mode.

This command selects:

- The controller available in the u-blox cellular module
- The bus mode type
- The bit rate
- The address size (7-10 bit address)
- The slave device address

Once the selected controller has been configured, a logical channel between it and the selected slave device is set up and there is no need to further specify it. All the following I²C write, read and close commands refer to the currently opened logical channel. It is not possible to use the I²C write, read and open commands for writing or reading to/from a different slave device without first closing the I²C logical channel.

25.2.2 Syntax

| Type | Syntax | Response | Example |
|------|--|----------|--|
| Set | <code>AT+UI2CO=<I2C_controller_number>,<bus_mode>,<bit_rate>,<device_address>,<address_width></code> | OK | <code>AT+UI2CO=1,0,0,0x42,0</code> OK |

| Type | Syntax | Response | Example |
|------|------------|--|---|
| Test | AT+UI2CO=? | +UI2CO: (list of supported <I2C_controller_number>s),(list of supported <bus_mode>s),(list of supported <bit_rate>),(<device_address> range),(list of supported <address_width>s) OK | +UI2CO: (1),(0-1),(0-1),(0x000-0x3FF),(0-1) OK |

25.2.3 Defined values

| Parameter | Type | Description |
|-------------------------|------------|--|
| <I2C_controller_number> | Number | I ² C HW controller to use: <ul style="list-style-type: none"> 1: controller 1 |
| <bus_mode> | Number | I ² C bus mode type: <ul style="list-style-type: none"> 0: Bus Mode Standard (0 - 100 kbaud) 1: Bus Mode Fast (0 - 400 kbaud) |
| <bit_rate> | Number | I ² C bit rate: <ul style="list-style-type: none"> 0: 100 kb/s 1: 400 kb/s |
| <device_address> | Hex number | Device address in HEX format <ul style="list-style-type: none"> SARA-R4 / SARA-N4 - The range goes from 0x00 to 0x7F. |
| <address_width> | Number | I ² C size of the controller address: <ul style="list-style-type: none"> 0: 7 bit address 1: 10 bit address |

25.3 I²C write to peripheral +UI2CW

| +UI2CW | | | | | | |
|-------------------|---|---------------------|-----------------------|-----------------------|----------------------|----------------------------|
| Modules | SARA-R410M-02B SARA-R410M-52B SARA-R410M-63B SARA-R410M-73B SARA-R410M-83B SARA-R412M SARA-R422 SARA-R422M8S SARA-R422S SARA-N4 | | | | | |
| Attributes | Syntax | PIN required | Settings saved | Can be aborted | Response time | Error reference |
| | full | No | No | No | - | +CME Error |

25.3.1 Description

Writes the HEX data to the I²C slave device of the current logical channel. The HEX data formats are without 0x prefix (see example).

25.3.2 Syntax

| Type | Syntax | Response | Example |
|------|---|--|---|
| Set | AT+UI2CW=<hex_data>,<nof_byte_to_write> | OK | AT+UI2CW="0011AABBCCDDEEFF", 8 OK |
| Test | AT+UI2CW=? | +UI2CW: (byte to write),(range of supported <nof_byte_to_write>) OK | +UI2CW: "data", (1-100) OK |

25.3.3 Defined values

| Parameter | Type | Description |
|----------------------|--------|--|
| <hex_data> | String | Hex data sequence without prefix 0x, enclosed in double quotes, to be written to the I ² C slave device |
| <nof_bytes_to_write> | Number | Number of byte to write to the slave I ² C device. Range: 1-100 |

25.4 I²C read from peripheral +UI2CR

| +UI2CR | | | | | | |
|-------------------|---|---------------------|-----------------------|-----------------------|----------------------|----------------------------|
| Modules | SARA-R410M-02B SARA-R410M-52B SARA-R410M-63B SARA-R410M-73B SARA-R410M-83B SARA-R412M SARA-R422 SARA-R422M8S SARA-R422S SARA-N4 | | | | | |
| Attributes | Syntax | PIN required | Settings saved | Can be aborted | Response time | Error reference |
| | full | No | No | No | - | +CME Error |

25.4.1 Description

Reads <nof_bytes_to_read> of data from the I²C slave device of the current logical channel and prints them in HEX format in separate rows.

25.4.2 Syntax

| Type | Syntax | Response | Example |
|------|------------------------------|---|---|
| Read | AT+UI2CR=<nof_bytes_to_read> | +UI2CR: <index_1>: <byte_1> [+UI2CR: <index_n>: <byte_n> [.]] OK | AT+UI2CR=3 +UI2CR: 0: 0xA3 +UI2CR: 1: 0x0F +UI2CR: 2: 0xDB OK |
| Test | AT+UI2CR=? | +UI2CR: (list of supported <nof_bytes_to_read>s) OK | +UI2CR: (1-100) OK |

25.4.3 Defined values

| Parameter | Type | Description |
|------------------------|--------|--|
| <nof_bytes_to_read> | Number | Number of bytes to read from the slave I ² C device: <ul style="list-style-type: none"> SARA-R4 / SARA-N4 - The range goes from 1 to 87. |
| <index1>,...,<index_n> | Number | Index of the byte being printed. |
| <byte_1>,...,<byte_n> | Number | n-th byte of the data, in hex mode (unquoted, prefixed by 0x). |

25.5 I²C read from peripheral register +UI2CREGR

| +UI2CREGR | | | | | | |
|-------------------|---|---------------------|-----------------------|-----------------------|----------------------|----------------------------|
| Modules | SARA-R410M-02B SARA-R410M-52B SARA-R410M-63B SARA-R410M-73B SARA-R410M-83B SARA-R412M SARA-R422 SARA-R422M8S SARA-R422S SARA-N4 | | | | | |
| Attributes | Syntax | PIN required | Settings saved | Can be aborted | Response time | Error reference |
| | full | No | No | No | - | +CME Error |

25.5.1 Description

Reads <nof_bytes_to_read> of data from the slave register of the I²C slave device of the current logical channel and prints them in HEX format in separate rows.

25.5.2 Syntax

| Type | Syntax | Response | Example |
|------|--|---|--|
| Read | AT+UI2CREGR=<register_address>,<nof_bytes_to_read> | +UI2CREGR: <index_1>: <byte_1> [+UI2CREGR: <index_n>: <byte_n> [.]] OK | AT+UI2CREGR=0x42,3 +UI2CREGR: 0: 0xA3 +UI2CREGR: 1: 0x0F +UI2CREGR: 2: 0xDB OK |

| Type | Syntax | Response | Example |
|------|---------------|---|--------------------------------------|
| Test | AT+UI2CREGR=? | +UI2CREGR: (list of supported <register_address>s),(list of supported <nof_bytes_to_read>s) OK | +UI2CREGR: (0x00-0xFF),(1-100) OK |

25.5.3 Defined values

| Parameter | Type | Description |
|------------------------|--------|--|
| <register_address> | Number | Device address in HEX format |
| <nof_bytes_to_read> | Number | Number of bytes to read from the slave I ² C register. <ul style="list-style-type: none"> SARA-R4 / SARA-N4 - The range goes from 1 to 75. |
| <index1>,...,<index_n> | Number | Index of the byte being printed. |
| <byte_1>,...,<byte_n> | Number | n-th byte of the data, in hex mode (unquoted, prefixed by 0x). |

25.6 I²C close logical channel +UI2CC

| +UI2CC | | | | | | |
|-------------------|---|---------------------|-----------------------|-----------------------|----------------------|----------------------------|
| Modules | SARA-R410M-02B SARA-R410M-52B SARA-R410M-63B SARA-R410M-73B SARA-R410M-83B SARA-R412M SARA-R422 SARA-R422M8S SARA-R422S SARA-N4 | | | | | |
| Attributes | Syntax | PIN required | Settings saved | Can be aborted | Response time | Error reference |
| | full | No | No | No | - | +CME Error |

25.6.1 Description

Closes the I²C logical channel being used.

The logical channel must be closed before opening a new one.

25.6.2 Syntax

| Type | Syntax | Response | Example |
|--------|------------|----------|----------------|
| Action | AT+UI2CC | OK | AT+UI2CC OK |
| Test | AT+UI2CC=? | OK | OK |

26 Networking



26.1 Configure port filtering for embedded applications

+UEMBPF

| +UEMBPF | | | | | | |
|-------------------|-----------------------------------|---------------------|-----------------------|-----------------------|----------------------|------------------------|
| Modules | SARA-R422 SARA-R422M8S SARA-R422S | | | | | |
| Attributes | Syntax | PIN required | Settings saved | Can be aborted | Response time | Error reference |
| | full | No | NVM | No | - | +CME Error |

26.1.1 Description

Enables/disables port filtering to allow IP data traffic from embedded applications when a dial-up connection is active. When enabled, the application will pick source port inside the configured range and the incoming traffic to those ports will be directed to embedded application instead of PPP DTE.

-  Each set command overwrites the previous configuration. Only one port range can be configured.
-  When set command with <mode>=0 is issued, the parameter <port_range> shall not be inserted otherwise the command will return an error result code.
-  If <mode>=0 is configured, the read command will not return any range, but only +UEMBPF: 0 as information text response.

26.1.2 Syntax

| Type | Syntax | Response | Example |
|------|---------------------------------|--------------------------------------|-------------------------------|
| Set | AT+UEMBPF=<mode>[,<port_range>] | OK | AT+UEMBPF=1,"6000-6200" OK |
| Read | AT+UEMBPF? | +UEMBPF: <mode>[,<port_range>] OK | +UEMBPF: 1,"6000-6200" OK |

26.1.3 Defined values

| Parameter | Type | Description |
|--------------|--------|--|
| <mode> | Number | Port filtering enable/disable: <ul style="list-style-type: none"> • 0 (factory-programmed value): disable. The configured range is removed. • 1: enable. The <port_range> parameter is mandatory |
| <port_range> | String | Dash-separated port range to be filtered, in format "max_port-min_port". The max_port and min_port value goes from 1 to 65535. |

26.1.4 Examples

| Command | Response | Description |
|-------------------------|------------------------------|--|
| AT+UEMBPF=1,"6000-6200" | OK | Enabled ports from 6000 to 6200 to be used by embedded IP application. |
| AT+UEMBPF? | +UEMBPF: 1,"6000-6200" OK | Read the configuration. |
| AT+UEMBPF=0 | OK | Disable port filtering and removes the previously-saved port range. |

27 Constrained Application Protocol (CoAP)

27.1 Introduction

The Constrained Application Protocol (CoAP) is a datagram-based client/server application protocol for devices on the constrained network (e.g. low overhead, low-power), designed to easily translate to HTTP for simplified integration with the web. CoAP clients can use the GET, PUT, POST and DELETE methods using requests and responses with a CoAP server.

The CoAP defines the application level Quality of Service (QoS), where requests and response messages may be marked as:

- **"Confirmable" (CON):** the messages must be acknowledged by the receiver if successfully received.
- **"Non-confirmable" (NON):** the messages are "fire and forget".

Supported components are:

- **CoAP-AT:** it can be used to send or receive messages (by means of **+UCOAPC** command) via CoAP.

27.2 CoAP profile configuration +UCOAP

| +UCOAP | | | | | | |
|-------------------|-------------------------|---------------------|-----------------------|-----------------------|----------------------|------------------------|
| Modules | SARA-R422M8S SARA-R422S | | | | | |
| Attributes | Syntax | PIN required | Settings saved | Can be aborted | Response time | Error reference |
| | full | No | NVM | No | - | +CME Error |

27.2.1 Description

Configures, reads and resets the current profile parameters of the CoAP client. A set command for each <op_code> parameter must be issued to set each CoAP client profile parameter (CoAP server address, CoAP URI, CoAP PDU option mask).

To store in the NVM the configured CoAP client profile parameters issue the AT+UCOAP=6,<profile_number> command where the <profile_number> parameter is the profile number.

To initiate a TCP session, instead of UDP session, in CoAP, provide the "coap+tcp" scheme by means of the <COAP_URI> parameter.

To initiate the secure session in CoAP, provide the "coaps" or "coaps+tcp" scheme by means of the <COAP_URI> parameter. Issue the AT+UCOAP=8,<USECMNG_profile> command to configure a CoAP secure session; the USECMNG profile number is set by means of the <USECMNG_profile> parameter.



SARA-R422M8S / SARA-R422S

Command AT+UCOAP=9,<rai_flag> can be configured but is not applicable on this product and it is not used in session configuration.

Up to four profiles can be stored in the NVM and only one can be loaded at a time. The loaded profile will be considered as the current profile and only this one can be stored in the NVM on the requested profile location.

The read command (AT+UCOAP=7) returns the parameter settings for all four profiles. If the profile is not defined, then the "+UCOAP: INVALID PROFILE NUMBER <profile_number>" will be returned in the information text response to the read command.



SARA-R422M8S / SARA-R422S

Parameter <COAP_server_IP_address> is not supported and can be provided as URI-HOST in <COAP_URI>.

27.2.2 Syntax

| Type | Syntax | Response | Example |
|-----------------------|---|----------|---|
| Generic syntax | | | |
| Set | AT+UCOAP=<op_code>,<param_val>[,<param_val1>] | OK | AT+UCOAP=1,"coap://10.17.4.27:3456/ublox/testuri?reference=0" OK |

| Type | Syntax | Response | Example |
|------------------------------------|---|---|---|
| Read | AT+UCOAP? | +UCOAP: <param_name>[,<param_val>] [.] +UCOAP: <param_name>[,<param_val>] OK | +UCOAP: "DST_IP_ADDRESS", "134.102.218.18" +UCOAP: "PORT",5683 +UCOAP: "URI_STR","coap:// coap.me/test" +UCOAP: "OPT_MASK",23 +UCOAP: "PROFILE_NUM",2 +UCOAP: "STATUS_FLAG",1 +UCOAP: "USECMNG_PROFILE" +UCOAP: "RAI_FLAG",0 OK |
| CoAP server IP address port | | | |
| Set | AT+UCOAP=0,<COAP_server_IP_address>[,<COAP_port>] | OK | AT+UCOAP=0,"192.168.10.25","2481" OK |
| CoAP URI | | | |
| Set | AT+UCOAP=1,<COAP_URI> | OK | AT+UCOAP=1,"coap://10 .17.4.27:3456/ublox/testuri? reference=0" OK |
| CoAP PDU option mask | | | |
| Set | AT+UCOAP=2,<PDU_option>[,<value>] | OK | AT+UCOAP=2,0,1 OK |
| Current profile number | | | |
| Set | AT+UCOAP=3,<profile_number> | OK | AT+UCOAP=3,0 OK |
| Current profile valid flag | | | |
| Set | AT+UCOAP=4,<valid_flag> | OK | AT+UCOAP=4,0 OK |
| Restore profile | | | |
| Set | AT+UCOAP=5,<profile_number> | OK | AT+UCOAP=5,0 OK |
| Store profile | | | |
| Set | AT+UCOAP=6,<profile_number> | OK | AT+UCOAP=6,0 OK |
| Read the stored profiles | | | |
| Read | AT+UCOAP=7 | +UCOAP: <param_name>,<param_val> [.] +UCOAP: <param_name>,<param_val> OK | AT+UCOAP=7 +UCOAP: INVALID PROFILE NUMBER 0 +UCOAP: INVALID PROFILE NUMBER 1 +UCOAP: "DST_IP_ADDRESS", "10 .56.9.34" +UCOAP: "PORT",3456 +UCOAP: "URI_STR","coap://10 .56.9.34:3456/ublox/testuri" +UCOAP: "OPT_MASK",7 +UCOAP: "PROFILE_NUM",2 +UCOAP: "STATUS_FLAG",1 +UCOAP: "USECMNG_PROFILE" +UCOAP: "RAI_FLAG",0 |

| Type | Syntax | Response | Example |
|-------------------------------|------------------------------|--|--|
| | | | +UCOAP: INVALID PROFILE NUMBER 3 OK |
| Select USECMNG profile | | | |
| Set | AT+UCOAP=8,<USECMNG_profile> | OK | AT+UCOAP=8,0 OK |
| RAI configuration | | | |
| Set | AT+UCOAP=9,<rai_flag> | OK | AT+UCOAP=9,0 OK |
| Test | AT+UCOAP=? | +UCOAP: (list of supported <op_code>s) OK | +UCOAP: (0-9) OK |

27.2.3 Defined values

| Parameter | Type | Description |
|--------------------------|--------|--|
| <op_code> | Number | Specific parameter in profile. Allowed values are: <ul style="list-style-type: none"> 0: CoAP server address configuration 1: CoAP URI configuration 2: CoAP PDU option mask configuration 3: current profile number 4: current profile valid 5: restore profile from the NVM 6: store profile to the NVM 7: read all profiles from the NVM 8: CoAP secure option (SSL encryption) 9: release assistance indication (RAI) |
| <COAP_server_IP_address> | String | Remote CoAP server IP address in IPv4 format. For IP address format reference see the IP addressing . |
| <COAP_port> | String | Remote CoAP server port; the default CoAP port is 5683, in case of secure option the default port is 5684. |
| <COAP_URI> | String | URI scheme supported are: <ul style="list-style-type: none"> UDP connection: "coap://"URI_HOST[":"URI_PORT] [URI_PATH] ["?"URI_QUERY] DTLS connection: "coaps://"URI_HOST[":"URI_PORT] [URI_PATH] ["?"URI_QUERY]  SARA-R422M8S / SARA-R422S Optional URI scheme (RFC 8323 [180]) supported are: <ul style="list-style-type: none"> TCP connection: "coap+tcp://"URI_HOST[":"URI_PORT] [URI_PATH] ["?"URI_QUERY] TLS connection: "coaps+tcp://"URI_HOST[":"URI_PORT] [URI_PATH] ["?"URI_QUERY] URI limitations are: <ul style="list-style-type: none"> SARA-R422M8S / SARA-R422S - The maximum supported length of the URI is 783 characters, where URI_HOST, URI_PATH and URI_QUERY options are limited to 255 characters each as per RFC 7252 [179]. |
| <PDU_option> | Number | PDU option to be added in PDU header. Allowed values are: <ul style="list-style-type: none"> 0: URI_HOST 1: URI_PORT 2: URI_PATH 3: URI_QUERY 4: CONTENT_FORMAT (CONTENT_FORMAT option in the PDU by means of the +UCOAPC AT command) 5: NON_Message. If it is enabled (see the <value> parameter) then the message type will be non-confirmable, otherwise it will be confirmable |
| <value> | Number | Allowed values are: <ul style="list-style-type: none"> 0 (default value): clear the corresponding option flag 1: set the corresponding option flag |
| <profile_number> | Number | Profile number to be used: |

| Parameter | Type | Description |
|-------------------|-------------------|---|
| | | <ul style="list-style-type: none"> 0: profile 0 1: profile 1 2: profile 2 3: profile 3 |
| <valid_flag> | Number | Sets the current profile as valid or invalid: <ul style="list-style-type: none"> 0: invalid profile 1: valid profile |
| <USECMNG_profile> | Number | Defines the USECMNG profile which specifies the SSL/TLS properties to be used for an SSL/TLS connection. The range goes from 0 to 4. If no profile is set a default USECMNG profile is used |
| <rai_flag> | Number | Sets the RAI flag. Allowed values: <ul style="list-style-type: none"> 0: RAI disabled 1: release the connection after the uplink data is sent. It can not be selected with confirmable message type. 2: release the connection after the first data is received in downlink. It can not be selected with non-confirmable message type. |
| <param_name> | String | Verbose description for the specific parameter, provided with their numeric values for each profile. Supported values: <ul style="list-style-type: none"> "DST_IP_ADDRESS" "PORT" "URI_STR" "OPT_MASK" "PROFILE_NUM" "STATUS FLAG" "USECMNG PROFILE" "RAI FLAG" |
| <param_val> | String/ Number | Type and supported content depend on the related <op_code> parameter; details are given above. |
| <param_val1> | String/ Number | Optional parameter; type and supported content depend on the related <op_code> parameter; details are given above. |

27.2.4 Notes

- No profiles are defined by factory-programmed setting.

SARA-R422M8S / SARA-R422S

- <op_code>=0 (CoAP server address configuration) is not supported.
- The <COAP_server_IP_address> and <COAP_port> parameters are not returned while reading CoAP profile.
- The RAI flag can be configured by means of the AT+UCOAP=9,<rai_flag> AT command but is not applicable and it is not used in session configuration.

27.3 CoAP command +UCOAPC

| +UCOAPC | | | | | | |
|------------|-------------------------|--------------|----------------|----------------|---------------|----------------------------|
| Modules | SARA-R422M8S SARA-R422S | | | | | |
| Attributes | Syntax | PIN required | Settings saved | Can be aborted | Response time | Error reference |
| | partial | No | No | No | - | +CME Error |

27.3.1 Description

Triggers the CoAP action with the <coap_command> parameter:

- GET request:** it can be used to get the requested payload. If the payload is larger than the maximum limit (the limit is imposed by the server), the block-wise transfer will be triggered automatically (if supported by the server);
- PUT or POST requests:** this can be used to send some payload. If the payload is larger than 512 bytes, then it can be sent via block-wise transfer by dividing the payload in blocks up to 512 bytes.

The final result code indicates if sending the command request to the CoAP process was successful or not. The +UCOAPCR (CoAP command result) URC returns to the user the final result of the CoAP command previously

sent with +UCOAPC. As well, the +UCOAPCD CoAP unsolicited data URC provides the data requested by the user and received from the CoAP server.

 The payload size in downlink is dependent upon the data packeting scheme of the CoAP server.

 For more details, see the RFC 7252 [179].

27.3.2 Syntax

| Type | Syntax | Response | Example |
|------|---|--|------------------------------|
| Set | AT+UCOAPC=<coap_command>[,<payload>,<identifier>[,<block_number>,<more_block>]] | OK | AT+UCOAPC=1 OK |
| Test | AT+UCOAPC=? | +UCOAPC: (list of supported <coap_command>s) OK | +UCOAPC: (1,4) OK |
| URC | | +UCOAPCD: <response_code>,[<identifier>],[<payload>],<more_block>[,<block_number>,<block_size>][,<urc_left>] | +UCOAPCD: 2,0,"34746E5F31",0 |
| URC | | +UCOAPCR: <coap_command>,<coap_result> | +UCOAPCR: 2,1 |

27.3.3 Defined values

| Parameter | Type | Description |
|-----------------|--------|--|
| <coap_command> | Number | CoAP action. Allowed values: <ul style="list-style-type: none"> • 1: GET request to the CoAP server; optional parameters are not allowed • 2: DELETE request to the CoAP server; optional parameters are not allowed • 3: PUT request to the CoAP server • 4: POST request to the CoAP server |
| <payload> | String | Hexadecimal payload to be sent or received. The maximum size in uplink is 512 bytes. For PUT (<coap_command>=3) and POST (<coap_command>=4) commands, if <more_block>=1 (more blocks available), allowed length values for payload are 8, 16, 32, 64, 128, 256, 512 bytes. For more details, see RFC 7959 [183]. |
| <identifier> | Number | CoAP Content-Type identifier. Allowed values: <ul style="list-style-type: none"> • 0: text / plain • 1: application / link format • 2: application / xml • 3: application / octet stream • 4: application / rdf xml • 5: application / exi • 6: application / json • 7: application / cbor |
| <block_number> | Number | Indicates the block number being requested or provided, starting from 0. |
| <more_block> | Number | Indicates that the data in the message is the last block or more blocks are available: <ul style="list-style-type: none"> • 0: last block • 1: more blocks available |
| <response_code> | Number | Numeric code added in the response from the server. Allowed values: <ul style="list-style-type: none"> • 0: empty message • 2: success • 4: client error • 5: server error |
| <block_size> | Number | Size of data to be acknowledged by the server. The maximum size in uplink is 512 bytes. |
| <urc_left> | Number | Indicates the number of remaining URCs that will be displayed for a data block, when the payload is too long to be displayed in a single URC and therefore it is split in multiple URCs. |
| <coap_result> | Number | Indicates the result of last CoAP command: <ul style="list-style-type: none"> • 0: fail • 1: success |

27.3.4 Notes

SARA-R422M8S / SARA-R422S

- In case of secure session (i.e. "coaps" or "coaps+tcp" URI scheme), the +UCOAPC command returns the OK final result code only when the secure session handshake is completed successfully.
- The time to establish the secure session (i.e. "coaps" or "coaps+tcp" URI scheme and +UCOAP: 8, <USECMNG_profile>) could require up to 150 s in one of these cases:
 - RoT generated PSK (+USECPRF: <profile_id>,11)
 - encrypted session resumption (+USECPRF: <profile_id>,13,2,10)

This is due to "security heartbeat" message operation. For more details on when this scenario occurs, see the +USECCONN AT command.

27.4 CoAP error reporting +UCOAPER

| +UCOAPER | | | | | | |
|-------------------|-------------------------|---------------------|-----------------------|-----------------------|----------------------|----------------------------|
| Modules | SARA-R422M8S SARA-R422S | | | | | |
| Attributes | Syntax | PIN required | Settings saved | Can be aborted | Response time | Error reference |
| | full | No | No | No | - | +CME Error Appendix A.7 |

27.4.1 Description

Returns the error code of the latest CoAP operation.

27.4.2 Syntax

| Type | Syntax | Response | Example |
|--------|------------|--|------------------------------------|
| Action | AT+UCOAPER | +UCOAPER: <error_class>,<error_code> OK | AT+UCOAPER +UCOAPER: 15,4 OK |

27.4.3 Defined values

| Parameter | Type | Description |
|---------------|--------|---|
| <error_class> | Number | List of the allowed values is available in listed in Appendix A.7 . |
| <error_code> | Number | Value of CoAP specific error code, the allowed <error_code> values are listed in Appendix A.7.6 . |

28 MQTT

28.1 Introduction

MQTT AT commands are implemented according with MQTT version 3.1.1. For a more detailed overview on MQTT protocol, see MQTT version 3.1.1 - OASIS standard [199].

The Message Queueing Telemetry Transport (MQTT) protocol specifies a simple and lightweight messaging protocol, designed for constrained devices and low-bandwidth, high-latency, or unreliable networks. An MQTT client uses publish and subscribe methods to interact over a TCP connection with an MQTT message broker (henceforth referred to as an MQTT server). The u-blox modules can be configured to operate as an MQTT client.

To publish or subscribe, the MQTT client must first establish a TCP connection to an MQTT server.

The MQTT protocol specifies case-sensitive topics, with topic names containing topic level separators "/" to which messages will be published. For example, a message of "78 Fahrenheit or 25 Celsius" could be published to the topic name of "/heat/sensor/SD/bldg5/DelMarConfRm". MQTT clients subscribe to topic filters to determine if the client receives messages published to a given topic name.

The topic filters may exactly specify a topic name or may contain either of the following wildcards:

- '+' - (single level wildcard) applies to a single topic level;
- '#' - (multi-level wildcard) applies to potentially many topic levels (and must be the last character specified in a topic filter).

'#' can be specified on its own or following a topic level separator ('/'). For example, the topic filter, "/heat/sensor/SD/#", would receive any messages published to the "/heat/sensor/SD/bldg5/DelMarConfRm" topic name.

MQTT specification states that topic filters starting with either wildcard will not match any topic name that starts with "\$".

The MQTT protocol also specifies a Quality of Service (QoS) level to be applied to message transactions:

- 0 (default setting): at most once delivery
- 1: at least once delivery
- 2: exactly once delivery

The MQTT protocol also allows an MQTT client to create a will message, which the MQTT remote server will store and only publish (to the topic name specified as the will topic name) when the MQTT client gets disconnected from the MQTT server, but not if the MQTT client explicitly sends a disconnect command.

A PSD connection must be activated before using MQTT AT commands.

SARA-R410M / SARA-R412M / SARA-R422M8S / SARA-R422S / SARA-N4
See +UPSD for CID mapping and +CGACT for activating a PDP context.

28.2 MQTT profile configuration +UMQTT

| +UMQTT | | | | | | |
|-------------------|---|---------------------|-----------------------|-----------------------|----------------------|------------------------|
| Modules | SARA-R410M-02B SARA-R410M-52B SARA-R410M-63B SARA-R410M-73B SARA-R410M-83B SARA-R412M SARA-R422M8S SARA-R422S SARA-N4 | | | | | |
| Attributes | Syntax | PIN required | Settings saved | Can be aborted | Response time | Error reference |
| | partial | No | +UMQTTNV | No | - | +CME Error |

28.2.1 Description

Configures or reads the parameter value of an MQTT client profile. Issue a set command for each <op_code> parameter to set all of the parameters in an MQTT client profile.

SARA-R410M / SARA-R412M / SARA-N4
The information text response to the read command provides a continuation string, **(more)**, if more information remains to be displayed. By issuing again the read command, the MQTT will attempt to continue the previous display attempt.

28.2.2 Syntax

| Type | Syntax | Response | Example |
|---|---|----------------------------------|--|
| Generic syntax | | | |
| Set | AT+UMQTT=<op_code>[,<param1>[,<param2>]] | +UMQTT: <op_code>,<result> OK | AT+UMQTT=12,1 +UMQTT: 12,1 OK |
| MQTT unique client ID | | | |
| Set | AT+UMQTT=0,<client_id> | +UMQTT: 0,<result> OK | AT+UMQTT=0,"352753090041680" +UMQTT: 0,1 OK |
| MQTT local TCP port number | | | |
| Set | AT+UMQTT=1,<local_port> | +UMQTT: 1,<result> OK | AT+UMQTT=1,1883 +UMQTT: 1,1 OK |
| MQTT server name | | | |
| Set | AT+UMQTT=2,<server_name>[,<server_port>] | +UMQTT: 2,<result> OK | AT+UMQTT=2, "www.commercialmqttbroker.com" +UMQTT: 2,1 OK |
| MQTT server IP address | | | |
| Set | AT+UMQTT=3,<IP_address>[,<server_port>] | +UMQTT: 3,<result> OK | AT+UMQTT=3,"192.168.1.0",1883 +UMQTT: 3,1 OK |
| User name and password | | | |
| Set | AT+UMQTT=4,<username>,<password> | +UMQTT: 4,<result> OK | AT+UMQTT=4,"test","abc123" +UMQTT: 4,1 OK |
| Last will QoS | | | |
| Set | AT+UMQTT=6,<will_QoS> | OK | AT+UMQTT=6,1 OK |
| Last will retain | | | |
| Set | AT+UMQTT=7,<will_retain> | OK | AT+UMQTT=7,1 OK |
| Last will topic | | | |
| Set | AT+UMQTT=8,<will_topic> | OK | AT+UMQTT=8,"u-blox/publish" OK |
| Last will message | | | |
| Set | AT+UMQTT=9,<will_message>[,<hex_mode>] | OK | AT+UMQTT=9,"Unrequested disconnect" OK |
| Inactivity timeout and linger time | | | |
| Set | AT+UMQTT=10,<timeout>[,<linger_time>] | +UMQTT: 10,<result> OK | AT+UMQTT=10,3600,20 +UMQTT: 10,1 OK |
| MQTT secure option | | | |
| Set | AT+UMQTT=11,<MQTT_secure>[,<USECMNG_profile>] | +UMQTT: 11,<result> OK | AT+UMQTT=11,1,2 +UMQTT: 11,1 OK |
| MQTT clean session | | | |
| Set | AT+UMQTT=12,<clean_session> | +UMQTT: 12,<result> OK | AT+UMQTT=12,1 +UMQTT: 12,1 |

| Type | Syntax | Response | Example |
|------|--------------------|--|--|
| | | | OK |
| Read | AT+UMQTT=<op_code> | +UMQTT: <op_code>,<param1>[,<param2>] OK | +UMQTT: 4,"my_username" OK |
| Read | AT+UMQTT? | +UMQTT: 0,<client_id> +UMQTT: 2,<server_name>,<server_port> +UMQTT: 3,IP_address>,<server_port> +UMQTT: 4,<username> +UMQTT: 6,<will_QoS> +UMQTT: 7,<will_retain> +UMQTT: 8,<will_topic> +UMQTT: 9,<wm_length>,<will_message> +UMQTT: 10,<timeout>,<linger_time> +UMQTT: 11,<MQTT_secure>[,<USECMNG_profile>] OK | +UMQTT: 0,"352848080012186" +UMQTT: 2,"",1883 +UMQTT: 3,"",1883 +UMQTT: 4,"" +UMQTT: 6,0 +UMQTT: 7,0 +UMQTT: 8,"" +UMQTT: 9,0,"" +UMQTT: 10,0,10 +UMQTT: 11,0 OK |
| Test | AT+UMQTT=? | +UMQTT: (list of supported <op_code>s) OK | +UMQTT: (0-4,10-12) OK |
| URC | | +UUMQTT<op_code>: <param1>[,<param2>] | +UUMQTT0: "352753090041680" |

28.2.3 Defined values

| Parameter | Type | Description |
|-------------|--------|--|
| <op_code> | Number | MQTT parameter: <ul style="list-style-type: none"> 0: MQTT unique client id 1: MQTT local port number 2: MQTT server name 3: MQTT IP address 4: MQTT username and password 6: MQTT last will QoS value 7: MQTT last will retain 8: MQTT last will topic 9: MQTT last will message 10: MQTT inactivity timeout period and linger time 11: MQTT secure 12: MQTT clean session 14: MQTT terse/verbose mode; the set command is not supported Allowed values: <ul style="list-style-type: none"> SARA-R422M8S / SARA-R422S - 0, 2, 3, 4, 6, 7, 8, 9, 10, 11 SARA-R410M-63B / SARA-R410M-73B / SARA-R410M-83B - 0, 2, 3, 4, 10, 11 SARA-R410M-02B / SARA-R410M-52B / SARA-R412M / SARA-N4 - 0, 1, 2, 3, 4, 10, 11, 12, 14 |
| <result> | Number | Allowed values: <ul style="list-style-type: none"> 0: failure 1: success |
| <client_id> | String | Client identifier for the MQTT session. <ul style="list-style-type: none"> SARA-R410M-63B / SARA-R410M-73B / SARA-R410M-83B / SARA-R422M8S / SARA-R422S - The maximum length is 256 characters. SARA-R410M-02B / SARA-R412M - The maximum length is 128 characters. |

| Parameter | Type | Description |
|----------------|--------|---|
| | | <ul style="list-style-type: none"> SARA-R410M-52B / SARA-N4 - The maximum length is 23 characters. <p>The default value is the IMEI of the MT.</p> <p> SARA-R410M-63B / SARA-R410M-73B / SARA-R410M-83B On SARA-R410M-63B-00, SARA-R410M-73B-00, SARA-R410M-83B-00 the maximum length of the <client_id> parameter is 23 characters.</p> <p> SARA-R410M-02B / SARA-R412M On SARA-R410M-02B-00, SARA-R410M-02B-01, SARA-R410M-02B-02, SARA-R412M-02B-00, SARA-R412M-02B-01, SARA-R412M-02B-02 the maximum length of the <client_id> parameter is 23 characters.</p> |
| <local_port> | Number | MQTT client TCP port. The range goes from 1 to 65535. If the MQTT client port number is not specified, the default port number is the IANA assigned port of 1883 for non-TLS MQTT and 8883 for TLS MQTT. |
| <server_name> | String | Remote server name. <ul style="list-style-type: none"> SARA-R410M-02B / SARA-R410M-52B / SARA-R412M / SARA-R422M8S / SARA-R422S / SARA-N4 - The maximum length is 128 characters. SARA-R410M-63B / SARA-R410M-73B / SARA-R410M-83B - The maximum length is 512 characters. <p>The default value is an empty string.</p> |
| <IP_address> | String | Remote server IP address. The default value is an empty string. For IP address format reference, see the IP addressing . |
| <server_port> | Number | MQTT server port. The range goes from 1 to 65535. The default value is 1883 for non-TLS MQTT, 8883 for TLS MQTT. <ul style="list-style-type: none"> SARA-R422M8S / SARA-R422S - the set command also accepts 0: it is used to automatically reset the <server_port> to the default value (1883 or 8883). |
| <username> | String | User name for the MQTT login procedure. The default value is an empty string: <ul style="list-style-type: none"> SARA-R410M-63B / SARA-R410M-73B / SARA-R410M-83B / SARA-R422M8S / SARA-R422S - The maximum length is 512 characters. SARA-R410M-02B / SARA-R410M-52B / SARA-R412M / SARA-N4 - The maximum length is 30 characters. |
| <password> | String | Password for the MQTT login procedure. The default value is an empty string: <ul style="list-style-type: none"> SARA-R410M-63B / SARA-R410M-73B / SARA-R410M-83B / SARA-R422M8S / SARA-R422S - The maximum length is 512 characters. SARA-R410M-02B / SARA-R410M-52B / SARA-R412M / SARA-N4 - The maximum length is 30 characters. |
| <timeout> | Number | Inactivity timeout expressed in seconds. According to the MQTT specification, an MQTT server must disconnect a client if it receives nothing from the client within 1.5x the inactivity timeout. An inactivity timeout value of 0 indicates no timeout. The default value is 0. The maximum value is 65535 (corresponding to 18 hours, 12 minutes and 15 seconds). |
| <linger_time> | Number | Linger time expressed in seconds. The range goes from 0 to 120 s; 0 means linger time is not set. The default value is 10 s. |
| <will_QoS> | Number | MQTT last will Quality of Service: <ul style="list-style-type: none"> 0 (default value): at most once delivery 1: at least once delivery 2: exactly once delivery |
| <will_retain> | Number | Whether or not the last will message will be retained across disconnects: <ul style="list-style-type: none"> 0 (default value): the last will message will not be retained by the MQTT broker 1: the last will message will be retained by the MQTT broker |
| <will_topic> | String | Last will topic name. The default value is an empty string. <ul style="list-style-type: none"> SARA-R4 / SARA-N4 - The maximum length is 256 characters. |
| <will_message> | String | Last will message: ASCII or hexadecimal data. <ul style="list-style-type: none"> SARA-R422M8S / SARA-R422S - The maximum length is 256 characters. In case of hexadecimal data the parameter length must be even. |
| <hex_mode> | Number | Allowed values: <ul style="list-style-type: none"> 0 (default value): ASCII input for <will_message> 1: hexadecimal input for <will_message> |
| <wm_length> | Number | Number of octets in <will_message>. |
| <MQTT_secure> | Number | Enables / disables the secure option of MQTT service: <ul style="list-style-type: none"> 0 (default value): no TLS encryption 1: enable the MQTT TLS encryption |

| Parameter | Type | Description |
|-------------------|-----------------|---|
| <USECMNG_profile> | Number | USECMNG profile (number). Defines the USECMNG profile which specifies the SSL/TLS properties to be used for the SSL/TLS connection. The range goes from 0 to 4. If no profile is set a default USECMNG profile is used (see +USECMNG AT command description). |
| <clean_session> | Number | Clean session value. Allowed values: <ul style="list-style-type: none"> 0: indicates that the client subscription and delivered messages received by the client should be remembered across disconnects by both the MQTT client and the MQTT server 1: (default value) indicates that disconnects clean all session state information |
| <param1> | Number / String | Type and supported content depend on the related <op_code> parameter (details are given above). If <param1> is not specified the value of the corresponding parameter <op_code> is reset to the default value. |
| <param2> | Number / String | Type and supported content depend on the related <op_code> parameter (details are given above). If <param2> is not specified the value of the corresponding parameter <op_code> is reset to the default value. |

28.2.4 Notes

- The information text response to the read command does not display the password.
- Some network operators do not allow secure MQTT. In this case the [AT+UMQTTC=1](#) command (MQTT login) will return a failure response by means of the [+UUMQTT](#) URC after an TLS timeout of 30 s.

SARA-R422M8S / SARA-R422S

- The set command does not provide the [+UMQTT](#): <op_code>,<result> information text response: only the final result code is issued.
- The [+UUMQTT](#) URC is not supported.
- The MQTT session is always cleaned on disconnection.
- See the [Appendix A.1](#) for the allowed error result codes.
- <op_code>=2 (MQTT server name) and <op_code>=3 (MQTT IP address) are equivalent, when broker connection is established the server name is transformed into the IP address.

SARA-R410M / SARA-R412M / SARA-N4

- For individual MQTT parameter fields, especially the string fields (double-quote delimited), the continuation symbol + indicates whether the current display is a continuation from a previous display or whether the current display has more information to be displayed.
- If the continuation symbol precedes the first double-quote, e.g., **Topic: +"is continuing from previous display"**, then this MQTT parameter field continues from a previous display command. If the continuation symbol trails the last double-quote, e.g., **Topic: "This message won't fit within the limita"+**, then it indicates that more information from this MQTT parameter remains to be displayed. If the continuation symbol appears on both sides of the double-quotes, then this message is the continuation of a previous display (and requires future displays to complete), e.g., **Topic: +"is in the middle of a long messa"+**.
- When displaying all of the MQTT client profile parameters, ([AT+UMQTT?](#)), only the non-default string parameters are displayed. Thus, if will message, will topic, server name, IP address, username, or password are not entered, they will not be displayed.
- Only IPv4 is supported.
- Client subscriptions and delivered messages across disconnects by either the server or the client <clean_session>=0 is not supported.
- <op_code>=2 (MQTT server name) and <op_code>=3 (MQTT IP address) are equivalent, when broker connection is established the server name is transformed into the IP address.
- After logout ([AT+UMQTTC=0](#)), MQTT settings need to be re-set individually or restored from the NVM with the [AT+UMQTTNV=1](#) command to login again.
- If <op_code>=11 (MQTT secure) and <MQTT_secure>=1 (MQTT TLS encryption enabled), the <USECMNG_profile> parameter is mandatory.
- The <linger_time> is not supported.

SARA-R410M-63B / SARA-R410M-73B / SARA-R410M-83B

- The [+UUMQTT](#) URC is not supported.
- On SARA-R410M-63B-00, SARA-R410M-73B-00, SARA-R410M-83B-00 the maximum length of the <client_id> parameter is 23 characters.

SARA-R410M-02B / SARA-R410M-52B / SARA-R412M / SARA-N4

- The profile parameters MQTT will QoS value (<op_code>=6), MQTT will retain (<op_code>=7), MQTT will topic (<op_code>=8), MQTT will message (<op_code>=9) and MQTT terse/verbose mode (<op_code>=14) are provided in the read response for informational purposes. They cannot be set using the +UMQTT set command:
 - The MQTT will QoS value (<op_code>=6), MQTT will retain (<op_code>=7) and MQTT will topic (<op_code>=8) are set with the **+UMQTTWTOPIC** AT command.
 - The MQTT will message (<op_code>=9) is set with the **+UMQTTWMSG** AT command.
 - The MQTT terse/verbose mode (<op_code>=14) is set with the **+UMQTTTC** AT command.

SARA-R410M-02B

- The secure MQTT (TLS) (<op_code>=11) is not supported by SARA-R410M-02B-00.

28.3 MQTT will topic configuration +UMQTTWTOPIC

| +UMQTTWTOPIC | | | | | | |
|---------------------|---|---------------------|-----------------------|-----------------------|----------------------|------------------------|
| Modules | SARA-R410M-02B SARA-R410M-52B SARA-R410M-63B SARA-R410M-73B SARA-R410M-83B SARA-R412M SARA-N4 | | | | | |
| Attributes | Syntax | PIN required | Settings saved | Can be aborted | Response time | Error reference |
| | partial | No | No | No | - | +CME Error |

28.3.1 Description

Configures the MQTT profile parameters related to the MQTT's will message ("Last Will and Testament"). In the MQTT protocol, an MQTT client can configure a will message to be broadcast from the MQTT message broker (MQTT server) whenever the server disconnects the MQTT client outside of a specific MQTT client disconnect request. Upon disconnect, the MQTT server will publish the will message for a given connection to the specified will topic name, with the specified Will QoS (Quality of Service). The will retain flag indicates whether the MQTT server saves the will message (and the corresponding will message parameters) across MQTT disconnection.

28.3.2 Syntax

| Type | Syntax | Response | Example |
|------|---|--|--|
| Set | AT+UMQTTWTOPIC=<Will_QoS>, <Will_Retain>,<Will_Topic> | [+UMQTTWTOPIC: <result>] OK | AT+UMQTTWTOPIC=0,0,"sensor/heat/SD/bldg5/DelMarConfRm/status" +UMQTTWTOPIC: 1 OK |
| Read | AT+UMQTTWTOPIC? | +UMQTTWTOPIC: <Will_QoS>, <Will_Retain>,<WT_length>,<Will_Topic> OK | +UMQTTWTOPIC: 2,1,22,"This is the will topic" OK |
| Test | AT+UMQTTWTOPIC=? | +UMQTTWTOPIC: (list of supported <Will_QoS>),(list of supported <Will_Retain>) OK | +UMQTTWTOPIC: (0-2),(0-1) OK |
| URC | | +UUMQTTWTOPIC: <Will_QoS>, <Will_Retain>,<Will_Topic> | +UUMQTTWTOPIC: 0,0,"user/u-blox" |

28.3.3 Defined values

| Parameter | Type | Description |
|---------------|--------|--|
| <Will_QoS> | Number | MQTT will Quality of Service: <ul style="list-style-type: none"> 0 (default value): at most once delivery 1: at least once delivery 2: exactly once delivery |
| <Will_Retain> | Number | Whether or not the will message will be retained across disconnects: <ul style="list-style-type: none"> 0 (default value): the will message will not be retained by the MQTT broker |

| Parameter | Type | Description |
|--------------|--------|---|
| | | <ul style="list-style-type: none"> 1: the will message will be retained by the MQTT broker |
| <Will_Topic> | String | Last will topic name. The maximum length is 256 characters. |
| <result> | Number | Operation result: <ul style="list-style-type: none"> 0: failure 1: success |
| <WT_length> | Number | Last will topic length. |

28.3.4 Notes

- If a connection is attempted when the will message is not valid (i.e., either the empty string or the default value), then the <Will_QoS> and <Will_Retain> parameters revert to default values.

SARA-R410M-63B / SARA-R410M-73B / SARA-R410M-83B

- The +UUMQTTWTOPIC URC is not supported.

SARA-R410M-02B / SARA-R410M-52B / SARA-R412M / SARA-N4

- The read command does not provide the information text response: only the final result code is issued.

28.4 MQTT will message configuration +UMQTTWMSG

| +UMQTTWMSG | | | | | | |
|-------------------|---|---------------------|-----------------------|-----------------------|----------------------|------------------------|
| Modules | SARA-R410M-02B SARA-R410M-52B SARA-R410M-63B SARA-R410M-73B SARA-R410M-83B SARA-R412M SARA-N4 | | | | | |
| Attributes | Syntax | PIN required | Settings saved | Can be aborted | Response time | Error reference |
| | partial | No | No | No | - | +CME Error |

28.4.1 Description

Configures the will message associated with the other MQTT profile parameters for an MQTT client's connection. In the MQTT protocol, an MQTT client can configure a will message to be broadcast from the MQTT message broker (MQTT server) whenever it disconnects the MQTT client outside of a specific MQTT client disconnect request.

28.4.2 Syntax

| Type | Syntax | Response | Example |
|------|--|--|--|
| Set | AT+UMQTTWMSG=<will_message>[,<hex_mode>] | [+UMQTTWMSG: <result>] OK | AT+UMQTTWMSG="Unrequested Disconnect. Please check network connectivity or battery life." +UMQTTWMSG: 1 OK |
| Read | AT+UMQTTWMSG? | +UMQTTWMSG: <wm_length>,<will_message> OK | +UMQTTWMSG: 74,"Unrequested Disconnect. Please check network connectivity or battery life." OK |
| Test | AT+UMQTTWMSG=? | OK | |
| URC | | +UUMQTTWMSG: <will_message> | +UUMQTTWMSG: "Unrequested Disconnect. Please check network connectivity or battery life." |

28.4.3 Defined values

| Parameter | Type | Description |
|----------------|--------|--|
| <will_message> | String | Last will message. ASCII or hexadecimal data. The maximum length is 256 characters. In case of hexadecimal data the parameter length must be even. The default value is an empty string. |
| <hex_mode> | Number | Allowed values: <ul style="list-style-type: none"> 0 (default value): ASCII input for <will_message> 1: hexadecimal input for <will_message> |

| Parameter | Type | Description |
|-------------|--------|--|
| <wm_length> | Number | Number of octets in <will_message>. |
| <result> | Number | Operation result: <ul style="list-style-type: none"> 0: failure 1: success |

28.4.4 Notes

SARA-R410M-02B / SARA-R410M-52B / SARA-R412M / SARA-N4

- The read command does not provide the information text response.
- The <hex_mode> and <wm_length> parameters are not supported.

SARA-R410M-63B / SARA-R410M-73B / SARA-R410M-83B

- The +UUMQTTWMSG URC is not supported.

28.5 Save/Restore MQTT profile from NVM +UMQTTNV

| +UMQTTNV | | | | | | |
|-------------------|---|---------------------|-----------------------|-----------------------|----------------------|------------------------|
| Modules | SARA-R410M-02B SARA-R410M-52B SARA-R410M-63B SARA-R410M-73B SARA-R410M-83B SARA-R412M SARA-R422M8S SARA-R422S SARA-N4 | | | | | |
| Attributes | Syntax | PIN required | Settings saved | Can be aborted | Response time | Error reference |
| | full | No | No | No | - | +CME Error |

28.5.1 Description

Either saves all of the MQTT client profile parameters to NVM (non-volatile memory) or sets all of the MQTT client profile parameters to either factory-programmed or non-volatile stored values.

For the complete list of parameters that can be stored in the NVM, see the [+UMQTT](#) AT command.



SARA-R422M8S / SARA-R422S

The set command does not provide the information text response: only the final result code is issued.

28.5.2 Syntax

| Type | Syntax | Response | Example |
|------|-----------------------|---|-------------------------------------|
| Set | AT+UMQTTNV=<NVM_mode> | [+UMQTTNV: <NVM_mode>, <result>] OK | AT+UMQTTNV=2 +UMQTTNV: 2,1 OK |
| Test | AT+UMQTTNV=? | +UMQTTNV: (list of <NVM_mode>s) OK | +UMQTTNV: (0-2) OK |

28.5.3 Defined values

| Parameter | Type | Description |
|------------|--------|---|
| <NVM_mode> | Number | Operation to set or save the MQTT client profile parameters as follows: <ul style="list-style-type: none"> 0: restore MQTT client profile parameters to the factory-programmed setting 1: set MQTT client profile parameters to values previously stored in the NVM 2: store current MQTT client profile parameters to the NVM |
| <result> | Number | Operation result: <ul style="list-style-type: none"> 0: failure 1: success |





28.6 MQTT command +UMQTTC

| +UMQTTC | | | | | | |
|-------------------|---|---------------------|-----------------------|-----------------------|----------------------|------------------------|
| Modules | SARA-R410M-02B SARA-R410M-52B SARA-R410M-63B SARA-R410M-73B SARA-R410M-83B SARA-R412M SARA-R422M8S SARA-R422S SARA-N4 | | | | | |
| Attributes | Syntax | PIN required | Settings saved | Can be aborted | Response time | Error reference |
| | partial | Yes | No | No | < 120 s | +CME Error |

28.6.1 Description

Triggers the MQTT actions corresponding to the <op_code> parameter. The final result code indicates if sending the command request to the MQTT process was successful or not.

The +UUMQTTC URC provides the result of the requested action from the MQTT broker. In addition, the +UUMQTTC URC also provides notification that unread messages are available from the MQTT server. The +UUMQTTC URC is by default enabled.

-  SARA-R410M-63B / SARA-R410M-73B / SARA-R410M-83B / SARA-R422M8S / SARA-R422S
An MQTT command can be considered completed only after receiving the related +UUMQTTC URC. The "+CME ERROR: operation not allowed" error result code is returned if an MQTT command is entered before the previous one is completed.
-  SARA-R410M-63B / SARA-R410M-73B / SARA-R410M-83B / SARA-R422M8S / SARA-R422S
The +UUMQTTC: 0,100 URC is notified when the MQTT broker releases the connection after a period of inactivity (timeout).
The +UUMQTTC: 0,101 URC is notified when the network connection is lost.
-  SARA-R422M8S / SARA-R422S
The +UUMQTTC: 0,102 URC is notified when the MT releases the connection because there is a protocol violation in receiving an MQTT message.
-  SARA-R410M-02B / SARA-R410M-52B / SARA-R412M / SARA-N4
The +UUMQTTC URC provides the result only for login and subscribe.
The +UUMQTTCM URC provides the contents of the received message when after having issued the AT +UMQTTC=6 command. The +UUMQTTCM URC is enabled by default.

28.6.2 SARA-R410M-02B / SARA-R410M-52B / SARA-R412M / SARA-N4 syntax

| Type | Syntax | Response | Example |
|--------------------------------|---|--|--|
| Generic syntax | | | |
| Set | AT+UMQTTC=<op_code>[,<param1>[,<param2>],<param3>],<param4>[,<param5>]] | +UMQTTC: <op_code>,<MQTT_result> OK | AT+UMQTTC=0 +UMQTTC: 0,1 OK |
| MQTT logout | | | |
| Set | AT+UMQTTC=0 | +UMQTTC: 0,<MQTT_result> OK | AT+UMQTTC=0 +UMQTTC: 0,1 OK |
| MQTT login | | | |
| Set | AT+UMQTTC=1 | +UMQTTC: 1,<MQTT_result> OK | AT+UMQTTC=1 +UMQTTC: 1,1 OK |
| URC | | +UUMQTTC: 1,<login_result> | +UUMQTTC: 1,0 |
| MQTT publish to a topic | | | |
| Set | AT+UMQTTC=2,<QoS>,<retain>[,<hex_mode>],<topic_name>,<message> | +UMQTTC: 2,<MQTT_result> OK | AT+UMQTTC=2,0,0,"sensor/heat/SD/bldg5/DelMarConfRm","23 degrees Celsius" +UMQTTC: 2,1 OK |

| Type | Syntax | Response | Example |
|---|--|--|--|
| | | | AT+UMQTTC=2,0,0,1,"sensor/ heat/SD/bldg5/DelMarConfRm", "3233206465677265657320 43656C73697573" +UMQTTC: 2,1 OK |
| MQTT publish a file to a topic | | | |
| Set | AT+UMQTTC=3,<QoS>,<retain>,<topic_name>,<filename> | +UMQTTC: 3,<MQTT_result> OK | AT+UMQTTC=3,0,0,"/home/u-blox", "/home/greetings/will.txt" +UMQTTC: 3,1 OK |
| MQTT subscribe to the specified topic filter | | | |
| Set | AT+UMQTTC=4,<max_QoS>,<topic_filter> | +UMQTTC: 4,<MQTT_result> OK | AT+UMQTTC=4,0,"sensor/heat/SD/ #" |
| URC | | +UUMQTTC: 4,<reason>,<QoS>,<topic_name> | +UUMQTTC: 4,0,2,"sensor/heat/SD/ #" |
| MQTT unsubscribe from the specified topic filter | | | |
| Set | AT+UMQTTC=5,<topic_filter> | +UMQTTC: 5,<MQTT_result> OK | AT+UMQTTC=5,"sensor/heat/SD/#" +UMQTTC: 5,1 OK |
| MQTT read message | | | |
| Set | AT+UMQTTC=6 | +UMQTTC: 6,<MQTT_result> OK | AT+UMQTTC=6 +UMQTTC: 6,1 OK |
| URC | | +UUMQTTC: 6,<num_unread_msgs> | +UUMQTTC: 6,3 |
| MQTT verbose/terse Reception format | | | |
| Set | AT+UMQTTC=7,<format> | +UMQTTC: 7,<MQTT_result> OK | AT+UMQTTC=7,1 +UMQTTC: 7,1 OK |
| Ping MQTT server | | | |
| Set | AT+UMQTTC=8,<mqtt_server> | +UMQTTC: 8,<MQTT_result> OK | AT+UMQTTC=8,"192.168.1.0" +UMQTTC: 8,1 OK |
| Test | AT+UMQTTC=? | +UMQTT: (list of supported <op_codes>s) OK | +UMQTTC: (0-8) OK |
| Generic syntax | | | |
| URC | | +UUMQTTC: <op_code>,<param1>[,<param2>,<param3> | +UUMQTTC: 4,0,2,"sensor/heat/SD/ #" |
| MQTT message | | | |
| URC | | +UUMQTTCM: <op_code>,<num_unread_msgs> [Topic: <topic_name>] [Len: <msg_length> QoS: <QoS>] Message: <message> | +UUMQTTCM: 6,1 Topic: sensor/ heat/SD/bldg5/DelMarConfRm Len: 16 QoS: 0 Message: 16 bytes of data |

28.6.3 SARA-R410M-63B / SARA-R410M-73B / SARA-R410M-83B / SARA-R422M8S / SARA-R422S syntax

| Type | Syntax | Response | Example |
|-----------------------|--------|----------|---------|
| Generic syntax | | | |

| Type | Syntax | Response | Example |
|---|--|---|---|
| Set | AT+UMQTTTC=<op_code>[,<param1>[,<param2>][, <param3>][, <param4>][, <param5>]] | OK | AT+UMQTTTC=1 OK |
| URC | | +UUMQTTTC: <op_code>,<param1>[, <param2>,<param3>] | +UUMQTTTC: 4,0,2,"sensor/heat/##" |
| MQTT logout | | | |
| Set | AT+UMQTTTC=0 | OK | AT+UMQTTTC=0 OK |
| URC | | +UUMQTTTC: 0,<logout_result> | +UUMQTTTC: 0,1 |
| MQTT login | | | |
| Set | AT+UMQTTTC=1 | OK | AT+UMQTTTC=1 OK |
| URC | | +UUMQTTTC: 1,<MQTT_result> | +UUMQTTTC: 1,1 |
| MQTT publish to a topic | | | |
| Set | AT+UMQTTTC=2,<QoS>,<retain>,[<hex_mode>],<topic_name>,<pub_msg> | OK | AT+UMQTTTC=2,0,0,0,"sensor/heat/SD/bldg5/DelMarConfRm","23 degrees Celsius" OK |
| | | | AT+UMQTTTC=2,0,0,1,"sensor/heat/SD/bldg5/DelMarConfRm","323320646567726565732043656C73697573" OK |
| URC | | +UUMQTTTC: 2,<MQTT_result> | +UUMQTTTC: 2,1 |
| MQTT publish a file to a topic | | | |
| Set | AT+UMQTTTC=3,<QoS>,<retain>,<topic_name>,<filename> | OK | AT+UMQTTTC=3,0,0,"home/u-blox","msg.txt" OK |
| URC | | +UUMQTTTC: 3,<MQTT_result> | +UUMQTTTC: 3,1 |
| MQTT subscribe to the specified topic filter | | | |
| Set | AT+UMQTTTC=4,<max_QoS>,<topic_filter> | OK | AT+UMQTTTC=4,0,"sensor/heat/##" OK |
| URC | | In case of success +UUMQTTTC: 4,1,<QoS>,<topic_name> In case of failure +UUMQTTTC: 4,0 | +UUMQTTTC: 4,1,0,"sensor/heat/##" |
| MQTT unsubscribe from the specified topic filter | | | |
| Set | AT+UMQTTTC=5,<topic_filter> | OK | AT+UMQTTTC=5,"sensor/heat/##" OK |
| URC | | +UUMQTTTC: 5,<MQTT_result> | +UUMQTTTC: 5,1 |
| MQTT read message | | | |
| Set | AT+UMQTTTC=6[,<one_message>] | +UMQTTTC: 6,<QoS>,<topic_msg_length>,<topic_length>,<topic_name>,<read_msg_length>,<read_msg> OK | AT+UMQTTTC=6,1 +UMQTTTC: 6,0,31,13,"sensor/heat/##",18,"23 degrees Celsius" OK |
| URC | | +UUMQTTTC: 6,<num_unread_msgs>,<memory_full> If an error occurs while receiving a publish message +UUMQTTTC: 6,0 | +UUMQTTTC: 6,3,0 |
| Ping MQTT broker | | | |
| Set | AT+UMQTTTC=8,<ping_ON_OFF> | OK | AT+UMQTTTC=8,1 OK |
| Publish a binary message to a topic | | | |

| Type | Syntax | Response | Example |
|------|--|---|---|
| Set | AT+UMQTTTC=9,<QoS>,<retain>,<topic_name>,<pub_msg_length> After the ">" prompt <pub_msg_length> bytes of data are entered | ><pub_bin_message> OK | AT+UMQTTTC=9,1,0,"u-blox/test",33 >AABB--> execute this \nand "this" OK |
| URC | | +UUMQTTTC: 9,<MQTT_result> | +UUMQTTTC: 9,1 |
| Test | AT+UMQTTTC=? | +UMQTT: (list of supported <op_codes>s) OK | +UMQTTTC: (0-9) OK |

28.6.4 Defined values

| Parameter | Type | Description |
|-----------------|--------|---|
| <op_code> | Number | MQTT command request. <ul style="list-style-type: none"> 0: logs out/disconnects from MQTT server. The will message will not be sent 1: logs in/connects to MQTT server 2: publish a message to a specific topic to the MQTT message broker 3: publish a message from a file to a specific topic to the MQTT message broker 4: subscribe to a topic from the MQTT message broker 5: unsubscribe to a topic from the MQTT message broker. This should exactly match the Topic Filter used during the Subscribe 6: read all unread messages received from MQTT message broker, at the terse/verbose mode set at the time of message reception 7: sets the terse/verbose format for received messages (i.e. the amount of information and headers with each received MQTT message) 8: ping the MQTT message broker 9: publish a message in binary mode. It is used for publishing any binary data Allowed values: <ul style="list-style-type: none"> SARA-R422M8S / SARA-R422S - 0, 1, 2, 3, 4, 5, 6, 8, 9 SARA-R410M-63B / SARA-R410M-73B / SARA-R410M-83B - 0, 1, 2, 3, 4, 5, 6, 8 SARA-R410M-02B / SARA-R410M-52B / SARA-R412M / SARA-N4 - 0, 1, 2, 3, 4, 5, 6, 7, 8 |
| <MQTT_result> | Number | Result of an MQTT command request: <ul style="list-style-type: none"> 0: fail; for more details, see the +UMQTTTER AT command 1: success |
| <login_result> | Number | Result of an MQTT login request. Allowed values: <ul style="list-style-type: none"> 0: connection accepted 1: the server does not support the level of the MQTT protocol requested by the client 2: the client identifier is correct UTF-8 but not allowed by the server 3: the network connection has been made but the MQTT service is unavailable 4: the data in the user name or password is malformed 5: the client is not authorized to connect 6-255: reserved for future use |
| <logout_result> | Number | Result of an MQTT command request: <ul style="list-style-type: none"> 0: fail; for more details, see the +UMQTTTER AT command 1: success Result of an unsolicited notification for an MQTT session interruption caused by: <ul style="list-style-type: none"> 100: timeout, the MQTT broker released the connection. 101: lost network connection. 102: protocol violation in receiving an MQTT message. |
| <QoS> | Number | Quality of service: <ul style="list-style-type: none"> 0 (default value): at most once delivery 1: at least once delivery 2: exactly once delivery |
| <retain> | Number | Whether or not the message will be retained across disconnects. Allowed values: <ul style="list-style-type: none"> 0 (default value): the message will not be retained by the MQTT broker 1: the message will be retained by the MQTT broker |
| <hex_mode> | Number | Allowed values: <ul style="list-style-type: none"> 0 (default value): ASCII input for <pub_msg>/<message> |

| Parameter | Type | Description |
|--------------------|--------|---|
| | | <ul style="list-style-type: none"> 1: hexadecimal input for <pub_msg>/<message> |
| <pub_msg> | String | ASCII or hexadecimal data. <ul style="list-style-type: none"> SARA-R4 - The maximum parameter length is 1024 characters if <hex_mode>=0 or 512 octets if <hex_mode>=1. |
| <message> | String | ASCII or hexadecimal data. The maximum length is 256 characters. The starting quotation mark shall not be taken into account like data. At the end of the byte stream, another quotation mark is provided for user convenience and visualization purposes. |
| <filename> | String | Filename containing the message to be published. <ul style="list-style-type: none"> SARA-R422M8S / SARA-R422S - The maximum parameter length is 250 characters and the maximum file content depends on the filesystem, see File system limits. SARA-R410M / SARA-R412M / SARA-N4 - The maximum parameter length is 250 characters and the maximum file content is 1024 characters. |
| <max_QoS> | Number | Maximum QoS level at which the MQTT broker can send messages to the MT. For more details, see MQTT version 3.1.1 - OASIS standard [199]. <ul style="list-style-type: none"> 0: at most once delivery 1: at least once delivery 2: exactly once delivery |
| <topic_filter> | String | An expression to indicate an interest in one or more topics, wildcard characters are used to subscribe/unsubscribe to multiple topics at once. See MQTT introduction . <ul style="list-style-type: none"> SARA-R4 / SARA-N4 - The maximum length is 256 characters. |
| <topic_name> | String | Indicates the topic to which the given MQTT message was published. <ul style="list-style-type: none"> SARA-R4 / SARA-N4 - The maximum length is 256 characters. |
| <reason> | Number | Result of an MQTT subscribe request: <ul style="list-style-type: none"> 0-2: success 128: failure Allowed values: <ul style="list-style-type: none"> SARA-R422M8S / SARA-R422S - 0, 128 SARA-R410M-02B / SARA-R410M-52B / SARA-R410M-63B / SARA-R410M-73B / SARA-R410M-83B / SARA-R412M / SARA-N4 - 0, 1, 2, 128 |
| <num_unread_msgs> | Number | Indicates the number of unread received messages. |
| <format> | Number | Specifies the format of the messages when read using the <op_code>=6. Allowed values: <ul style="list-style-type: none"> 0: no formatting. All messages will be concatenated into a single line with no separation between messages 1 (default value): each messages will contain the <topic_name> and <message> 2: each messages will contain the <topic_name>, <msg_length>, <QoS> and <message> |
| <mqtt_server> | String | IP address or URL of MQTT server. <ul style="list-style-type: none"> SARA-R410M-02B / SARA-R410M-52B / SARA-R410M-63B / SARA-R410M-73B / SARA-R410M-83B / SARA-R412M / SARA-N4 - The maximum length is 512 characters. |
| <one_message> | Number | Allowed values: <ul style="list-style-type: none"> 0: read all received messages 1: read only one message |
| <topic_msg_length> | Number | Sum of topic and message length |
| <topic_length> | Number | Topic length |
| <msg_length> | Number | Specifies the number of octets in <message> for <op_code>=6 (MQTT read message) |
| <read_msg_length> | Number | Specifies the number of octets in <read_msg> |
| <read_msg> | String | Message received from MQTT server. <ul style="list-style-type: none"> SARA-R422M8S / SARA-R422S - The maximum length is 12288 octets. SARA-R410M / SARA-R412M - The maximum length is 1024 octets. |
| <ping_ON_OFF> | Number | Allowed values: <ul style="list-style-type: none"> 0 (default value): ping disabled 1: ping enabled the MT will ping the MQTT broker. The ping is issued when the MQTT inactivity timeout period expires. See AT+UMQTT=10,<timeout>. |

| Parameter | Type | Description |
|-------------------|--------|--|
| <memory_full> | Number | Indicates the message memory status. Allowed values: <ul style="list-style-type: none"> • 0: message memory is available • 1: message memory is full |
| <pub_msg_length> | Number | Specifies the number of octets in <pub_bin_message>, the maximum length is 1024 octets. |
| <pub_bin_message> | String | Data bytes to be published. <ul style="list-style-type: none"> • SARA-R422M8S / SARA-R422S - The maximum length is 1024 octets. |

28.6.5 Notes

- The topic name should not include any wildcards for the publish commands.
- The topic filter could include the '+' wildcard to substitute for a single topic folder or the '#' wildcard to substitute for any number of topic folders. The '#' wildcard must be the last character in a topic filter.

SARA-R422M8S / SARA-R422S

- The <memory_full> parameter is not supported.
- If <hex_mode>=1, the publishing message (<pub_msg> parameter) contains a string of hexadecimal nebbles that is transformed into a bytes sequence
- Publish a binary message to a topic:
 - o This feature can be successfully used when there is need to send characters like <CR>, <CTRL-Z>, quotation marks, etc. These characters have a specific meaning and they cannot be used like data in the command itself. For more details, see 3GPP TS 27.005 [69].
 - o After the command is sent, the user waits for the > prompt. When it appears the stream of bytes can be provided. After the specified amount of bytes has been sent, the system provides the final result code. The feed process cannot be interrupted i.e. the return in the command mode can be effective only when the number of bytes provided is the declared one.
 - o In binary mode the module does not display the echo of data bytes.
- The time to establish the secure session (when using +UMQTT: 11,1[,<USECMNG_profile>]) could require up to 150 s in one of these cases:
 - o RoT generated PSK (+USECPRF: <profile_id>,11)
 - o encrypted session resumption (+USECPRF: <profile_id>,13,2,10)
 This is due to "security heartbeat" message operation. For more details on when this scenario occurs, see the +USECCONN AT command.

SARA-R410M-63B / SARA-R410M-73B / SARA-R410M-83B

- The <memory_full> parameter is not supported.
- If the <hex_mode> parameter is omitted also the comma before must be omitted.
- The +UUMQTTC: 6,0 URC is not supported.

SARA-R410M-02B / SARA-R410M-52B / SARA-R412M / SARA-N4

- Login to the MQTT server will have two responses, an immediate "+UMQTTC: 1,1" response that indicates that the module has sent the MQTT login request to the MQTT server. The MQTT server's login response will happen asynchronously when the MQTT server has finished processing the MQTT login request and decided whether or not to accept it.
- Subscription to a given topic filter will have two responses, an immediate "+UMQTTC: 4,1" response that indicates that the module has sent the MQTT subscription request to the MQTT server. The MQTT server's subscription response will happen asynchronously when the MQTT server has finished processing the MQTT subscription request and decided whether or not to accept it.
- The +UUMQTTC: 6,0 URC is not supported.

28.7 MQTT error +UMQTTER

| +UMQTTER | | | | | | |
|-------------------|---|---------------------|-----------------------|-----------------------|----------------------|--|
| Modules | SARA-R410M-02B SARA-R410M-52B SARA-R410M-63B SARA-R410M-73B SARA-R410M-83B SARA-R412M SARA-R422M8S SARA-R422S SARA-N4 | | | | | |
| Attributes | Syntax | PIN required | Settings saved | Can be aborted | Response time | Error reference |
| | partial | No | No | No | - | +CME Error MQTT Error |

28.7.1 SARA-R410M-02B / SARA-R410M-52B / SARA-R412M / SARA-N4

Description

Retrieves the error code and module (plus possible supplemental information) of the last MQTT operation that resulted in an error response.

28.7.2 SARA-R410M-63B / SARA-R410M-73B / SARA-R410M-83B / SARA-R422M8S / SARA-R422S

Description

Retrieves the error class and code of the last MQTT operation that provided an error.

28.7.3 Syntax

| Type | Syntax | Response | Example |
|--------|------------|---|-----------------------------------|
| Action | AT+UMQTTER | +UMQTTER: <error_code1>,<error_code2> OK | AT+UMQTTER +UMQTTER: 1,1 OK |

28.7.4 Defined values

| Parameter | Type | Description |
|---------------|--------|---|
| <error_code1> | Number | <ul style="list-style-type: none"> SARA-R410M-02B / SARA-R410M-52B / SARA-R412M / SARA-N4 - Value of error code. Values are listed in MQTT error codes. SARA-R410M-63B / SARA-R410M-73B / SARA-R410M-83B / SARA-R422M8S / SARA-R422S - Value of error class. Values are listed in Internet suite error classes. |
| <error_code2> | Number | <ul style="list-style-type: none"> SARA-R410M-02B / SARA-R410M-52B / SARA-R412M / SARA-N4 - Value of supplemental error code. The values are listed in MQTT supplemental error codes. SARA-R410M-63B / SARA-R410M-73B / SARA-R410M-83B / SARA-R422M8S / SARA-R422S - Value of class-specific error code. The values are listed in MQTT class error codes. |

29 MQTT-SN

29.1 Introduction

MQTT-SN AT commands are implemented according with MQTT-SN protocol specification version 1.2. For a more detailed overview on the MQTT-SN protocol, see MQTT-SN version 1.2 - standard [200].

The Message Queuing Telemetry Transport for Sensor Network (MQTT-SN) is a lightweight messaging protocol which is designed as close as MQTT. MQTT-SN is optimized for low bandwidth, high link failures and low cost. Specifically designed for low overhead, mobile devices with constrained resources of storage and management. The u-blox cellular modules can be configured to operate as an MQTT-SN client.

To publish or subscribe, the MQTT-SN client must first establish a UDP connection to a MQTT-SN gateway and register itself.

The MQTT-SN protocol specifies case-sensitive topics, with topic names containing topic level separators "/" to which messages will be published. For example, a message of "78 Fahrenheit or 25 Celsius" could be published to the topic name of "/heat/sensor/SD/bldg5/DelMarConfRm". MQTT-SN clients subscribe to topic filters to determine if the client receives messages published to a given topic name.

The topic filters may exactly specify a topic name or may contain either of the following wildcards:

- '+' - (single level wildcard) applies to a single topic level
- '#' - (multi-level wildcard) applies to potentially many topic levels (and must be the last character specified in a topic filter);

'#' can be specified on its own or following a topic level separator ('/'). For example, the topic filter, "/heat/sensor/SD/#", would receive any messages published to the "/heat/sensor/SD/bldg5/DelMarConfRm" topic name.

MQTT-SN specification states that topic filters starting with either wildcard will not match any topic name that starts with "\$".

The MQTT-SN protocol also specifies a Quality of Service (QoS) level to be applied to message transactions:

- -1: send and forget (value valid only for publish messages)
- 0 (default setting): at most once delivery
- 1: at least once delivery
- 2: exactly once delivery

The MQTT-SN protocol also allows an MQTT-SN client to create a will message, which the MQTT-SN remote server will store and only publish (to the topic name specified as the will topic name) when the MQTT-SN client gets disconnected from the MQTT-SN server, but not if the MQTT-SN client explicitly sends a disconnect command.

SARA-R422M8S / SARA-R422S
Broadcast messages are not supported so it is not possible to send a search gateway message or receive an advertisement from the gateway.

A PSD connection must be activated before using MQTT-SN AT commands.

SARA-R422M8S / SARA-R422S
See +UPSD for CID mapping and +CGACT for activating a PDP context.

29.2 MQTT-SN profile configuration +UMQTTSN

| +UMQTTSN | | | | | | |
|-------------------|-------------------------|---------------------|-----------------------|-----------------------|----------------------|------------------------|
| Modules | SARA-R422M8S SARA-R422S | | | | | |
| Attributes | Syntax | PIN required | Settings saved | Can be aborted | Response time | Error reference |
| | partial | No | +UMQTTSNNV | No | - | +CME Error |

29.2.1 Description

Configures or reads the parameter value of an MQTT-SN client profile. Issue a set command for each <op_code> parameter to set all of the parameters in an MQTT-SN client profile.

29.2.2 Syntax

| Type | Syntax | Response | Example |
|------------------------------------|--|---|---|
| Generic syntax | | | |
| Set | AT+UMQTTSN=<op_code>,<param1>[,<param2>] | OK | AT+UMQTTSN=12,1 OK |
| MQTT-SN unique client ID | | | |
| Set | AT+UMQTTSN=0,<client_id> | OK | AT+UMQTTSN=0,"352753090041680" OK |
| MQTT-SN server name | | | |
| Set | AT+UMQTTSN=1,<server_name>[,<server_port>] | OK | AT+UMQTTSN=1,"www.testMQTTSNbroker.com" OK |
| MQTT-SN server IP address | | | |
| Set | AT+UMQTTSN=2,<IP_address>[,<server_port>] | OK | AT+UMQTTSN=2,"192.168.1.0",1883 OK |
| MQTT-SN gateway radius | | | |
| Set | AT+UMQTTSN=3,<radius> | OK | AT+UMQTTSN=3,1 OK |
| Last will QoS | | | |
| Set | AT+UMQTTSN=4,<will_QoS> | OK | AT+UMQTTSN=4,1 OK |
| Last will retain | | | |
| Set | AT+UMQTTSN=5,<will_retain> | OK | AT+UMQTTSN=5,1 OK |
| Last will topic | | | |
| Set | AT+UMQTTSN=6,<will_topic> | OK | AT+UMQTTSN=6,"u-blox/publish" OK |
| Last will message | | | |
| Set | AT+UMQTTSN=7,<will_message> | OK | AT+UMQTTSN=7,"Unrequested disconnect." OK |
| MQTT-SN connection duration | | | |
| Set | AT+UMQTTSN=8,<duration> | OK | AT+UMQTTSN=8,20 OK |
| MQTT-SN secure option | | | |
| Set | AT+UMQTTSN=9,<secure>[,<USECMNG_profile>] | OK | AT+UMQTTSN=9,1 OK |
| MQTT-SN clean session | | | |
| Set | AT+UMQTTSN=10,<clean_session> | OK | AT+UMQTTSN=10,1 OK |
| Read | AT+UMQTTSN? | +UMQTTSN: 0,<client_id> +UMQTTSN: 1,<server_name>,<server_port> +UMQTTSN: 2,<IP_address>,<server_port> +UMQTTSN: 3,<radius> +UMQTTSN: 4,<will_QoS> +UMQTTSN: 5,<will_retain> +UMQTTSN: 6,<will_topic> +UMQTTSN: 7,<will_message> +UMQTTSN: 8,<duration> | +UMQTTSN: 0,"352753090041680" +UMQTTSN: 1,"www.commercialmqttbroker.com",1884 +UMQTTSN: 2,"192.168.1.0",1884 +UMQTTSN: 3,1 +UMQTTSN: 4,1 +UMQTTSN: 5,1 +UMQTTSN: 6,"u-blox/publish" +UMQTTSN: 7,"unrequested disconnect" +UMQTTSN: 8,<duration> |

| Type | Syntax | Response | Example |
|------|--------------|--|---|
| | | +UMQTTSN: 9,<secure>[, <USECMNG_profile>] +UMQTTSN: 10,<clean_session> OK | +UMQTTSN: 8,20 +UMQTTSN: 9,1,1 +UMQTTSN: 10,1 OK |
| Test | AT+UMQTTSN=? | +UMQTTSN: (list of supported <op_ code>s) OK | +UMQTTSN: (0-2,4-9) OK |

29.2.3 Defined values

| Parameter | Type | Description |
|-------------------|--------|---|
| <op_code> | Number | MQTT-SN parameter: <ul style="list-style-type: none"> 0: MQTT-SN unique client id 1: MQTT-SN server name 2: MQTT-SN IP address 3: MQTT-SN radius 4: MQTT-SN last will QoS 5: MQTT-SN last will retain 6: MQTT-SN last will topic 7: MQTT-SN last will message 8: MQTT-SN connection duration 9: MQTT-SN secure 10: MQTT-SN clean session |
| <client_id> | String | Client identifier for the MQTT-SN session. <ul style="list-style-type: none"> SARA-R422M8S / SARA-R422S - The maximum length is 256 characters. The default value is the IMEI of the MT. |
| <server_name> | String | Remote server name. The maximum length is 128 characters. The default value is an empty string. |
| <server_port> | Number | MQTT-SN server port. The range goes from 1 to 65535. The default value is 1884. |
| <IP_address> | String | Remote server IP address. The default value is an empty string. For IP address format reference, see the IP addressing . |
| <radius> | Number | The broadcast radius of this message. |
| <will_QoS> | Number | MQTT-SN last will quality of service: <ul style="list-style-type: none"> 0 (default value): at most once delivery 1: at least once delivery 2: exactly once delivery |
| <will_retain> | Number | Whether or not the last will message will be retained across disconnects: <ul style="list-style-type: none"> 0 (default value): the last will message will not be retained by the MQTT-SN gateway 1: the last will message will be retained by the MQTT-SN gateway |
| <will_topic> | String | Last will topic name. The maximum length is 256 characters. The default value is an empty string. |
| <will_message> | String | Last will message in ASCII format. The maximum length is 256 characters. The default value is an empty string. |
| <duration> | Number | Indicates the duration of the keep alive timer, expressed in seconds. According to the MQTT-SN version 1.2 - standard [200], an MQTT-SN server must disconnect a client if it receives nothing from the client within 1.5x the keep alive duration. The default value is 0, which indicates no timeout. The maximum value is 65535 (corresponding to 18 hours, 12 minutes and 15 seconds). |
| <clean_session> | Number | Clean session value. Allowed values: <ul style="list-style-type: none"> 0: indicates that the client subscription and delivered messages received by the client should be remembered across disconnections by both the MQTT-SN client and the MQTT-SN server 1 (default value): indicates that disconnections clean all session state information |
| <secure> | Number | Enables / disables the secure option of the MQTT-SN service: <ul style="list-style-type: none"> 0: (default value): no DTLS encryption 1: enable the MQTT-SN DTLS encryption |
| <USECMNG_profile> | Number | USECMNG profile. Defines the USECMNG profile which specifies the SSL/TLS/DTLS properties to be used for the SSL/TLS/DTLS connection. The range goes from 0 to 4. |

| Parameter | Type | Description |
|-----------|-----------------|--|
| | | If no profile is set a default USECMNG profile is used (see +USECMNG AT command description). The parameter is omitted in the information text response to the read command if <secure>=0. |
| <param1> | Number / String | Type and supported content depend on the related <op_code> parameter (details are given above). <param1> is compulsory parameter in set command. |
| <param2> | Number / String | Type and supported content depend on the related <op_code> parameter (details are given above). If <param2> is not specified the value of the corresponding parameter <op_code> is reset to the default value. |

29.2.4 Notes

- <op_code>=1 (server name) and <op_code>=2 (IP address) are equivalent, when the broker connection is established the server name is transformed into the IP address.

SARA-R422M8S / SARA-R422S

- <op_code>=3 (radius for broadcasting search gateway message) is not supported.
- <op_code>=10 (clean session) is supported only to maintain server-side persistence (subscription and will data persistency).

29.3 Save/Restore MQTT-SN profile from NVM +UMQTTSNV

| +UMQTTSNV | | | | | | |
|------------|-------------------------|--------------|----------------|----------------|---------------|----------------------------|
| Modules | SARA-R422M8S SARA-R422S | | | | | |
| Attributes | Syntax | PIN required | Settings saved | Can be aborted | Response time | Error reference |
| | full | No | No | No | - | +CME Error |

29.3.1 Description

Either saves all of the MQTT-SN client profile parameters to NVM (non-volatile memory) or sets all of the MQTT-SN client profile parameters to either factory-programmed or non-volatile stored values.

For the complete list of parameters that can be stored in the NVM, see the [+UMQTTSN](#) AT command.

29.3.2 Syntax

| Type | Syntax | Response | Example |
|------|------------------------|--|------------------------|
| Set | AT+UMQTTSNV=<NVM_mode> | OK | AT+UMQTTSNV=2 OK |
| Test | AT+UMQTTSNV=? | +UMQTTSNV: (list of <NVM_mode>s) OK | +UMQTTSNV: (0-2) OK |

29.3.3 Defined values

| Parameter | Type | Description |
|------------|--------|---|
| <NVM_mode> | Number | Operation to set or save the MQTT-SN client profile parameters as follows: <ul style="list-style-type: none"> • 0: restore MQTT-SN client profile parameters to the factory-programmed setting • 1: set MQTT-SN client profile parameters to values previously stored in the NVM • 2: store current MQTT-SN client profile parameters to the NVM |

29.4 MQTT-SN command +UMQTTSNC

| +UMQTTSNC | | | | | | |
|-------------------|-------------------------|---------------------|-----------------------|-----------------------|----------------------|------------------------|
| Modules | SARA-R422M8S SARA-R422S | | | | | |
| Attributes | Syntax | PIN required | Settings saved | Can be aborted | Response time | Error reference |
| | partial | No | No | No | - | +CME Error |

29.4.1 Description

Triggers the MQTT-SN actions corresponding to the <op_code> parameter. The final result code indicates if sending the command request to the MQTT-SN process was successful or not.

The +UUMQTTSNC URC provides the result of the requested action from the MQTT-SN gateway. In addition, the +UUMQTTSNC URC also provides the notification that unread messages are available from the MQTT-SN gateway. The +UUMQTTSNC URC is by default enabled.



SARA-R422M8S / SARA-R422S

The +UUMQTTSNC: 0,100 URC is notified when the MQTT-SN gateway releases the connection.

The +UUMQTTSNC: 0,101 URC is notified when the network connection is lost.

29.4.2 Syntax

| Type | Syntax | Response | Example |
|----------------------------|---|--|--|
| Generic syntax | | | |
| Set | AT+UMQTTSNC=<op_code>[,<param1>[,<param2>[,<param3>],<param4>[,<param5>,<param6>]]] | [+UMQTTSNC: <op_code>,<param1>[,<param2>,<param3>,<param4>,<param5>,<param6>]] | AT+UMQTTSNC=1 +UMQTTSNC: 1,1 OK |
| MQTT-SN disconnect | | | |
| Set | AT+UMQTTSNC=0[,<duration>] | OK | AT+UMQTTSNC=0 OK |
| URC | | +UUMQTTSNC: 0,<logout_result> | +UUMQTTSNC: 0,1 |
| MQTT-SN connect | | | |
| Set | AT+UMQTTSNC=1 | OK | AT+UMQTTSNC=1 OK |
| URC | | +UUMQTTSNC: 1,<MQTTSN_result> | +UUMQTTSNC: 1,1 |
| MQTT-SN register | | | |
| Set | AT+UMQTTSNC=2,<topic_name> | OK | AT+UMQTTSNC=2,"sensor/heat/SD" OK |
| URC | | +UUMQTTSNC: 2,<MQTTSN_result>,<topic_id> | +UUMQTTSNC: 2,1,1 |
| MQTT-SN publish | | | |
| Set | AT+UMQTTSNC=4,<QoS>,<retain>,<hex_mode>,<topic_type>,<topic>,<message> | OK | AT+UMQTTSNC=4,1,0,0,0,"1","23 degrees Celsius" OK |
| URC | | +UUMQTTSNC: 4,<MQTTSN_result> | +UUMQTTSNC: 4,1 |
| MQTT-SN subscribe | | | |
| Set | AT+UMQTTSNC=5,<max_QoS>,<topic_type>,<topic> | OK | AT+UMQTTSNC=5,1,0,"sensor/heat/SD" OK |
| URC | | +UUMQTTSNC: 5,<MQTTSN_result>,<g_QoS>,<topic_id_sub> | +UUMQTTSNC: 5,1,0,1 |
| MQTT-SN unsubscribe | | | |
| Set | AT+UMQTTSNC=6,<topic_type>,<topic> | OK | AT+UMQTTSNC=6,1,"1" OK |
| URC | | +UUMQTTSNC: 6,<MQTTSN_result> | +UUMQTTSNC: 6,1 |

| Type | Syntax | Response | Example |
|---|---|--|--|
| MQTT-SN will topic update | | | |
| Set | AT+UMQTTSNC=7,<will_QoS>,<will_retain>,<will_topic> | OK | AT+UMQTTSNC=7,1,0,"sensor/heat/SD/lastwill" OK |
| URC | | +UUMQTTSNC: 7,<MQTTSN_result> | +UUMQTTSNC: 7,1 |
| MQTT-SN will message update | | | |
| Set | AT+UMQTTSNC=8,<will_message> | OK | AT+UMQTTSNC=8,"Unrequested disconnect" OK |
| URC | | +UUMQTTSNC: 8,<MQTTSN_result> | +UUMQTTSNC: 8,1 |
| MQTT-SN read message | | | |
| Set | AT+UMQTTSNC=9[,<one_message>] | +UMQTTSNC: 9,<QoS>,<topic_type>,<topic_msg_length>,<topic_length>,<topic>,<msg_length>,<message> OK | AT+UMQTTSNC=9,1 +UMQTTSNC: 9,1,0,19,1,"1",18,"23 degrees Celsius" OK |
| URC | | +UUMQTTSNC: 9,<num_unread_msgs> | +UUMQTTSNC: 9,2 |
| MQTT-SN ping | | | |
| Set | AT+UMQTTSNC=10,<ping_ON_OFF> | OK | AT+UMQTTSNC=10,1 OK |
| URC (only in case of no ping response received) | | +UUMQTTSNC: 10,0 | +UUMQTTSNC: 10,0 |
| MQTT-SN publish a file to a topic | | | |
| Set | AT+UMQTTSNC=11,<QoS>,<retain>,<topic_type>,<topic>,<filename> | OK | AT+UMQTTSNC=11,1,0,0,"2","msg.txt" OK |
| URC | | +UUMQTTSNC: 11,<MQTTSN_result> | +UUMQTTSNC: 11,1 |
| Test | AT+UMQTTSNC=? | +UMQTTSN: (list of supported <op_codes>s) OK | +UMQTTSNC: (0-2,4-11) OK |
| URC | | +UUMQTTSNC: <op_code>,<param1>[,<param2>],...,<paramN>] | +UUMQTTSNC: 5,1,0,1 |

29.4.3 Defined values

| Parameter | Type | Description |
|-----------------|--------|--|
| <op_code> | Number | MQTT-SN command request. Allowed values: <ul style="list-style-type: none"> 0: logs out/disconnects from the MQTT-SN server. The will message will not be sent 1: logs in/connects to the MQTT-SN server 2: register message to request a topic ID against a normal topic name from the gateway 3: search gateway message; broadcasted by a client when it searches for a gateway 4: publish a message to a specific topic to the gateway 5: subscribe to a topic 6: unsubscribe to a topic. This should exactly match the topic filter used during the Subscribe 7: update the will topic name stored in the gateway/server 8: update the will message stored in the gateway/server 9: read all unread messages received from the gateway 10: ping the MQTT-SN gateway 11: publish a message from a file to a specific topic to the gateway |
| <duration> | Number | Indicates the value of the sleep timer in seconds; the default value is 0. |
| <MQTTSN_result> | Number | Result of a MQTT-SN command request: <ul style="list-style-type: none"> 0: fail; for more details, see the +UMQTTSNER AT command |

| Parameter | Type | Description |
|------------------|--------|---|
| | | <ul style="list-style-type: none"> 1: success |
| <login_result> | Number | Result of a MQTT-SN login request. Allowed values: <ul style="list-style-type: none"> 0: connection accepted 1: rejected due to a congestion 2: rejected due to an invalid topic ID 3: rejected because not supported 4-255: reserved for future use |
| <logout_result> | Number | Result of an MQTT-SN command request: <ul style="list-style-type: none"> 0: fail; for more details, see the +UMQTTSNER AT command 1: success Result of an unsolicited notification for an MQTT-SN session interruption caused by: <ul style="list-style-type: none"> 100: timeout, the MQTT-SN gateway released the connection. 101: lost network connection. |
| <topic_name> | String | Indicates the topic name to request a topic ID value from the gateway. |
| <topic_id> | Number | Indicates the topic ID value to be used in the publish messages. |
| <gateway_id> | Number | Indicates the gateway ID. |
| <QoS> | Number | Quality of service: <ul style="list-style-type: none"> 0: at most once delivery 1: at least once delivery 2: exactly once delivery 3: special publish QoS of 3. It is also known as QoS-1 (see MQTT-SN introduction) |
| <retain> | Number | Whether or not the message will be retained across disconnections. Allowed values: <ul style="list-style-type: none"> 0: the message will not be retained by the MQTT broker 1: the message will be retained by the MQTT broker |
| <hex_mode> | Number | Allowed values: <ul style="list-style-type: none"> 0 (default value): ASCII input for <message> 1: hexadecimal input for <message> |
| <topic_type> | Number | Indicates the type of the topic contained in the topic field: <ul style="list-style-type: none"> 0: normal 1: predefined 2: short |
| <topic> | String | Contains the topic ID value or the short/normal topic name for which the data is published. |
| <message> | String | ASCII or hexadecimal data. The starting quotation mark shall not be taken into account like data. At the end of the byte stream, another quotation mark is provided for user convenience and visualization purposes. |
| <publish_result> | Number | Result of a MQTT-SN publish request. Allowed values: <ul style="list-style-type: none"> 0: accepted 1: rejected due to an invalid topic ID 2: rejected due to congestion |
| <max_QoS> | Number | Maximum requested QoS level for this topic: <ul style="list-style-type: none"> 0: at most once delivery 1: at least once delivery 2: exactly once delivery |
| <sub_result> | Number | Result of a MQTT-SN subscription request. Allowed values: <ul style="list-style-type: none"> 0: accepted 1: rejected due to an invalid topic ID 2: rejected due to congestion |
| <g_QoS> | Number | Indicates the granted QoS level. |
| <topic_id_sub> | Number | Indicates the topic ID when sending publish messages from the gateway to the client. Not relevant in case of subscriptions to a short topic name or a topic name which contains wildcard characters. |
| <will_QoS> | Number | Indicates the last will QoS level. Allowed values: <ul style="list-style-type: none"> 0: at most once delivery 1: at least once delivery 2: exactly once delivery |

| Parameter | Type | Description |
|--------------------|-----------------|---|
| <will_retain> | Number | Whether or not the last will message will be retained across disconnections: <ul style="list-style-type: none"> • 0: the last will message will not be retained by the MQTT-SN gateway • 1: the last will message will be retained by the MQTT-SN gateway |
| <will_topic> | String | Indicates the will topic name. Setting it as an empty string will delete <will_topic> and <will_message> stored in the gateway/server. |
| <will_message> | String | Will message. |
| <num_unread_msgs> | Number | Indicates the number of unread received messages. |
| <msg_length> | Number | Specifies the number of octets in <message>. |
| <rcv_message> | String | ASCII data. The starting quotation mark shall not be taken into account like data. At the end of the byte stream, another quotation mark is provided for user convenience and visualization purposes. |
| <topic_length> | Number | Topic length |
| <topic_msg_length> | Number | Sum of topic and message length |
| <one_message> | Number | Allowed values: <ul style="list-style-type: none"> • 0: read all received messages • 1: read only one message |
| <ping_ON_OFF> | Number | Allowed values: <ul style="list-style-type: none"> • 0 (default value): ping disabled • 1: ping enabled; the MT will ping the MQTT-SN gateway. The ping is issued when the MQTT-SN keep alive period expires. See AT+UMQTT=8,<duration> |
| <paramx> | Number / String | Type and supported content depend on the related <op_code> parameter (details are given above). |
| <filename> | String | File name containing the payload of the message to be published. The maximum parameter length is 250 characters and the maximum file content is 1017 characters. |

29.4.4 Notes

SARA-R422M8S / SARA-R422S

- The time to establish the secure session (when using [+UMQTTSN: 11,1,<USECMNG_profile>](#)) could require up to 150 s in one of these cases:
 - RoT generated PSK ([+USECPRF: <profile_id>,11](#))
 - encrypted session resumption ([+USECPRF: <profile_id>,13,2,10](#))
 This is due to "security heartbeat" message operation. For more details on when this scenario occurs, see the [+USECCONN](#) AT command.
- When the module exits from the sleeping mode (with the [AT+UMQTTSN=1](#) connect command) the received and not read publish messages are deleted.
- Only predefined topic id or short topic name are allowed in case of publishing a message with QoS level -1.

29.5 MQTT-SN error +UMQTTSNER

| +UMQTTSNER | | | | | | |
|------------|-------------------------|--------------|----------------|----------------|---------------|--|
| Modules | SARA-R422M8S SARA-R422S | | | | | |
| Attributes | Syntax | PIN required | Settings saved | Can be aborted | Response time | Error reference |
| | full | No | No | No | - | +CME Error MQTT-SN error |

29.5.1 Description

Retrieves the error class and code of the last MQTT-SN operation that provided an error.

29.5.2 Syntax

| Type | Syntax | Response | Example |
|------|--------------|--|--|
| Set | AT+UMQTTSNER | +UMQTTSNER: <error_class>, <error_code> OK | AT+UMQTTSNER +UMQTTSNER: 14,1 OK |

29.5.3 Defined values

| Parameter | Type | Description |
|---------------|--------|--|
| <error_class> | Number | Value of error class. Values are listed in Internet suite error classes . |
| <error_code> | Number | Value of class-specific error code. The values are listed in MQTT-SN class error codes . |

30 Lightweight M2M

30.1 LwM2M Objects management

30.1.1 Introduction

30.1.1.1 SARA-R4 object management

Lightweight M2M is a protocol from the Open Mobile Alliance (OMA) that defines the application layer communication between a LwM2M server and a LwM2M client. LwM2M includes device management and service enablement for LwM2M devices. For more details on LwM2M protocol, see Lightweight Machine to Machine Technical Specification [198].

LwM2M objects implemented as Lua scripts act as the container for the objects, object instances, and resources.

u-blox cellular modules allows adding, removing or querying an object from the LwM2M object table of available objects with these AT commands:

- **+ULWM2MADD** dynamically adds an object, that has been previously copied to the device file system, to the LwM2M object table. An object must be added to the LwM2M object table before create or delete operations can be performed. The LwM2M object shall be downloaded by means of file system AT commands with the "XLWM2M" tag, for more details see [File tags](#).
- **+ULWM2MREMOVE** dynamically removes an object from the LwM2M object table, along with any existing instances. The object file on the device file system is not removed. An object that has been removed from the LwM2M object table cannot have a create operation performed.
- **+ULWM2MLIST** lists the object ID and the object instances of a specific LwM2M object. The command allows also to list the object IDs of all objects and object instances in the LwM2M object table. An object that does not appear listed by **+ULWM2MLIST** must be added before create operations can be performed.



SARA-R4

All the LwM2M objects, that are stored in the MT as Lua scripts with the "XLWM2M" tag, are automatically added to the LwM2M object table during LwM2M client initialization at device power up.

The LwM2M object table is empty by factory-programmed setting.

Additional object files may be added by means of file system AT commands with the "XLWM2M" tag, for more details see [File tags](#).

It is possible to modify LwM2M objects that have already been added to the LwM2M object table, using the following AT commands:

- **+ULWM2MCREATE** creates an object instance associated with a given server ID. The object must already be added to the LwM2M object table (see **+ULWM2MADD** AT command).
- **+ULWM2MDELETE** deletes an object instance. The delete target must already exist and be listed by the **+ULWM2MLIST** AT command.
- **+ULWM2MWRITE** writes to an object instance or resource. The instance must already exist and be listed by the **+ULWM2MLIST** AT command. Otherwise, it must be added with **+ULWM2MLIST** before writing.
- **+ULWM2MREAD** reads an object, object instance, or resource. The read target must already exist and be listed by the **+ULWM2MLIST** AT command.



SARA-R4

For the **+ULWM2MADD**, **+ULWM2MREMOVE**, **+ULWM2MLIST**, **+ULWM2MCREATE**, **+ULWM2MWRITE**, **+ULWM2MREAD** AT commands the maximum length of the command line and the maximum length of the information text response is 1040 characters.

30.1.2 Load LwM2M object definition +ULWM2MADD

| +ULWM2MADD | | | | | | |
|-------------------|--|---------------------|-----------------------|-----------------------|----------------------|----------------------------|
| Modules | SARA-R410M-02B SARA-R410M-63B SARA-R410M-73B SARA-R410M-83B SARA-R412M SARA-R422 SARA-R422M8S SARA-R422S | | | | | |
| Attributes | Syntax | PIN required | Settings saved | Can be aborted | Response time | Error reference |
| | full | No | No | No | - | +CME Error |

30.1.2.1 Description

Loads a LwM2M object into LwM2M objects table from a Lua definition file. Additional Lua definition files can be stored into the file system by means of the [+UDWNFILE](#) AT command using "XLWM2M" tag (for more details, see [File tags](#)).

30.1.2.2 Syntax

| Type | Syntax | Response | Example |
|------|-------------------------|------------------------------|--|
| Set | AT+ULWM2MADD=<filename> | OK | AT+ULWM2MADD="object_location.lua" OK |
| Test | AT+ULWM2MADD=? | +ULWM2MADD: "filename" OK | +ULWM2MADD: "filename" OK |

30.1.2.3 Defined values

| Parameter | Type | Description |
|------------|--------|---|
| <filename> | String | Name of the Lua file defining an object to load. The directory is assumed to be /lua/ objects on alternate encrypted file system. |

30.1.2.4 Notes

SARA-R410M / SARA-R412M

- In case of error only the "ERROR" final result code is returned.

SARA-R410M-02B / SARA-R412M

- The command is not supported by SARA-R410M-02B-00, SARA-R410M-02B-01, SARA-R410M-02B-02, SARA-R412M-02B-00, SARA-R412M-02B-01, SARA-R412M-02B-02.

30.1.3 Remove LwM2M object definition +ULWM2MREMOVE

| +ULWM2MREMOVE | | | | | | |
|----------------------|--|---------------------|-----------------------|-----------------------|----------------------|----------------------------|
| Modules | SARA-R410M-02B SARA-R410M-63B SARA-R410M-73B SARA-R410M-83B SARA-R412M SARA-R422 SARA-R422M8S SARA-R422S | | | | | |
| Attributes | Syntax | PIN required | Settings saved | Can be aborted | Response time | Error reference |
| | full | No | No | No | - | +CME Error |

30.1.3.1 Description

Deletes all instances of an object and removes the object definition from LwM2M objects table. The Lua file is NOT deleted.

30.1.3.2 Syntax

| Type | Syntax | Response | Example |
|------|-----------------------------|----------------------------------|----------------------------------|
| Set | AT+ULWM2MREMOVE=<object_ID> | OK | AT+ULWM2MREMOVE="/3300" OK |
| Test | AT+ULWM2MREMOVE=? | +ULWM2MREMOVE: "Object Id" OK | +ULWM2MREMOVE: "Object Id" OK |

30.1.3.3 Defined values

| Parameter | Type | Description |
|-------------|--------|---|
| <object_id> | String | URI to an object ID for an object loaded into LwM2M objects table |

30.1.3.4 Notes

SARA-R410M / SARA-R412M

- In case of error only the "ERROR" final result code is returned.

SARA-R410M-02B / SARA-R412M

- The command is not supported by SARA-R410M-02B-00, SARA-R410M-02B-01, SARA-R410M-02B-02, SARA-R412M-02B-00, SARA-R412M-02B-01, SARA-R412M-02B-02.

30.1.4 List available LwM2M objects +ULWM2MLIST

| +ULWM2MLIST | | | | | | |
|-------------------|--|---------------------|-----------------------|-----------------------|----------------------|------------------------|
| Modules | SARA-R410M-02B SARA-R410M-63B SARA-R410M-73B SARA-R410M-83B SARA-R412M SARA-R422 SARA-R422M8S SARA-R422S | | | | | |
| Attributes | Syntax | PIN required | Settings saved | Can be aborted | Response time | Error reference |
| | full | No | No | No | - | +CME Error |

30.1.4.1 Description

Lists all the instances of a specific LwM2M object. In order to list all the existing LwM2M objects and instances in the LwM2M object table issue the AT+ULWM2MLIST="/" command. If an object has no current instances, only the object ID is listed.

30.1.4.2 Syntax

| Type | Syntax | Response | Example |
|------|----------------------------|--|--|
| Set | AT+ULWM2MLIST=<object_URI> | +ULWM2MLIST: [<1st_URI>[,<2nd_URI>[,...[,<nth_URI>]]]] OK | AT+ULWM2MLIST="/" +ULWM2MLIST: "/1/1","/1/2","/2/1", "/2/2","/2/3","/2/4","/2/5","/2/6","/2/7", "/2/8","/2/0","/3/0","/4/0","/3300" OK |
| Test | AT+ULWM2MLIST=? | OK | OK |

30.1.4.3 Defined values

| Parameter | Type | Description |
|-------------------------|--------|---|
| <object_URI> | String | Uniform Resource Identifier (URI) of the LwM2M object to query. The format is "/object_ID". By means of the special value "/" all the existing LwM2M objects and instances are returned. |
| <1st_URI>,...,<nth_URI> | String | Uniform Resource Identifier (URI) to existing object |

30.1.4.4 Notes

SARA-R410M / SARA-R412M

- In case of error only the "ERROR" final result code is returned.

SARA-R410M-02B / SARA-R412M

- The command is not supported by SARA-R410M-02B-00, SARA-R410M-02B-01, SARA-R410M-02B-02, SARA-R412M-02B-00, SARA-R412M-02B-01, SARA-R412M-02B-02.

30.1.5 Create new instance of LwM2M object +ULWM2MCREATE

| +ULWM2MCREATE | | | | | | |
|-------------------|--|---------------------|-----------------------|-----------------------|----------------------|------------------------|
| Modules | SARA-R410M-02B SARA-R410M-63B SARA-R410M-73B SARA-R410M-83B SARA-R412M SARA-R422 SARA-R422M8S SARA-R422S | | | | | |
| Attributes | Syntax | PIN required | Settings saved | Can be aborted | Response time | Error reference |
| | full | No | No | No | - | +CME Error |

30.1.5.1 Description

Creates a new instance of a LwM2M object.

30.1.5.2 Syntax

| Type | Syntax | Response | Example |
|------|------------------------------------|--|--|
| Set | AT+ULWM2MCREATE=<JSON>,<server_id> | OK | AT+ULWM2MCREATE="{\"bn\": \"16/0\", \"e\": [{\"n\": \"0/0\", \"sv\": \"HMANO\"}, {\"n\": \"0/1\", \"sv\": \"HMOD0\"}, {\"n\": \"0/2\", \"sv\": \"HSW0\"}, {\"n\": \"0/3\", \"sv\": \"HUID0\"}]}, 721 OK |
| Test | AT+ULWM2MCREATE=? | +ULWM2MCREATE: \"JSON\",(list of supported <server_id>s) OK | +ULWM2MCREATE: \"JSON\",(1-65534) OK |

30.1.5.3 Defined values

| Parameter | Type | Description |
|-------------|--------|---|
| <JSON> | String | JSON-formatted LwM2M resource or object instance; for more details, Lightweight Machine to Machine Technical Specification [198]. If the JSON data contains embedded double quotes, they must be properly escaped with a backslash character \. |
| <server_id> | Number | Short server ID of the LwM2M server owner of the associated object instance. The range goes from 1 to 65534. |

30.1.5.4 Notes

SARA-R410M / SARA-R412M

- In case of error only the "ERROR" final result code is returned.

SARA-R410M-02B / SARA-R412M

- The command is not supported by SARA-R410M-02B-00, SARA-R410M-02B-01, SARA-R410M-02B-02, SARA-R412M-02B-00, SARA-R412M-02B-01, SARA-R412M-02B-02.

30.1.6 Delete instance of LwM2M object +ULWM2MDELETE

| +ULWM2MDELETE | | | | | | |
|---------------|--|--------------|----------------|----------------|---------------|-----------------|
| Modules | SARA-R410M-02B SARA-R410M-63B SARA-R410M-73B SARA-R410M-83B SARA-R412M SARA-R422 SARA-R422M8S SARA-R422S | | | | | |
| Attributes | Syntax | PIN required | Settings saved | Can be aborted | Response time | Error reference |
| | full | No | No | No | - | +CME Error |

30.1.6.1 Description

Deletes an instance of a LwM2M object.

30.1.6.2 Syntax

| Type | Syntax | Response | Example |
|------|-----------------------|---|---|
| Set | AT+ULWM2MDELETE=<URI> | OK | AT+ULWM2MDELETE=\"/14/7\" OK |
| Test | AT+ULWM2MDELETE=? | +ULWM2MDELETE: \"Object Id/ Resource Id\" OK | +ULWM2MDELETE: \"Object Id/ Resource Id\" OK |

30.1.6.3 Defined values

| Parameter | Type | Description |
|-----------|--------|--|
| <URI> | String | Uniform Resource Identifier (URI) to existing object |

30.1.6.4 Notes

SARA-R410M / SARA-R412M

- In case of error only the "ERROR" final result code is returned.

SARA-R410M-02B / SARA-R412M

- The command is not supported by SARA-R410M-02B-00, SARA-R410M-02B-01, SARA-R410M-02B-02, SARA-R412M-02B-00, SARA-R412M-02B-01, SARA-R412M-02B-02.

30.1.7 Write to LwM2M object +ULWM2MWRITE

| +ULWM2MWRITE | | | | | | |
|-------------------|--|---------------------|-----------------------|-----------------------|----------------------|------------------------|
| Modules | SARA-R410M-02B SARA-R410M-63B SARA-R410M-73B SARA-R410M-83B SARA-R412M SARA-R422 SARA-R422M8S SARA-R422S | | | | | |
| Attributes | Syntax | PIN required | Settings saved | Can be aborted | Response time | Error reference |
| | full | No | No | No | - | +CME Error |

30.1.7.1 Description

Writes a LwM2M object, object instance, or resource.

30.1.7.2 Syntax

| Type | Syntax | Response | Example |
|------|---------------------------------|----------------------------|--|
| Set | AT+ULWM2MWRITE=<JSON>[, <mode>] | OK | AT+ULWM2MWRITE="{\"bn\":1/1/\\\", \"e\":[{\n\":1\\\", \"v\":1000}]}" OK |
| Test | AT+ULWM2MWRITE=? | +ULWM2MWRITE: "JSON" OK | +ULWM2MWRITE: "JSON" OK |

30.1.7.3 Defined values

| Parameter | Type | Description |
|-----------|--------|--|
| <JSON> | String | JSON-formatted LwM2M resource or object instance; for more details, Lightweight Machine to Machine Technical Specification [198]. If the JSON data contains embedded double quotes, they must be properly escaped with a backslash character \\. An empty string causes the LwM2M data to be immediately written into the file system. |
| <mode> | Number | Allowed values: <ul style="list-style-type: none"> 0 (default value): partial write that changes only resources given 1: replace write, overwriting multi-instance resources with the array passed in JSON |

30.1.7.4 Notes

SARA-R422 / SARA-R422M8S / SARA-R422S

- The <JSON> parameter does not support empty string.

SARA-R410M-63B / SARA-R410M-73B / SARA-R410M-83B

- The <JSON> parameter does not support empty string.
- In case of error only the "ERROR" final result code is returned.

SARA-R410M-02B / SARA-R412M

- The command is not supported by SARA-R410M-02B-00, SARA-R410M-02B-01, SARA-R410M-02B-02, SARA-R412M-02B-00, SARA-R412M-02B-01, SARA-R412M-02B-02.
- The <JSON> parameter does not support empty string.
- In case of error only the "ERROR" final result code is returned.

30.1.8 Read from LwM2M object +ULWM2MREAD

| +ULWM2MREAD | | | | | | |
|-------------------|--|---------------------|-----------------------|-----------------------|----------------------|------------------------|
| Modules | SARA-R410M-02B SARA-R410M-63B SARA-R410M-73B SARA-R410M-83B SARA-R412M SARA-R422 SARA-R422M8S SARA-R422S | | | | | |
| Attributes | Syntax | PIN required | Settings saved | Can be aborted | Response time | Error reference |
| | full | No | No | No | - | +CME Error |

30.1.8.1 Description

Displays the value of a LwM2M object, object instance, or resource.

30.1.8.2 Syntax

| Type | Syntax | Response | Example |
|------|---------------------|---------------------------|---|
| Set | AT+ULWM2MREAD=<URI> | +ULWM2MREAD: <JSON> OK | AT+ULWM2MREAD="/1/1/1" +ULWM2MREAD: {"bn":"/1/1/1","e":[{"n":"1","v":1000}]} OK |
| Test | AT+ULWM2MREAD=? | +ULWM2MREAD: "URI" OK | +ULWM2MREAD: "URI" OK |

30.1.8.3 Defined values

| Parameter | Type | Description |
|-----------|--------|---|
| <URI> | String | Uniform Resource Identifier (URI) to existing object |
| <JSON> | String | JSON-formatted LwM2M resource or object instance; for more details, Lightweight Machine to Machine Technical Specification [198]. The maximum length is: <ul style="list-style-type: none"> SARA-R4 - 1024 characters If the returned JSON length exceeds the parameter maximum length an error result code is issued. |

30.1.8.4 Notes

SARA-R410M-63B / SARA-R410M-73B / SARA-R410M-83B

- The command `AT+ULWM2MREAD="/0"` is not allowed in order not to disclose some security parameters.
- In case of error only the "ERROR" final result code is returned.

SARA-R410M-02B / SARA-R412M

- The command is not supported by SARA-R410M-02B-00, SARA-R410M-02B-01, SARA-R410M-02B-02, SARA-R412M-02B-00, SARA-R412M-02B-01, SARA-R412M-02B-02.
- In case of error only the "ERROR" final result code is returned.

30.2 LwM2M connectivity

30.2.1 SARA-R4 Command line and information text response maximum length for LwM2M connectivity features

The maximum length of the command line and the maximum length of the information text response is:

- SARA-R410M-02B / SARA-R410M-63B / SARA-R410M-73B / SARA-R410M-83B / SARA-R412M / SARA-R422 / SARA-R422M8S / SARA-R422S - 1040 characters
- SARA-R404M / SARA-R410M-01B / SARA-R410M-52B - 500 characters



SARA-R410M-02B / SARA-R412M

On SARA-R410M-02B-00, SARA-R410M-02B-01, SARA-R410M-02B-02, SARA-R412M-02B-00, SARA-R412M-02B-01, SARA-R412M-02B-02 the maximum length of the command line and the maximum length of the information text response is 500 characters.

30.2.2 LwM2M URCs configuration +ULWM2MSTAT

| +ULWM2MSTAT | | | | | | |
|-------------|--------------|--------------|----------------|----------------|---------------|-----------------|
| Modules | All products | | | | | |
| Attributes | Syntax | PIN required | Settings saved | Can be aborted | Response time | Error reference |
| | full | No | NVM | No | - | +CME Error |

30.2.2.1 SARA-R410M-02B / SARA-R410M-63B / SARA-R410M-73B / SARA-R410M-83B / SARA-R412M / SARA-R422 / SARA-R422M8S / SARA-R422S Description



SARA-R410M-02B / SARA-R412M

For the command description for SARA-R410M-02B-00, SARA-R410M-02B-01, SARA-R410M-02B-02, SARA-R412M-02B-00, SARA-R412M-02B-01, SARA-R412M-02B-02, see the [Chapter 30.2.2.4](#).

Configures the URC reporting status for LwM2M client. The URC assumes a different syntax and meaning depending on the reported <event> value and it may be related to a specific LwM2M server (e.g. <event>=1). According to the <event> parameter value a URC can be issued:

- **<event>=0 (bootstrap status):** for each phase of the factory bootstrap procedure
- **<event>=1 (registration status):** when a LwM2M server changes the state of its registration
- **<event>=2 (remaining time until the next registration update):** to periodically show the remaining time (in seconds) before the next registration update towards each LwM2M server
- **<event>=3 (notification):** when a LwM2M notification is sent from the LwM2M client to the LwM2M server during a valid observation
- **<event>=4 (LwM2M client status):** when the overall state of the LwM2M client changes
- **<event>=5 (LwM2M client initialization status):** for each phase of the initialization of the LwM2M client
- **<event>=6 (LwM2M server connection status):** when a connection with a LwM2M server starts/stops/pauses/resumes

30.2.2.2 SARA-R410M-02B / SARA-R410M-63B / SARA-R410M-73B / SARA-R410M-83B / SARA-R412M / SARA-R422 / SARA-R422M8S / SARA-R422S Syntax



SARA-R410M-02B / SARA-R412M

For the syntax supported by SARA-R410M-02B-00, SARA-R410M-02B-01, SARA-R410M-02B-02, SARA-R412M-02B-00, SARA-R412M-02B-01, SARA-R412M-02B-02, see the [Chapter 30.2.2.5](#).

| Type | Syntax | Response | Example |
|--|--------------------------------------|---|---|
| Set | AT+ULWM2MSTAT=<n>[,<verbosity_mask>] | OK | AT+ULWM2MSTAT=1,1 OK |
| Read | AT+ULWM2MSTAT? | +ULWM2MSTAT: <n>,<verbosity_mask> OK | +ULWM2MSTAT: 1,1 OK |
| Test | AT+ULWM2MSTAT=? | +ULWM2MSTAT: (list of supported <n>s),(list of supported <verbosity_mask>s) OK | +ULWM2MSTAT: (0,1),(1-7) OK |
| Generic syntax | | | |
| URC | | +ULWM2MSTAT: <event>,<param1>[,<param2>[,<param3>[,<param4>]]] | +ULWM2MSTAT: 1,721,2 |
| Bootstrap status | | | |
| URC | | +ULWM2MSTAT: 0,<server_id>,<status> | +ULWM2MSTAT: 0,721,2 |
| Registration status | | | |
| URC | | +ULWM2MSTAT: 1,<server_id>,<status> | +ULWM2MSTAT: 1,721,2 |
| Registration interval | | | |
| URC | | +ULWM2MSTAT: 2,<server_id>,<reg_update_timer> | +ULWM2MSTAT: 2,721,10 |
| Notification | | | |
| URC | | +ULWM2MSTAT: 3,<server_id>,<URI> | +ULWM2MSTAT: 3,123,"/3300/0/5700" |
| LwM2M client status | | | |
| URC | | +ULWM2MSTAT: 4,<client_status> | +ULWM2MSTAT: 4,7 |
| LwM2M client initialization status | | | |
| URC | | +ULWM2MSTAT: 5,<client_init_status> | +ULWM2MSTAT: 5,1 |
| LwM2M server connection status generic syntax | | | |
| URC | | +ULWM2MSTAT: 6,<server_id>,<server_connection_status>,<param3>[,<param4>] | +ULWM2MSTAT: 6,721,0,"leshan.eclipseprojects.io:5684" |
| LwM2M server connection created | | | |
| URC | | +ULWM2MSTAT: 6,<server_id>,0,<server_address> | +ULWM2MSTAT: 6,721,0,"leshan.eclipseprojects.io:5684" |

| Type | Syntax | Response | Example |
|--|--------|--|---|
| LwM2M server connection suspended | | | |
| URC | | +ULWM2MSTAT: 6,<server_id>,1,<sent_data>,<received_data> | +ULWM2MSTAT: 6,721,1,1254,4588 |
| LwM2M server connection resumed | | | |
| URC | | +ULWM2MSTAT: 6,<server_id>,2,<server_address> | +ULWM2MSTAT: 6,721,2,"leshan.eclipseprojects.io:5684" |
| LwM2M server connection closed | | | |
| URC | | +ULWM2MSTAT: 6,<server_id>,3,<sent_data>,<received_data> | +ULWM2MSTAT: 6,721,3,2365,5699 |

30.2.2.3 SARA-R410M-02B / SARA-R410M-63B / SARA-R410M-73B / SARA-R410M-83B / SARA-R412M / SARA-R422 / SARA-R422M8S / SARA-R422S Defined values



SARA-R410M-02B / SARA-R412M

For the parameters description of SARA-R410M-02B-00, SARA-R410M-02B-01, SARA-R410M-02B-02, SARA-R412M-02B-00, SARA-R412M-02B-01, SARA-R412M-02B-02, see the [Chapter 30.2.2.6](#).

| Parameter | Type | Description |
|------------------|--------|--|
| <n> | Number | Enables and disables the +ULWM2MSTAT URC: <ul style="list-style-type: none"> 0: LwM2M status URC disabled 1: LwM2M status +ULWM2MSTAT URC enabled The factory-programmed value is: <ul style="list-style-type: none"> SARA-R410M-02B / SARA-R412M / SARA-R422 / SARA-R422M8S / SARA-R422S - 0 SARA-R410M-63B / SARA-R410M-73B / SARA-R410M-83B - 1 |
| <verbosity_mask> | Number | Optional parameter, represents a bitmask. It enables different levels of verbosity in +ULWM2MSTAT URC: <ul style="list-style-type: none"> bit 0: enables reporting of <event>s from 0 to 4 bit 1: enables reporting of <event>: 5 bit 2: enables reporting of <event>: 6 The factory-programmed value is 1 (only bit 0 enabled) |
| <event> | Number | Event type: <ul style="list-style-type: none"> 0: bootstrap status 1: registration status 2: remaining time until the next registration update 3: notification. A notify message has been triggered as per Lightweight Machine to Machine Technical Specification [198] 4: LwM2M client status 5: LwM2M client initialization status 6: LwM2M server connection status |
| <server_id> | Number | Short server ID corresponding to a server defined by object 1 resource 0. |
| <status> | Number | Status code corresponding to the server state. Allowed values: <ul style="list-style-type: none"> SARA-R410M-02B / SARA-R412M / SARA-R422 / SARA-R422M8S / SARA-R422S <ul style="list-style-type: none"> 0: deregistered 1: registration hold 2: registration pending 3: registration success 4: registration failed 5: registration update pending 6: registration update needed 7: registration full update needed 8: deregistration needed 9: deregistration pending 10: bootstrap hold off 11: bootstrap initiated 12: bootstrap pending 13: bootstrap finishing 14: bootstrap finished |

| Parameter | Type | Description |
|----------------------------|------------------|---|
| | | <ul style="list-style-type: none"> o 15: bootstrap failing o 16: bootstrap failed • SARA-R410M-63B / SARA-R410M-73B / SARA-R410M-83B <ul style="list-style-type: none"> o 0: deregistered o 1: registration pending o 2: registration success o 3: registration failed o 4: registration update pending o 5: registration update needed o 6: registration full update needed o 7: deregistration needed o 8: deregistration pending o 9: bootstrap hold off o 10: bootstrap initiated o 11: bootstrap pending o 12: bootstrap finishing o 13: bootstrap finished o 14: bootstrap failing o 15: bootstrap failed |
| <reg_update_timer> | Number | Time in seconds until the next registration update. |
| <URI> | String | Uniform Resource Identifier (URI) to existing object |
| <client_status> | Number | LwM2M client status: <ul style="list-style-type: none"> • 0: initial • 1: bootstrap required • 2: bootstrapping • 3: registration required • 4: registering • 5: ready • 6: command mode only. No server communication occurs. • 7: client shut down |
| <client_init_status> | Number | LwM2M client initialization status: <ul style="list-style-type: none"> • 1: initialization started • 2: initialization finished • 3: client start aborted due to production mode |
| <server_connection_status> | Number | LwM2M server connection status: <ul style="list-style-type: none"> • 0: connection created; <param3> is the <server_address> • 1: connection idle; <param3> is <sent_data> and <param4> is the <received_data> • 2: connection restored; <param3> is the <server_address> • 3: connection closed; <param3> is <sent_data> and <param4> is the <received_data> |
| <server_address> | String | LwM2M server address, corresponding to the resource 0 of the Security Object, in the format "host:port". |
| <sent_data> | Number | Amount of data sent (at the CoAP level) to the LwM2M server so far on this logical connection. |
| <received_data> | Number | Amount of data received (at the CoAP level) from the LwM2M server so far on this logical connection. |
| <param1> | Number | The content depends on the related <event> (details are given above). |
| <param2> | String | Content and type depend on the related <event> (details are given above). |
| <param3> | Number or String | The content depends on the related <event> (details are given above). |
| <param4> | Number | The content depends on the related <event> (details are given above). |

30.2.2.4 SARA-R404M / SARA-R410M-01B / SARA-R410M-02B / SARA-R410M-52B / SARA-R412M / SARA-N4 Description



SARA-R410M-02B / SARA-R412M

The following command description is applicable to SARA-R410M-02B-00, SARA-R410M-02B-01, SARA-R410M-02B-02, SARA-R412M-02B-00, SARA-R412M-02B-01, SARA-R412M-02B-02.

Allows enabling or disabling of LwM2M FOTA status URCs.

30.2.2.5 SARA-R404M / SARA-R410M-01B / SARA-R410M-02B / SARA-R410M-52B / SARA-R412M / SARA-N4 Syntax



SARA-R410M-02B / SARA-R412M

The following syntax is supported by SARA-R410M-02B-00, SARA-R410M-02B-01, SARA-R410M-02B-02, SARA-R412M-02B-00, SARA-R412M-02B-01, SARA-R412M-02B-02.

| Type | Syntax | Response | Example |
|--------------------------------|-------------------|---|--------------------------|
| Set | AT+ULWM2MSTAT=<n> | OK | AT+ULWM2MSTAT=1 OK |
| Read | AT+ULWM2MSTAT? | +ULWM2MSTAT: <n> OK | +ULWM2MSTAT: 1 OK |
| Test | AT+ULWM2MSTAT=? | +ULWM2MSTAT: (list of supported <n>s) OK | +ULWM2MSTAT: (0,1) OK |
| Generic syntax | | | |
| URC | | +ULWM2MSTAT: <stat>,<param_val> | +ULWM2MSTAT: 1,5 |
| FOTA download triggered | | | |
| URC | | +ULWM2MSTAT: 0,0 | +ULWM2MSTAT: 1,99 |
| FOTA download progress | | | |
| URC | | +ULWM2MSTAT: 1,<percent> | +ULWM2MSTAT: 1,99 |
| FOTA download completed | | | |
| URC | | +ULWM2MSTAT: 2,100 | +ULWM2MSTAT: 2,100 |
| FOTA download error | | | |
| URC | | +ULWM2MSTAT: 3,<error_code> | +ULWM2MSTAT: 3,103 |

30.2.2.6 SARA-R404M / SARA-R410M-01B / SARA-R410M-02B / SARA-R410M-52B / SARA-R412M / SARA-N4 Defined values



SARA-R410M-02B / SARA-R412M

The following parameters definitions are applicable to SARA-R410M-02B-00, SARA-R410M-02B-01, SARA-R410M-02B-02, SARA-R412M-02B-00, SARA-R412M-02B-01, SARA-R412M-02B-02.

| Parameter | Type | Description |
|--------------|--------|---|
| <n> | Number | Enables and disables reporting events as a result of a FOTA download: <ul style="list-style-type: none"> 0: disables reporting of LwM2M FOTA downloading state via URC 1 (factory-programmed value): enables reporting of LwM2M FOTA downloading state via URC |
| <stat> | Number | Provides the states during a LwM2M FOTA download: <ul style="list-style-type: none"> 0: FOTA download triggered 1: FOTA download in progress 2: FOTA download complete 3: FOTA download error |
| <percent> | Number | Percentage of FOTA download completed |
| <error_code> | Number | Error codes: <ul style="list-style-type: none"> 0: error 100: user cancelled 101: memory error 102: network error 103: unknown error while communicating with network 104: bad URL result Allowed values: <ul style="list-style-type: none"> SARA-R410M-02B / SARA-R410M-52B / SARA-R412M / SARA-N4 - 100, 101, 102, 103, 104 SARA-R404M / SARA-R410M-01B - 0 |
| <param_val> | Number | The supported content depends on the related <stat> parameter. Details are given above. |

30.2.2.7 Notes

SARA-N4

- In case of error only the "ERROR" final result code is returned.

SARA-R410M / SARA-R412M

- The <verbosity_mask>, <client_init_status>, <server_connection_status>, <server_address>, <sent_data>, <received_data> parameters as well as <event>=5 (LwM2M client initialization status) and 6 (LwM2M server connection status) are not supported.
- In case of error only the "ERROR" final result code is returned.

SARA-R422 / SARA-R422M8S / SARA-R422S

- <client_init_status>=3 (start aborted due to production mode) is not supported.
- <server_connection_status>=1 (connection idle) and <server_connection_status>=2 (connection restored) are not supported.
- In case of error only the "ERROR" final result code is returned.

30.2.3 Activate/deactivate LwM2M client +ULWM2M

| +ULWM2M | | | | | | |
|------------|--------------|--------------|----------------|----------------|---------------|-----------------|
| Modules | All products | | | | | |
| Attributes | Syntax | PIN required | Settings saved | Can be aborted | Response time | Error reference |
| | full | Yes | NVM | No | - | +CME Error |

30.2.3.1 SARA-R410M-02B / SARA-R410M-63B / SARA-R410M-73B / SARA-R410M-83B / SARA-R412M / SARA-R422 / SARA-R422M8S / SARA-R422S Description



SARA-R410M-02B / SARA-R412M

For the command description for SARA-R410M-02B-00, SARA-R410M-02B-01, SARA-R410M-02B-02, SARA-R412M-02B-00, SARA-R412M-02B-01, SARA-R412M-02B-02, see the [Chapter 30.2.3.4](#).

Activates or deactivates the LwM2M client.

After issuing the AT+ULWM2M=1 (stop the LwM2M client) command or the AT+ULWM2M=2 (reset the LwM2M client) command, the LwM2M features and the FOTA updates are not available.

The AT+ULWM2M=2 command erases the LwM2M object database; it has no effect on the NVM settings regarding LwM2M activation/deactivation.



SARA-R410M / SARA-R412M

To reactivate the client, reboot the module by means of [AT+CFUN=15](#) command.



SARA-R422 / SARA-R422M8S / SARA-R422S

- The AT+ULWM2M=1 (stop/disable the LwM2M client) or AT+ULWM2M=0 (start/enables the LwM2M client) commands save the <activation_mode> parameter in NVM.
- If the GCF-PTCRB (<MNO>=201) profile is selected (see the [+UMNOPROF](#) AT command), the LwM2M client is disabled. Otherwise, if one of the other MNO profile is selected, and <activation_mode>=0, the LwM2M client is enabled at boot.
- It is possible to query the <activation_mode> NVM setting (can be 0 or 1) by issuing the read command.
- After issuing the AT+ULWM2M=1 (stop the LwM2M client) command, reboot the module (e.g. by means of [AT+CFUN=16](#)) to make the setting effective.



SARA-R410M-63B

After issuing AT+ULWM2M=3 (communication with NTT DoCoMo servers disabled) LwM2M features and the FOTA updates are not available; issue AT+ULWM2M=4 (communication with NTT DoCoMo servers enabled) to re-activate the client.

Select the NTT DoCoMo profile by means of the [+UMNOPROF](#) AT command before enabling (<activation_mode>=4) or disabling (<activation_mode>=3) the communication with NTT DoCoMo servers.

30.2.3.2 SARA-R410M-02B / SARA-R410M-63B / SARA-R410M-73B / SARA-R410M-83B / SARA-R412M / SARA-R422 / SARA-R422M8S / SARA-R422S Syntax



SARA-R410M-02B / SARA-R412M

For the syntax supported by SARA-R410M-02B-00, SARA-R410M-02B-01, SARA-R410M-02B-02, SARA-R412M-02B-00, SARA-R412M-02B-01, SARA-R412M-02B-02, see the [Chapter 30.2.3.5](#).

| Type | Syntax | Response | Example |
|------|-----------------------------|---|----------------------|
| Set | AT+ULWM2M=<activation_mode> | OK | AT+ULWM2M=1 OK |
| Read | AT+ULWM2M? | +ULWM2M: <activation_mode> OK | +ULWM2M: 1 OK |
| Test | AT+ULWM2M=? | +ULWM2M: (list of supported <activation_mode>s) OK | +ULWM2M: (1-2) OK |

30.2.3.3 SARA-R410M-02B / SARA-R410M-63B / SARA-R410M-73B / SARA-R410M-83B / SARA-R412M / SARA-R422 / SARA-R422M8S / SARA-R422S Defined values

SARA-R410M-02B / SARA-R412M

For the parameters description of SARA-R410M-02B-00, SARA-R410M-02B-01, SARA-R410M-02B-02, SARA-R412M-02B-00, SARA-R412M-02B-01, SARA-R412M-02B-02, see the [Chapter 30.2.3.6](#).

| Parameter | Type | Description |
|-------------------|--------|--|
| <activation_mode> | Number | Operation type: <ul style="list-style-type: none"> 0: activates and enables the LwM2M client 1: stops or disables the LwM2M client 2: reset the LwM2M client (erases the LwM2M object database) 3: communication with NTT DoCoMo servers disabled 4: communication with NTT DoCoMo servers enabled Allowed values: <ul style="list-style-type: none"> SARA-R422 / SARA-R422M8S / SARA-R422S - 0 (factory-programmed value), 1, 2 SARA-R410M-02B / SARA-R410M-73B / SARA-R410M-83B / SARA-R412M - 1, 2 SARA-R410M-63B - 1, 2, 3 (factory-programmed value), 4 |

30.2.3.4 SARA-R404M / SARA-R410M-01B / SARA-R410M-02B / SARA-R410M-52B / SARA-R412M / SARA-N4 Description

SARA-R410M-02B / SARA-R412M

The following command description is applicable to SARA-R410M-02B-00, SARA-R410M-02B-01, SARA-R410M-02B-02, SARA-R412M-02B-00, SARA-R412M-02B-01, SARA-R412M-02B-02.

Cancels the FW download to the device when a LwM2M session is in progress. To make use of this command, enable URCs for LwM2M FOTA sessions. For more details on enabling LwM2M URCs, see [+ULWM2MSTAT](#).

30.2.3.5 SARA-R404M / SARA-R410M-01B / SARA-R410M-02B / SARA-R410M-52B / SARA-R412M / SARA-N4 Syntax

SARA-R410M-02B / SARA-R412M

The following syntax is supported by SARA-R410M-02B-00, SARA-R410M-02B-01, SARA-R410M-02B-02, SARA-R412M-02B-00, SARA-R412M-02B-01, SARA-R412M-02B-02.

| Type | Syntax | Response | Example |
|------|-----------------------------|---|----------------------|
| Set | AT+ULWM2M=<activation_mode> | OK | AT+ULWM2M=0 OK |
| Test | AT+ULWM2M=? | +ULWM2M: (list of supported <activation_mode>s) OK | +ULWM2M: (0-2) OK |

30.2.3.6 SARA-R404M / SARA-R410M-01B / SARA-R410M-02B / SARA-R410M-52B / SARA-R412M / SARA-N4 Defined values

SARA-R410M-02B / SARA-R412M

The following parameters definitions are applicable to SARA-R410M-02B-00, SARA-R410M-02B-01, SARA-R410M-02B-02, SARA-R412M-02B-00, SARA-R412M-02B-01, SARA-R412M-02B-02.

| Parameter | Type | Description |
|-------------------|--------|---|
| <activation_mode> | Number | Allowed value: <ul style="list-style-type: none"> 0: abort LwM2M FOTA download |

30.2.3.7 Notes

SARA-R404M / SARA-R410M-01B / SARA-R410M-02B / SARA-R410M-52B / SARA-R410M-73B / SARA-R410M-83B / SARA-R412M / SARA-N4

- The command setting is not stored in the NVM.
- The read command is not supported.
- In case of error only the "ERROR" final result code is returned.

SARA-R410M-63B

- The read command is not supported.
- <activation_mode>=1 is not persistent across power cycles.
- In case of error only the "ERROR" final result code is returned.

30.2.4 Initiate LwM2M server registration +ULWM2MREG

| +ULWM2MREG | | | | | | |
|------------|--|--------------|----------------|----------------|---------------|----------------------------|
| Modules | SARA-R410M-02B SARA-R410M-63B SARA-R410M-73B SARA-R410M-83B SARA-R412M SARA-R422 SARA-R422M8S SARA-R422S | | | | | |
| Attributes | Syntax | PIN required | Settings saved | Can be aborted | Response time | Error reference |
| | full | No | No / OP | No | - | +CME Error |

30.2.4.1 Description

Forces the bootstrap or the registration for a specific LwM2M server.

30.2.4.2 Syntax

| Type | Syntax | Response | Example |
|------|--------------------------|--|-------------------------------|
| Set | AT+ULWM2MREG=<server_id> | OK | AT+ULWM2MREG=123 OK |
| Read | AT+ULWM2MREG? | +ULWM2MREG: <server_id>, <server_status>[,<registration_interval>] OK | +ULWM2MREG: 721,2,175 OK |
| Test | AT+ULWM2MREG=? | +ULWM2MREG: (0, list of supported <server_id>s) OK | +ULWM2MREG: (0,721,123) OK |

30.2.4.3 Defined values

| Parameter | Type | Description |
|-----------------|--------|--|
| <server_id> | Number | Short server ID corresponding to a server defined by object 1 resource 0 |
| <server_status> | Number | Status code corresponding to the server state. Allowed values: <ul style="list-style-type: none"> SARA-R410M-02B / SARA-R412M / SARA-R422 / SARA-R422M8S / SARA-R422S <ul style="list-style-type: none"> 0: deregistered 1: registration hold 2: registration pending 3: registration success 4: registration failed 5: registration update pending 6: registration update needed 7: registration full update needed 8: deregistration needed 9: deregistration pending 10: bootstrap hold off 11: bootstrap initiated 12: bootstrap pending 13: bootstrap finishing |

| Parameter | Type | Description |
|-------------------------|--------|---|
| | | <ul style="list-style-type: none"> o 14: bootstrap finished o 15: bootstrap failing o 16: bootstrap failed • SARA-R410M-63B / SARA-R410M-73B / SARA-R410M-83B <ul style="list-style-type: none"> o 0: deregistered o 1: registration pending o 2: registration success o 3: registration failed o 4: registration update pending o 5: registration update needed o 6: registration full update needed o 7: deregistration needed o 8: deregistration pending o 9: bootstrap hold off o 10: bootstrap initiated o 11: bootstrap pending o 12: bootstrap finishing o 13: bootstrap finished o 14: bootstrap failing o 15: bootstrap failed |
| <registration_interval> | Number | For successfully registered servers (see the <server_status> parameter) this is the number of seconds until the next registration update |

30.2.4.4 Notes

SARA-R422 / SARA-R422M8S / SARA-R422S

- The set command returns immediately the "OK" final result code and the LwM2M registration procedure to the target set server is scheduled and executed later. The registration is confirmed by [+ULWM2MSTAT](#) URC, where the <reg_update_timer> parameter is expected to increment after a successful server registration.

SARA-R410M-02B / SARA-R412M

- The command is not supported by SARA-R410M-02B-00, SARA-R410M-02B-01, SARA-R410M-02B-02, SARA-R412M-02B-00, SARA-R412M-02B-01, SARA-R412M-02B-02.
- The set command returns immediately OK and the LwM2M registration procedure to the target set server is scheduled and executed later. The registration is confirmed by [+ULWM2MSTAT](#) URC, where the <reg_update_timer> is expected to increment after a successful server registration.
- In case of error only the "ERROR" final result code is returned.

SARA-R410M-63B / SARA-R410M-73B / SARA-R410M-83B

- The set command returns immediately the "OK" final result code and the LwM2M registration procedure to the target set server is scheduled and executed later. The registration is confirmed by [+ULWM2MSTAT](#) URC, where the <reg_update_timer> parameter is expected to increment after a successful server registration.
- In case of error only the "ERROR" final result code is returned.

30.2.5 LwM2M server deregistration +ULWM2MDEREG

| +ULWM2MDEREG | | | | | | |
|-------------------|--|---------------------|-----------------------|-----------------------|----------------------|----------------------------|
| Modules | SARA-R410M-02B SARA-R410M-63B SARA-R410M-73B SARA-R410M-83B SARA-R412M SARA-R422 SARA-R422M8S SARA-R422S | | | | | |
| Attributes | Syntax | PIN required | Settings saved | Can be aborted | Response time | Error reference |
| | full | No | No | No | - | +CME Error |

30.2.5.1 Description

Forces a deregistration for a specific LwM2M server or for all servers by means of the <server_id> parameter.

Issue a test command to retrieve the list of the available server IDs.

30.2.5.2 Syntax

| Type | Syntax | Response | Example |
|------|----------------------------|--|-----------------------------|
| Set | AT+ULWM2MDEREG=<server_id> | OK | AT+ULWM2MDEREG=0 OK |
| Test | AT+ULWM2MDEREG=? | +ULWM2MDEREG: (0,list of supported <server_id>s) OK | +ULWM2MDEREG: (0,721) OK |

30.2.5.3 Defined values

| Parameter | Type | Description |
|-------------|--------|---|
| <server_id> | Number | Short server ID corresponding to a server defined by object 1 resource 0. The special value 0 means deregister all servers. |

30.2.5.4 Notes

SARA-R422 / SARA-R422M8S / SARA-R422S

- The set command returns immediately the "OK" final result code and the LwM2M deregistration procedure to the target set server is scheduled and executed later. The deregistration is confirmed by the [+ULWM2MSTAT](#) URC, where the <status>=0 parameter confirms a successful server deregistration.

SARA-R410M-02B / SARA-R412M

- The command is not supported by SARA-R410M-02B-00, SARA-R410M-02B-01, SARA-R410M-02B-02, SARA-R412M-02B-00, SARA-R412M-02B-01, SARA-R412M-02B-02.
- The set command returns immediately the "OK" final result code and the LwM2M deregistration procedure to the target set server is scheduled and executed later. The deregistration is confirmed by the [+ULWM2MSTAT](#) URC, where the <status>=0 parameter confirms a successful server deregistration.
- In case of error only the "ERROR" final result code is returned.

SARA-R410M-63B / SARA-R410M-73B / SARA-R410M-83B

- The set command returns immediately the "OK" final result code and the LwM2M deregistration procedure to the target set server is scheduled and executed later. The deregistration is confirmed by the [+ULWM2MSTAT](#) URC, where the <status>=0 parameter confirms a successful server deregistration.
- In case of error only the "ERROR" final result code is returned.

30.2.6 LwM2M server configuration +ULWM2MCONFIG

| +ULWM2MCONFIG | | | | | | |
|-------------------|--|---------------------|-----------------------|-----------------------|----------------------|----------------------------|
| Modules | SARA-R410M-02B SARA-R410M-63B SARA-R410M-73B SARA-R410M-83B SARA-R412M SARA-R422 SARA-R422M8S SARA-R422S | | | | | |
| Attributes | Syntax | PIN required | Settings saved | Can be aborted | Response time | Error reference |
| | full | No | No / OP | No | - | +CME Error |

30.2.6.1 Description

Configures connection parameters for a LwM2M server. It can be used to edit existing configurations or to define configurations for additional servers. This command allows specifying parameters used during a server connection and LwM2M client behavior in case of a registration failure.

The information text response to the read command provides the configuration of LwM2M servers connection parameters in separate rows.



SARA-R410M-63B / SARA-R410M-73B / SARA-R410M-83B / SARA-R422M8S / SARA-R422S

The LwM2M client cannot register with the LwM2M server if the connection requires the use of the pre-shared key (PSK) generated by the root of trust (<usec_psk>=1) and the secure data suite features on the module are disabled ([+USECMODE: 0](#)). If enabled, the [+ULWM2MSTAT](#) URC will report the registration failure.



SARA-R410M-63B / SARA-R410M-73B / SARA-R410M-83B

On SARA-R410M-63B-00, SARA-R410M-73B-00, SARA-R410M-83B-00, the LwM2M client cannot register with the LwM2M server if the connection requires the use of the pre-shared key (PSK) generated by the root of trust (<usec_psk>=1) and the secure data suite features on the module are disabled ([+USECOFF: 1](#)). If enabled, the [+ULWM2MSTAT](#) URC will report the registration failure.



Allowed values of <server_id> depends on the selected mobile network operator profile (for more details, see the [+UMNOPROF](#) AT command). For the list of available servers in each mobile network operator profile, refer to the [+ULWM2MREG](#) AT command row of the proper mobile network operator table in [Mobile network operator profiles](#).

30.2.6.2 Syntax

| Type | Syntax | Response | Example |
|------|--|--|--|
| Set | AT+ULWM2MCONFIG= <server_id>, <bootstrap_on_failure>, <pdn_ip_type>, <cid>, <usec_psk>, <reg_update_boot>, <dtls_session_resumption>, <full_registration_after_fota>, <DTLS_NAT_timer>, <reg_upd_at_PSM_exit>, <reg_upd_after_DTLS_handshake>, <server_disabled> | OK | AT+ULWM2MCONFIG=721,0,2,1,1,0,0,0,40,0,0,0 OK |
| Read | AT+ULWM2MCONFIG? | +ULWM2MCONFIG: <server_id>, <bootstrap_on_failure>, <pdn_ip_type>, <cid>, <usec_psk>, <reg_update_boot>, <dtls_session_resumption>, <full_registration_after_fota>, <DTLS_NAT_timer>, <reg_upd_at_PSM_exit>, <reg_upd_after_DTLS_handshake>, <server_disabled> [...] OK | +ULWM2MCONFIG: 721,0,2,1,1,0,0,0,40,0,0,0 +ULWM2MCONFIG: 123,0,1,1,0,0,0,0,40,0,0,0 OK |
| Test | AT+ULWM2MCONFIG=? | +ULWM2MCONFIG: (list of supported <server_id>s), (list of supported <bootstrap_on_failure>s), (list of supported <pdn_ip_type>s), (list of supported <cid>s), (list of supported <usec_psk>s), (list of supported <reg_update_boot>s), (list of supported <dtls_session_resumption>s), (list of supported <full_registration_after_fota>s), (list of supported <DTLS_NAT_timer>s), (list of supported <reg_upd_at_PSM_exit>s), (list of supported <reg_upd_after_DTLS_handshake>s), (list of supported <server_disabled>s) OK | +ULWM2MCONFIG: (1-65535),(0-1),(1-3),(1-8),(0-1),(0-1),(0-1),(0-86400),(0-1),(0-2),(0-2) OK |

30.2.6.3 Defined values

| Parameter | Type | Description |
|------------------------|--------|--|
| <server_id> | Number | Short server ID corresponding to a server defined by object 1 resource 0 |
| <bootstrap_on_failure> | Number | Enable/disable a bootstrap attempt after a failed registration. Allowed values: <ul style="list-style-type: none"> 0: disable a bootstrap attempt after a failed registration 1: enable a bootstrap attempt after a failed registration |
| <pdn_ip_type> | Number | Packet data network (PDN) type. Allowed values: <ul style="list-style-type: none"> 1: IPv4 2: IPv6 3: IPv4v6 |
| <cid> | Number | See <cid> . |
| <usec_psk> | Number | Use the pre-shared key (PSK) generated by the root of trust. Allowed values: <ul style="list-style-type: none"> 0: disabled 1: enabled For more details on data and device security features, see Data and device security . |
| <reg_update_boot> | Number | Force a registration update with the LwM2M server after a reboot. Allowed values: |

| Parameter | Type | Description |
|--------------------------------|--------|--|
| | | <ul style="list-style-type: none"> 0: disabled 1: enabled |
| <dtls_session_resumption> | Number | Enable the DTLS session resumption. For more details, see RFC 7925 [182]. Allowed values: <ul style="list-style-type: none"> 0: disabled 1: enabled |
| <full_registration_after_fota> | Number | Force a full registration with the LwM2M server after a FOTA has been performed. Allowed values: <ul style="list-style-type: none"> 0: disabled 1: enabled |
| <DTLS_NAT_timer> | Number | Timeout (in seconds) representing the network address translation (NAT) timer for LwM2M DTLS session re-handshake. Timer is restarted after any LwM2M packet is sent or received; if it times out, the next delivery will cause a DTLS handshake. The range goes from 0 to 86400. |
| <reg_upd_at_PSM_exit> | Number | Force a full registration with the LwM2M server when module turns ON as a result of PSM exit. Allowed values: <ul style="list-style-type: none"> 0: disabled 1: enabled |
| <reg_upd_after_DTLS_handshake> | Number | Force a registration update in the case a new DTLS handshake is performed. Allowed values: <ul style="list-style-type: none"> 0: always disabled 1: always enabled 2: enabled only during FOTA |
| <server_disabled> | Number | When disabled, LwM2M client communication to the server is prevented: it will not perform registration updates and no data to the server will be sent. Allowed values: <ul style="list-style-type: none"> 0: always enabled 1: always disabled 2: disabled only in roaming cell condition |

30.2.6.4 Notes

SARA-R4

- The command settings are stored in internal files, one for each MNO profile. If the MNO profile is changed via the **+UMNOPROF** AT command, no change to the settings stored in the file will occur but the corresponding file will be selected.
- The **<reg_update_boot>**, **<dtls_session_resumption>**, **<full_registration_after_fota>**, **<DTLS_NAT_timer>**, **<reg_upd_at_PSM_exit>**, **<reg_upd_after_DTLS_handshake>** and **<server_disabled>** parameters are not supported.

SARA-R422M8S / SARA-R422S

- The **<cid>** parameter is not effective.

SARA-R422

- The **<cid>** parameter is not effective.
- The **<usec_psk>** parameter is not effective.

SARA-R410M-63B / SARA-R410M-73B / SARA-R410M-83B

- In case of error only the "ERROR" final result code is returned.

SARA-R410M-02B / SARA-R412M

- The command is not supported by SARA-R410M-02B-00, SARA-R410M-02B-01, SARA-R410M-02B-02, SARA-R412M-02B-00, SARA-R412M-02B-01, SARA-R412M-02B-02.
- The **<usec_psk>** parameter is not effective.
- In case of error only the "ERROR" final result code is returned.

30.2.7 LwM2M host device information +UHOSTDEV

| +UHOSTDEV | | | | | | |
|-------------------|---|---------------------|-----------------------|-----------------------|----------------------|----------------------------|
| Modules | SARA-R410M-01B SARA-R410M-02B SARA-R410M-52B SARA-R412M SARA-N4 | | | | | |
| Attributes | Syntax | PIN required | Settings saved | Can be aborted | Response time | Error reference |
| | full | Yes | NVM | No | - | +CME Error |

30.2.7.1 Description

Sets the host identification, manufacturer model number and software version for the LwM2M device management.

30.2.7.2 Syntax

| Type | Syntax | Response | Example |
|------|--|---|---|
| Set | AT+UHOSTDEV=<Host_ID>,<Host_Manufacturer>,<Host_Model>,<Host_SW_Version> | OK | AT+UHOSTDEV="ubx123456-","u-blox","C030-R410","A1.01" OK |
| Read | AT+UHOSTDEV? | +UHOSTDEV: <Host_ID>,<Host_Manufacturer>,<Host_Model>,<Host_SW_Version> OK | +UHOSTDEV: "ubx123456-","u-blox","C030-R410","A1.01" OK |
| Test | AT+UHOSTDEV=? | +UHOSTDEV: (Host ID),(Host Manufacturer),(Host Model),(Host Software Version) OK | +UHOSTDEV: (Host ID),(Host Manufacturer),(Host Model),(Host Software Version) OK |

30.2.7.3 Defined values

| Parameter | Type | Description |
|---------------------|--------|--|
| <Host_ID> | String | Host identification. The factory-programmed value is "HMAN0". |
| <Host_Manufacturer> | String | Host manufacturer name. The factory-programmed value is "HMOD0". |
| <Host_Model> | String | Host model identification. The factory-programmed value is "HSW0". |
| <Host_SW_Version> | String | Host software version. The factory-programmed value is "HUID0". |

30.2.8 Lightweight M2M pulse configuration +ULWM2MPULSE

| +ULWM2MPULSE | | | | | | |
|-------------------|--|---------------------|-----------------------|-----------------------|----------------------|----------------------------|
| Modules | SARA-R410M-02B SARA-R410M-63B SARA-R410M-73B SARA-R410M-83B SARA-R412M SARA-R422 SARA-R422M8S SARA-R422S | | | | | |
| Attributes | Syntax | PIN required | Settings saved | Can be aborted | Response time | Error reference |
| | full | No | NVM | No | - | +CME Error |

30.2.8.1 Description

Configures the LwM2M pulse feature that allows the sending of a LwM2M generated pulse. The LwM2M pulse can be properly configured both for the duration and for the polarity.

The information text response to the read command provides the configuration of GPIO pins set to LwM2M pulse feature in separate rows.



Properly configure the GPIO function to the LwM2M pulse mode by means of the [+UGPIOC](#) AT command (<gpio_mode>=25).



The LwM2M pulse is generated by calling the `lua_send_pulse(gpio_id)` function from the Lua scripts; for more details on the trigger definition, see the LwM2M objects and commands application note [\[56\]](#). The LwM2M pulse feature can be triggered by the LwM2M server and also by the [+ULWM2MCREATE](#), [+ULWM2MWRITE](#), [+ULWM2MDELETE](#), [+ULWM2MREAD](#) AT commands.

30.2.8.2 Syntax

| Type | Syntax | Response | Example |
|------|--|---|---|
| Set | AT+ULWM2MPULSE=<gpio_id>,<active_polarity>,<duration>,<boot_with_last_event> | OK | AT+ULWM2MPULSE=16,1,100,0 OK |
| Read | AT+ULWM2MPULSE? | +ULWM2MPULSE: <gpio_id>,<gpio_mode>,<active_polarity>,<duration>,<boot_with_last_event> [...] OK | +ULWM2MPULSE: 16,25,0,5000,1 19,25,0,5000,1 23,25,0,5000,1 24,25,0,5000,1 25,25,0,5000,1 42,25,0,5000,1 OK |
| Test | AT+ULWM2MPULSE=? | +ULWM2MPULSE: (list of supported <gpio_id>s),(list of supported <active_polarity>s),(list of supported <duration>s),(list of supported <boot_with_last_event>s) OK | +ULWM2MPULSE: (16,19,23,24,25,42),(0-1),(0-10000),(0-1) OK |

30.2.8.3 Defined values

| Parameter | Type | Description |
|------------------------|--------|---|
| <gpio_id> | Number | GPIO pin identifier: pin number. See the GPIO mapping for the available GPIO pins, their mapping and factory-programmed values on different u-blox cellular modules series and product version. |
| <gpio_mode> | Number | GPIO mode identifier: configured function. Allowed value: <ul style="list-style-type: none"> 25: LwM2M pulse |
| <active_polarity> | Number | Allowed values: <ul style="list-style-type: none"> 0: active low (i.e., normally high) 1: active high (i.e., normally low) |
| <duration> | Number | Provide the pulse duration expressed in milliseconds. The range goes from 0 to 10000 where 0 means to be left asserted. |
| <boot_with_last_event> | Number | Configures the pulse behaviour at the module power-on. Allowed values: <ul style="list-style-type: none"> 0: always negated 1: comes up asserted or negated according to last state at power down/reset |

30.2.8.4 Notes

SARA-R410M-02B / SARA-R412M

- The command is not supported by SARA-R410M-02B-00, SARA-R410M-02B-01, SARA-R410M-02B-02, SARA-R412M-02B-00, SARA-R412M-02B-01, SARA-R412M-02B-02.

30.2.9 LwM2M object notification +ULWM2MNOTIFY

| +ULWM2MNOTIFY | | | | | | |
|---------------|--|--------------|----------------|----------------|---------------|-----------------|
| Modules | SARA-R410M-02B SARA-R410M-63B SARA-R410M-73B SARA-R410M-83B SARA-R412M SARA-R422 SARA-R422M8S SARA-R422S | | | | | |
| Attributes | Syntax | PIN required | Settings saved | Can be aborted | Response time | Error reference |
| | full | No | NVM | No | - | - |

30.2.9.1 Description

Enables or disables the +ULWM2MNOTIFY URC defined in the Lua objects. The trigger which determines when the +ULWM2MNOTIFY URC is issued and the returned message string are custom, according to the object Lua script definition; for more details on the URC definition, see the LwM2M objects and commands application note [56]. The +ULWM2MNOTIFY URC can be triggered by the [+ULWM2MCREATE](#), [+ULWM2MWRITE](#), [+ULWM2MDELETE](#), [+ULWM2MREAD](#) AT commands.

30.2.9.2 Syntax

| Type | Syntax | Response | Example |
|------|--------------------------|--|--|
| Set | AT+ULWM2MNOTIFY=<enable> | OK | AT+ULWM2MNOTIFY=1 OK |
| Read | AT+ULWM2MNOTIFY? | +ULWM2MNOTIFY: <enable> | +ULWM2MNOTIFY: 0 OK |
| Test | AT+ULWM2MNOTIFY=? | +ULWM2MNOTIFY: (list of supported <enable>s) OK | +ULWM2MNOTIFY: (0,1) OK |
| URC | | +ULWM2MNOTIFY: <LwM2M_Lua_string> | +ULWM2MNOTIFY: write to resource 5750, value Accelerometer |

30.2.9.3 Defined values

| Parameter | Type | Description |
|--------------------|--------|--|
| <enable> | Number | Allowed values: <ul style="list-style-type: none"> 0: +ULWM2MNOTIFY URC disabled 1: +ULWM2MNOTIFY URC enabled The factory-programmed value is: <ul style="list-style-type: none"> SARA-R4 - 1 |
| <LwM2M_Lua_string> | String | String as passed to the Lua API function lua_send_urc(), called from the Lua scripts. |

30.2.9.4 Notes

SARA-R4

- The <LwM2M_Lua_string> maximum length is 128 characters.

SARA-R410M-02B / SARA-R412M

- The command is not supported by SARA-R410M-02B-00, SARA-R410M-02B-01, SARA-R410M-02B-02, SARA-R412M-02B-00, SARA-R412M-02B-01, SARA-R412M-02B-02.

30.2.10 LwM2M host device information +ODIS

| +ODIS | | | | | | |
|------------|---------------------------|--------------|----------------|----------------|---------------|-----------------|
| Modules | SARA-R410M-02B SARA-R412M | | | | | |
| Attributes | Syntax | PIN required | Settings saved | Can be aborted | Response time | Error reference |
| | full | Yes | No | No | - | +CME Error |

30.2.10.1 Description

Sets the host identification, manufacturer, model number and software version for the LwM2M device management. If the current MNO profile is not set to AT&T (+UMNOPROF: 2), AT&T 2-4-12 (+UMNOPROF: 198) or FirstNet (+UMNOPROF: 206) and the command is issued, the module returns an error result code.

Upon the command execution the new setting is saved in a file in the file system and is persistent across power cycles.

30.2.10.2 Syntax

| Type | Syntax | Response | Example |
|------|--|---|---|
| Set | AT+ODIS=<Host_Device_ID>,<Host_Device_Manufacturer>,<Host_Device_Model>,<Host_Device_Software_Version> | OK | AT+ODIS="ubx123456-","u-blox","C030-R510","A1.01" OK |
| Read | AT+ODIS? | +ODIS: <Host_Device_Manufacturer>,<Host_Device_Model>,<Host_Device_Software_Version> OK | +ODIS: "u-blox","C030-R510","A1.01" OK |
| Test | AT+ODIS=? | +ODIS: (Host Device ID),(Host Device Manufacturer),(Host Device Model),(Host Device Software Version) OK | +ODIS: (Host Device ID),(Host Device Manufacturer),(Host Device Model),(Host Device Software Version) |

| Type | Syntax | Response | Example |
|------|--------|----------|---------|
| | | OK | OK |

30.2.10.3 Defined values

| Parameter | Type | Description |
|--------------------------------|--------|---|
| <Host_Device_ID> | String | Host identification. The factory-programmed value is "HUID0". |
| <Host_Device_Manufacturer> | String | Host manufacturer name. The factory-programmed value is "HMAN0". |
| <Host_Device_Model> | String | Host model identification. The factory-programmed value is "HMOD0". |
| <Host_Device_Software_Version> | String | Host software version. The factory-programmed value is "HSW0". |

30.2.10.4 Notes

SARA-R410M-02B / SARA-R412M

- The command is not supported by SARA-R410M-02B-00, SARA-R410M-02B-01, SARA-R410M-02B-02, SARA-R412M-02B-00, SARA-R412M-02B-01, SARA-R412M-02B-02.

A Appendix: Error result codes

A.1 Mobile termination error result codes +CME ERROR

| Numeric error code | Description |
|--------------------|---|
| 0 | Phone failure |
| 1 | No connection to phone |
| 2 | Phone-adaptor link reserved |
| 3 | Operation not allowed |
| 4 | Operation not supported |
| 5 | PH-SIM PIN required |
| 6 | PH-FSIM PIN required |
| 7 | PH-FSIM PUK required |
| 10 | SIM not inserted |
| 11 | SIM PIN required |
| 12 | SIM PUK required |
| 13 | SIM failure |
| 14 | SIM busy |
| 15 | SIM wrong |
| 16 | Incorrect password |
| 17 | SIM PIN2 required |
| 18 | SIM PUK2 required |
| 20 | Memory full |
| 21 | Invalid index |
| 22 | Network not found |
| 23 | Memory failure |
| 24 | Text string too long |
| 25 | Invalid characters in text string |
| 26 | Dial string too long |
| 27 | Invalid characters in dial string |
| 30 | No network service |
| 31 | Network timeout |
| 32 | Network not allowed - emergency calls only |
| 40 | Network personalisation PIN required |
| 41 | Network personalisation PUK required |
| 42 | Network subset personalisation PIN required |
| 43 | Network subset personalisation PUK required |
| 44 | Service provider personalisation PIN required |
| 45 | Service provider personalisation PUK required |
| 46 | Corporate personalisation PIN required |
| 47 | Corporate personalisation PUK required |
| 50 | Incorrect parameters |
| 51 | Command implemented but currently disabled |
| 52 | Command aborted by user |
| 53 | Not attached to network due to MT functionality restrictions |
| 54 | Modem not allowed - MT restricted to emergency calls only |
| 55 | Operation not allowed because of MT functionality restrictions |
| 56 | Fixed dial number only allowed - called number is not a fixed dial number |
| 57 | Temporarily out of service due to other MT usage |
| 100 | Unknown |
| 103 | Illegal MS |
| 106 | Illegal ME |
| 107 | GPRS services not allowed |
| 108 | GPRS and non GPRS services not allowed |

| Numeric error code | Description |
|---------------------------|---|
| 111 | PLMN not allowed |
| 112 | Location area not allowed |
| 113 | Roaming not allowed in this location area |
| 114 | GPRS services not allowed in this PLMN |
| 115 | No Suitable Cells In Location Area |
| 122 | Congestion |
| 125 | Not authorized for this CSG |
| 126 | Insufficient resources |
| 127 | Missing or unknown APN |
| 128 | Unknown PDP address or PDP type |
| 129 | User authentication failed |
| 130 | Request rejected by Serving GW or PDN GW |
| 131 | Request rejected, unspecified |
| 132 | Service option not supported |
| 133 | Requested service option not subscribed |
| 134 | Service option temporarily out of order |
| 135 | NS-api already used |
| 137 | EPS QoS not accepted |
| 138 | Network failure |
| 140 | Feature not supported |
| 141 | Semantic error in the TFT operation |
| 142 | Syntactical error in the TFT operation |
| 143 | Unknown PDP context |
| 144 | Semantic errors in packet filter(s) |
| 145 | Syntactical errors in packet filter(s) |
| 146 | PDP context without TFT already activated |
| 147 | PTI mismatch |
| 148 | Unspecified GPRS error |
| 149 | PDP authentication failure |
| 150 | Invalid mobile class |
| 153 | ESM information not received |
| 154 | PDN connection does not exist |
| 155 | Multiple PDN connections for a given APN not allowed |
| 156 | User Busy |
| 159 | Uplink Busy/ Flow Control |
| 160 | Bearer handling not supported |
| 165 | Maximum number of EPS bearers reached |
| 166 | Requested APN not supported in current RAT and PLMN combination |
| 168 | Network failure |
| 169 | IMSI unknown in VLR |
| 170 | Congestion |
| 171 | Last PDN disconnection not allowed |
| 172 | Semantically incorrect message |
| 173 | Mandatory information element error |
| 174 | Information element non-existent or not implemented |
| 175 | Conditional IE error |
| 176 | Protocol error, unspecified |
| 177 | Operator determined barring |
| 178 | Maximum number of PDP contexts reached |
| 179 | Requested APN not supported in current RAT and PLMN combination |
| 180 | Request rejected, bearer control mode violation |
| 181 | Invalid PTI value |
| 189 | Semantically incorrect message |
| 190 | Invalid mandatory IE |
| 191 | Message type non existent |

| Numeric error code | Description |
|---------------------------|---|
| 192 | Message type not compatible |
| 193 | IE non existent |
| 194 | Conditional IE error |
| 195 | Message not compatible |
| 197 | Protocol error unspecified |
| 254 | Invalid error mapping |
| 255 | Internal error |
| 262 | SIM blocked |
| 300 | ME failure |
| 301 | SMS service of ME reserved |
| 302 | Operation not allowed |
| 303 | Operation not supported |
| 304 | Invalid PDU mode parameter |
| 305 | Invalid text mode parameter |
| 310 | (U)SIM not inserted |
| 311 | (U)SIM PIN required |
| 312 | PH-(U)SIM PIN required |
| 313 | (U)SIM failure |
| 314 | (U)SIM busy |
| 315 | (U)SIM wrong |
| 316 | (U)SIM PUK required |
| 317 | (U)SIM PIN2 required |
| 318 | (U)SIM PUK2 required |
| 320 | Memory failure |
| 321 | Invalid memory index |
| 322 | Memory full |
| 330 | SMSC address unknown |
| 331 | No network service |
| 332 | Network timeout |
| 340 | No +CNMA acknowledgement expected |
| 500 | Unknown error |
| 608 | Voice call active |
| 701 | Incorrect security code |
| 702 | Max attempts reached |
| 1001 | Unassigned (unallocated) number |
| 1003 | No route to destination |
| 1006 | Channel unacceptable |
| 1008 | Operator determined barring |
| 1016 | Normal call clearing |
| 1017 | User busy |
| 1018 | No user responding |
| 1019 | User alerting, no answer |
| 1021 | Call rejected |
| 1022 | Number changed |
| 1026 | Non selected user clearing |
| 1027 | Destination out of order |
| 1028 | Invalid number format (incomplete number) |
| 1029 | Facility rejected |
| 1030 | Response to STATUS ENQUIRY |
| 1031 | Normal, unspecified |
| 1034 | No circuit/channel available |
| 1038 | Network out of order |
| 1041 | Temporary failure |
| 1042 | Switching equipment congestion |
| 1043 | Access information discarded |

| Numeric error code | Description |
|---------------------------|--|
| 1044 | requested circuit/channel not available |
| 1047 | Resources unavailable, unspecified |
| 1049 | Quality of service unavailable |
| 1050 | Requested facility not subscribed |
| 1055 | Incoming calls barred within the CUG |
| 1056 | Collision with network initiated request |
| 1057 | Bearer capability not authorized |
| 1058 | Bearer capability not presently available |
| 1059 | Unsupported QCI value |
| 1063 | Service or option not available, unspecified |
| 1065 | Bearer service not implemented |
| 1068 | ACM equal to or greater than ACMmax |
| 1069 | Requested facility not implemented |
| 1070 | Only restricted digital information bearer capability is available |
| 1079 | Service or option not implemented, unspecified |
| 1081 | Invalid transaction identifier value |
| 1087 | User not member of CUG |
| 1088 | Incompatible destination |
| 1091 | Invalid transit network selection |
| 1095 | Semantically incorrect message |
| 1096 | Invalid mandatory information |
| 1097 | Message type non-existent or not implemented |
| 1098 | Message type not compatible with protocol state |
| 1099 | Information element non-existent or not implemented |
| 1100 | Conditional IE error |
| 1101 | Message not compatible with protocol state |
| 1102 | Recovery on timer expiry |
| 1111 | Protocol error, unspecified |
| 1112 | APN restriction value incompatible with active EPS bearer context |
| 1127 | Interworking, unspecified |
| 1142 | Network Error |
| 1143 | Invalid EPS bearer identity |
| 1149 | Last PDN disconnection not allowed |
| 1243 | Emm Error Unspecified |
| 1244 | Esm Error Unspecified |
| 1279 | Number not allowed |
| 1283 | CCBS possible |
| 1500 | Wrong GPIO identifier |
| 1501 | Set GPIO default error |
| 1502 | Select GPIO mode error |
| 1503 | Read GPIO error |
| 1504 | Write GPIO error |
| 1505 | GPIO busy |
| 1520 | Wrong ADC identifier |
| 1521 | Read ADC error |
| 1530 | IPv4 only allowed |
| 1531 | IPv6 only allowed |
| 1540 | Wrong ringer identifier |
| 1542 | LLC or SNDCCP failure |
| 1543 | Regular deactivation |
| 1544 | Reactivation requested |
| 1545 | Single address bearers only allowed |
| 1546 | Invalid transaction identifier value |
| 1547 | APN restriction val incompatible with PDP context |
| 1548 | PDP activation rejected |

| Numeric error code | Description |
|---------------------------|---|
| 1549 | unknown PDP address or PDP type |
| 1550 | GPRS generic operation error |
| 1551 | GPRS invalid APN |
| 1552 | GPRS authentication failure |
| 1553 | GPRS QoS parameters inconsistent |
| 1554 | GPRS network failure |
| 1555 | GPRS context busy |
| 1556 | CSD generic operation error |
| 1557 | CSD undefined profile |
| 1558 | CSD context busy |
| 1559 | PLMN scan not allowed |
| 1600 | FFS error |
| 1560 | PDP type IPv4 only allowed |
| 1561 | PDP type IPv6 only allowed |
| 1612 | FILE NOT FOUND |
| 1613 | Cannot open file |
| 1614 | TAC value not allowed |
| 1615 | OTP failure |
| 1616 | Wrong Check Digit |
| 1620 | Buffer full |
| 1621 | FFS initializing |
| 1622 | FFS already open file |
| 1623 | FFS not open file |
| 1624 | FFS file not found |
| 1625 | FFS file already created |
| 1626 | FFS illegal id |
| 1627 | FFS illegal file handle |
| 1628 | FFS illegal type |
| 1629 | FFS illegal mode |
| 1630 | FFS file range |
| 1631 | FFS operation not possible |
| 1632 | FFS write error |
| 1633 | FFS user id error |
| 1634 | FFS internal fatal error |
| 1635 | FFS memory resource error |
| 1636 | FFS maximum number of files exceeded |
| 1637 | FFS memory not available |
| 1638 | FFS invalid filename |
| 1639 | FFS streaming not enabled |
| 1640 | FFS operation not allowed on static file |
| 1641 | FFS memory table inconsistency |
| 1642 | FFS not a factory default file |
| 1643 | FFS requested memory temporary not available |
| 1644 | FFS operation not allowed for a directory |
| 1645 | FFS directory space not available |
| 1646 | FFS too many streaming files open |
| 1647 | FFS requested dynamic memory temporary not available |
| 1648 | FFS user provided a NULL parameter instead of a suitable buffer |
| 1649 | FFS timeout |
| 1650 | Command line too long |
| 1660 | Call barred - Fixed dialing numbers only |
| 1670 | SEC remote object wrong state |
| 1671 | SEC ROT not personalized |
| 1672 | SEC loss of connectivity |
| 1673 | SEC service not authorized |

| Numeric error code | Description |
|--------------------|---|
| 1674 | SEC FW package installation required |
| 1675 | SEC FW package not valid |
| 1676 | SEC resource not available |
| 1677 | SEC data not available |
| 1678 | SEC timeout |
| 1679 | SEC data inconsistent or unsupported |
| 1680 | SEC pspk lock pending |
| 1681 | SEC C2C already paired |
| 1682 | SEC C2C channels consumed |
| 1683 | SEC C2C pairing not present |
| 1684 | SEC busy |
| 1685 | SEC connection failed due to a DNS resolution error |
| 1686 | SEC RoT has been restored and a resync operation is pending |
| 1700 | GPS GPIO not configured |
| 1701 | GPS GPIO ownership error |
| 1702 | Invalid operation with GPS ON |
| 1703 | Invalid operation with GPS OFF |
| 1704 | Invalid GPS aiding mode |
| 1705 | Reserved GPS aiding mode |
| 1706 | GPS aiding mode already set |
| 1707 | Invalid GPS trace mode |
| 1708 | Parameter valid only in case of GPS OTA |
| 1709 | GPS trace invalid server |
| 1710 | Invalid TimeZone |
| 1711 | Invalid value |
| 1712 | Invalid parameter |
| 1713 | Invalid operation with LOC running / GPS Busy |
| 1800 | No ongoing call |
| 1801 | IBM busy / eCall already armed/active |
| 1802 | IBM feature off / eCall feature off |
| 1803 | Wrong IBM requested |
| 1804 | Audio resource not available |
| 1805 | ECALL restriction |
| 1806 | eCall invalid dial number |
| 1900 | No SAP Server Connection |
| 1901 | SAP Protocol Error |
| 1902 | SAP Connection failure |
| 1903 | SAP Server Disconnection |
| 1904 | SAP Other terminal using service |
| 1910 | USECMNG import timeout expired (no input for > 20 s) |
| 1911 | USECMNG import file size exceeds limit |
| 1912 | USECMNG no memory available |
| 1913 | USECMNG invalid certificate/key format |
| 1914 | USECMNG database full |
| 1950 | CDC-ECM is not available |
| 1951 | CDC-ECM is busy |
| 1952 | No DHCP Packets received from the DTE |
| 2000 | Command timeout |
| 3000 | Command aborted |
| 4000 | APN configuration mismatch |
| 4001 | IP type configuration mismatch |
| 5000 | FOTA package download state or name mismatch |
| 5001 | FOTA package data corrupted |
| 5002 | FOTA memory is in use |

A.2 Message service error result codes +CMS ERROR

| Numeric error code | Description |
|--------------------|--|
| 1 | Unassigned (unallocated) number |
| 5 | Delta firmware unavailable on FOTA server |
| 8 | Operator determined barring |
| 10 | Call barred |
| 17 | Network failure |
| 21 | Short message transfer rejected |
| 22 | Memory capacity exceeded |
| 27 | Destination out of service |
| 28 | Unidentified subscriber |
| 29 | Facility rejected |
| 30 | Unknown Subscriber |
| 38 | Network out of order |
| 41 | Temporary failure |
| 42 | Congestion |
| 47 | Resources unavailable, unspecified |
| 50 | Requested facility not subscribed |
| 69 | Requested facility not implemented |
| 81 | Invalid short message reference value |
| 95 | Invalid message, unspecified |
| 96 | invalid mandatory information |
| 97 | Message type non-existent or not implemented |
| 98 | Message not compatible with short message protocol state |
| 99 | Information element non-existent or not implemented |
| 111 | Protocol error, unspecified |
| 127 | Interworking, unspecified |
| 128 | Telematic interworking not supported |
| 129 | Short message type 0 not supported |
| 130 | Cannot replace short message |
| 143 | Unspecified TP-PID error |
| 144 | Data coding scheme (alphabet) not supported |
| 145 | Message class not supported |
| 159 | Unspecified TP-DCS error |
| 160 | Command cannot be actioned |
| 161 | Command unsupported |
| 175 | Unspecified TP-Command error |
| 176 | TPDU not supported |
| 192 | SC busy |
| 193 | No SC subscription |
| 194 | SC system failure |
| 195 | Invalid SME address |
| 196 | Destination SME barred |
| 197 | SM Rejected-Duplicate SM |
| 198 | TP-VPF not supported |
| 199 | TP-VP not supported |
| 208 | SIM SMS storage full |
| 209 | No SMS storage capability in SIM |
| 210 | Error in MS |
| 211 | Memory Capacity Exceeded |
| 212 | SIM Application Toolkit Busy |
| 213 | SIM data download error |
| 287 | Network failure unspecified |
| 290 | Network no resource |
| 296 | Radio Resources not Available due to DUAL SIM operation |

| Numeric error code | Description |
|---------------------------|--|
| 297 | Out of service due to DUAL SIM operation |
| 300 | ME failure |
| 301 | SMS service of ME reserved |
| 302 | Operation not allowed |
| 303 | operation not supported |
| 304 | Invalid PDU mode parameter |
| 305 | Invalid Text mode parameter |
| 310 | SIM not inserted |
| 311 | SIM PIN required |
| 312 | PH-SIM PIN required |
| 313 | SIM failure |
| 314 | SIM busy |
| 315 | SIM wrong |
| 320 | memory failure |
| 321 | invalid memory index |
| 322 | memory full |
| 330 | SMSC address unknown |
| 331 | no network service |
| 332 | network timeout |
| 340 | no +CNMA acknowledgement expected |
| 350 | Unassigned (unallocated) number |
| 351 | Operator determined barring |
| 352 | Call barred |
| 353 | ME failure |
| 354 | Short message transfer rejected |
| 355 | Number changed |
| 356 | Destination out of order |
| 357 | Unidentified subscriber |
| 358 | Facility rejected |
| 359 | Unknown subscriber |
| 364 | Requested facility not subscribed |
| 365 | Requested facility not implemented |
| 368 | Invalid mandatory information |
| 369 | Message type non-existent or not implemented |
| 370 | Message not compatible with short message protocol state |
| 371 | Information element non-existent or not implemented |
| 372 | Protocol error, unspecified |
| 373 | Interworking, unspecified |
| 360 | Network out of order |
| 361 | Temporary failure |
| 362 | Congestion |
| 363 | Resources unavailable, unspecified |
| 366 | Invalid short message transfer reference value |
| 367 | Invalid message, unspecified |
| 500 | unknown error |
| 512 | Relay Protocol Acknowledgement |
| 513 | SMS timer expired |
| 514 | SMS forwarding availability failed |
| 515 | SMS forwarding availability aborted |
| 516 | MS invalid TP-Message-Type-Indicator |
| 517 | MS no TP-Status-Report in Phase 1 |
| 518 | MS no TP-Reject-Duplicate in phase 1 |
| 519 | MS no TP-Replay-Path in Phase 1 |
| 520 | MS no TP-User-Data-Header in Phase 1 |
| 521 | MS missing TP-Validity-Period |

| Numeric error code | Description |
|---------------------------|--|
| 522 | MS invalid TP-Service-Centre-Time-Stamp |
| 523 | MS missing TP-Destination-Address |
| 524 | MS invalid TP-Destination-Address |
| 525 | MS missing Service-Centre-Address |
| 526 | MS invalid Service-Centre-Address |
| 527 | MS invalid alphabet |
| 528 | MS invalid TP-User-Data-length |
| 529 | MS missing TP-User-Data |
| 530 | MS TP-User-Data too long |
| 531 | MS no Command-Request in Phase 1 |
| 532 | MS Cmd-Req invalid TP-Destination-Address |
| 533 | MS Cmd-Req invalid TP-User-Data-Length |
| 534 | MS Cmd-Req invalid TP-User-Data |
| 535 | MS Cmd-Req invalid TP-Command-Type |
| 536 | MN MNR creation failed |
| 537 | MS CMM creation failed |
| 538 | MS network connection lost |
| 539 | MS pending MO SM transfer |
| 540 | RP-Error OK |
| 541 | RP-Error OK no icon display |
| 542 | SMS-PP Unspecified |
| 543 | SMS rejected By SMS CONTROL |
| 543 | FDN check failed |
| 544 | Service Centre Address(SCA) FDN failed |
| 545 | Destination Address(DA) FDN failed |
| 546 | BDN check failed |
| 547 | Unspecified SMS PP error |
| 548 | Undefined Result |
| 548 | No Route To Destination |
| 549 | Channel Unacceptable |
| 555 | No Circuit/Channel Available |
| 556 | Access Information Discarded |
| 557 | Requested Circuit/Channel Not Available By Other Side |
| 558 | Quality Of Service Unavailable |
| 560 | Bearer Capability Not Authorized |
| 561 | Bearer Capability Not Presently Available |
| 562 | Service or Option Not Available, Unspecified |
| 563 | Bearer Service Not Implemented |
| 564 | ACM Equal to or Greater Than ACMmax |
| 565 | Only Restricted Digital Information Bearer Capability Is Available |
| 566 | Service or Option Not Implemented, Unspecified |
| 567 | User Not Member of CUG |
| 568 | Incompatible By Destination |
| 569 | Invalid Transit Network Selection |
| 571 | Message Not Compatible With Protocol State |
| 572 | Recovery On Timer Expiry |
| 576 | Data Call Active |
| 577 | Speech Call Active |
| 579 | MOC Setup Rejected Due to Missing ACM Info |
| 580 | Temporary Forbidden Call Attempt |
| 581 | Called Party is Blacklisted |
| 583 | Temporary Forbidden Call Attempt No Service |
| 584 | Temporary Forbidden Call Attempt Limited Service |
| 585 | Client Temporary Barred |
| 586 | Dual Service Call Active |

| Numeric error code | Description |
|--------------------|--|
| 587 | Atc Fclass Not Speech |
| 590 | Client Not Registered |
| 591 | Active Client Gone |
| 595 | Rejected By Call Control |
| 601 | Invalid ALS Line |
| 604 | MM No Service (out of coverage) |
| 605 | MM Access Class Barred (RR_REL_IND During RR Conn. Establishment) |
| 606 | ME Busy -CM Service Request Already Pending |
| 608 | Rejected Due To SUP Timer Expiry |
| 609 | Rejected Due To USSD Busy |
| 610 | Rejected Due To SS Busy |
| 612 | SIM Toolkit Request Is Rejected, Because Another SIM Toolkit Request Is Pending |
| 614 | Rejected Because SIM Toolkit Request Is Not Yet Answered By The User |
| 615 | MN Setup SS Error |
| 616 | Call Controller Blocked (Other Call Command Pending) |
| 618 | Environment Parameter Not Set Correctly (Fclass/Cmod) |
| 619 | Other Blocking Call Present |
| 620 | Lower Layer Failure |
| 621 | The Authentication Procedure Failed |
| 622 | The Packet-Switched Registration Procedure Failed |
| 623 | CM Service Reject From The Network |
| 624 | The ABORT Message Was Received From The Network |
| 625 | Timer Expiry |
| 626 | IMSI Deatch Was Initiated |
| 627 | Normal RR Connection Release (2G) |
| 628 | Registration Failed |
| 630 | Failure Due To Handover |
| 631 | Link Establishment Failure |
| 632 | Random Access Failure |
| 633 | Radio Link Aborted |
| 634 | Lower Layer Failure in Layer 1 |
| 635 | Immediate Assignment Reject |
| 636 | Failure Due To Paging |
| 637 | Abnormal Release Unspecified |
| 638 | Abnormal Release Channel Unacceptable |
| 639 | Abnormal Release Timer Expired |
| 640 | Abnormal Release No Act On Radio Path |
| 641 | Preemptive Release |
| 642 | UTRAN Configuration Unknown |
| 643 | Handover Impossible |
| 644 | Channel Mode Unacceptable |
| 647 | Lower Layer Failure From NW |
| 649 | Conditional IE Error |
| 650 | No Cell Allocation Available |
| 653 | Re Establishment Reject |
| 654 | Directed Sigconn Re Establishment |
| 656 | Release of RRC connection Witout Network Activity(3G) Lower Layer Failure Downlink |
| 657 | Lower Layer Failure Uplink |
| 658 | Cell Barred Due To Authentication Failure |
| 659 | Signalling Connection Release |
| 660 | CS Connection Release Triggered By MM |
| 661 | RRC Connection Establishment Failure |
| 662 | RRC Connection Establsihment Reject With Redirection |

| Numeric error code | Description |
|--------------------|---|
| 663 | Resource Conflict |
| 664 | Lower Layer Failure in Layer 2 |
| 665 | L2 Cause T200 Expiry N200 Plus 1 Times |
| 669 | RR Connection Release Due to BAND Change (2G) |
| 670 | Release of the RRC Connection Due to Out of Service in Cell_Fach (3G) |
| 671 | Release of the RRC Connection Due to Not Matching PLMN in Shared Networks(3G) |
| 672 | Error Happens While Call Is Already Disconnected / Late Error |
| 674 | SIM Toolkit Cannot Initiate A Call, Because MMI Is Not Registered |
| 675 | SIM Toolkit Call Setup Request Is Rejected Due User Did Not Accept |
| 676 | Proactive SIM Appl Terminated By User |
| 677 | SIM Toolkit Originated SIM Reset (Refresh Request) |
| 680 | Dial String/Number Incorrect |

A.3 Firmware install final result codes

The **+UFWINSTALL** command issues a final result code providing the result of the FW install procedure. In case the FW install procedure fails, the error result code provides some indication about the error cause (syntax error or issue during the installation procedure).

A.3.1 SARA-R4 / SARA-N4 final result codes from command syntax

Syntax error resulting from the **+UFWINSTALL** command:

| Numeric code | error Verbose description | Description |
|--------------|--------------------------------|--|
| 4 | +CME ERROR: not supported | One of the following cases: <ul style="list-style-type: none"> • Wrong serial port number • Wrong baud rate • Number of parameters not allowed • Filename too long |
| 1624 | +CME ERROR: FFS file not found | The delta file is not stored in the module FS or the filename is wrong |

A.3.1.1 SARA-R4 / SARA-N4 final result codes from end of update procedure

 SARA-R404M / SARA-R410M / SARA-R412M / SARA-N4
No error codes are generated.

A.3.1.1.1 SARA-R422 / SARA-R422M8S / SARA-R422S final result codes table

Here below are listed the allowed final result codes that can be issued at the finalization of the install procedure by means of the **+UFWINSTALL** AT command.

| Error result code | Description | URC UART port and baud rate |
|-------------------|---|-----------------------------------|
| 128 | Firmware install successfully performed | Set by +UFWINSTALL |
| 129 | Firmware install generic failure | Set by +UFWINSTALL |
| 130 | Flash access failure | Default: Primary UART, 115200 b/s |
| 131 | RAM allocation error | Default: Primary UART, 115200 b/s |
| 132 | Retrieve partition table error | Default: Primary UART, 115200 b/s |
| 134 | Bad Block Flash initialization failure | Set by +UFWINSTALL |
| 140 | Generic decompression engine error | Set by +UFWINSTALL |
| 141 | RAM error | Set by +UFWINSTALL |
| 144 | Requested file does not exist during installation (it could be a working file/partition in flash or FW file/partition to be updated. It could be a flash error) | Set by +UFWINSTALL |
| 145 | Attempt to do file operation when file system access is not available | Set by +UFWINSTALL |
| 148 | Delta file is corrupted | Set by +UFWINSTALL |
| 158 | Delta file not recognized. It happens trying to update from a non-delta file format | Set by +UFWINSTALL |
| 160 | Flash writing failure | Set by +UFWINSTALL |

| Error result code | Description | URC UART port and baud rate |
|-------------------|---|------------------------------------|
| 168 | Source firmware in flash mismatch with the one expected by the delta file. | Set by +UFWINSTALL |
| 173 | Calculated digital signature does not match package header value - probably wrong signature or some byte corrupted | Set by +UFWINSTALL |
| 174 | Delta file version is not supported | Set by +UFWINSTALL |
| 178 | RAM memory corruption (Null Pointer assignment) | Set by +UFWINSTALL |
| 180 | Size of the delta file in flash mismatch with the real delta file size | Set by +UFWINSTALL |
| 195 | Data corruption found in a component/partition/file updated in flash. Probably cause by power loss cause or flash problem | Set by +UFWINSTALL |
| 224 | Generic error in finalizing the end of the install procedure. Last check before exiting install. | Set by +UFWINSTALL |
| 227 | FOTA public key is not found or invalid | Set by +UFWINSTALL |
| 230 | File operation (write/read/delete) in flash fail | Set by +UFWINSTALL |
| 247 | Pre-validation of the delta file failed | Set by +UFWINSTALL |

A.4 FOAT error result codes

See [+UFWUPD](#) command description.

A.4.1 SARA-R422 / SARA-R422M8S / SARA-R422S error result codes

| Error result code | Description |
|----------------------------|--|
| ERROR1 | The operation has been interrupted and the actual FW is unchanged; the module drops out from Firmware Update Mode |
| ERROR2 | The operation has been interrupted during FW updating; the actual firmware is corrupted and the module remains in Firmware Update Mode |
| ERROR3 | The signature check fails |
| ERROR4 | The module has received unexpected EOT because not all expected bytes have been received |
| ERROR5 | The boot does not support the selected baudrate |
| ERROR6 | Invalid AT command sent during boot |
| FLS header decoding failed | An error occurs during decoding of file header |
| Buffer Data Overrun | The buffers are not filled at least with a 1029 packet: data comes too slowly |
| Timeout | The command must be re-sent: no data is coming |

A.4.2 SARA-R422 / SARA-R422M8S / SARA-R422S extended error result codes

Here below are listed the allowed final result codes that can be issued at the finalization of the install procedure by means of the [+UFWUPD](#) command:

- 128: FW update successfully performed
- In case a different error result code is provided please contact u-blox Technical Support offices for support

A.4.3 SARA-R404M / SARA-R410M / SARA-R412M / SARA-N4 error result codes

No error codes are generated.

A.5 Dynamic DNS unsolicited indication codes

The following table lists the available values of <error_code> parameter of the last Dynamic DNS update provided through [+UUDYNDNS](#) URC (for more details, see the [+UDYNDNS](#) AT command description).

| Numeric error code | Description |
|--------------------|--|
| 0 | Success |
| 1 | Data connection lost while performing update |

| Numeric error code | Description |
|--------------------|--|
| 2 | Cannot update dynamic DNS because a private IP address has been assigned to the module |
| 3 | Connection to dynamic DNS server failed |
| 4 | Error occurred sending data to dynamic DNS server |
| 5 | Error occurred reading response from dynamic DNS server |
| 6 | Timeout while waiting response from dynamic DNS server |
| 7 | Dynamic DNS server closed connection unexpectedly |
| 8 | Unexpected response from dynamic DNS server |
| 9 | Dynamic DNS response seems to be incomplete |
| 10 | Update has been delayed in order to respect DNS update protocol timing specification |
| 40 | Dynamic DNS protocol specific: good (TZO code 200) |
| 41 | Dynamic DNS protocol specific: nochg (TZO code 304) |
| 42 | Dynamic DNS protocol specific: notfqdn |
| 43 | Dynamic DNS protocol specific: nohost |
| 44 | Dynamic DNS protocol specific: numhost |
| 45 | Dynamic DNS protocol specific: badauth (TZO code 401) |
| 46 | Dynamic DNS protocol specific: badagent (TZO code 405) |
| 47 | Dynamic DNS protocol specific: !donator |
| 48 | Dynamic DNS protocol specific: abuse |
| 49 | Dynamic DNS protocol specific: dnserr |
| 50 | Dynamic DNS protocol specific: 911 |
| 51 | Dynamic DNS protocol specific: badsys |
| 52 | Dynamic DNS protocol specific: !yours |
| 53 | Dynamic DNS protocol specific: TZO code 403 |
| 54 | Dynamic DNS protocol specific: TZO code 407 |
| 55 | Dynamic DNS protocol specific: TZO code 414 |
| 56 | Dynamic DNS protocol specific: TZO code 415 |
| 57 | Dynamic DNS protocol specific: TZO code 480 |
| 100-108 | Internal errors |

 The meaning of dynamic DNS protocol specific codes depends on the provider used; see the provider documentation.

 Errors 45, 46, 53, 54 and 56 trigger a client self deactivation when the provider is TZO.com.

 Errors 42, 43, 44, 46, 48, 51 and 52 trigger a client self deactivation when the selected provider is DynDNS.org or DynDNS.it or No-IP.org or DynamicDNS.org.

A.6 Internal TCP/UDP/IP stack class error codes

The following table lists all allowed error classes that can be provided by the internal TCP/UDP/IP stack through **+USOER** and **+USOCTL** (with `<param_id>=1`) AT commands.

| Numeric error code | Description | Resulting from the following commands |
|--------------------|--|--|
| 0 | No error | +USOCR, +USOSO, +USOGO, +USOCO, +USOWR, +USOST, +USORD, +USORF, +USOLI |
| 1 | EPERM - Operation not permitted (internal error) | +USOCR, +USOSO, +USOGO, +USOCO, +USOWR, +USOST, +USORD, +USORF, +USOLI |
| 2 | ENOENT - No such resource (internal error) | +USOCR, +USOSO, +USOGO, +USOCO, +USOWR, +USOST, +USORD, +USORF, +USOLI |
| 4 | EINTR - Interrupted system call (internal error) | +USOCR, +USOSO, +USOGO, +USOCO, +USOWR, +USOST, +USORD, +USORF, +USOLI |

| Numeric error code | Description | Resulting from the following commands |
|--------------------|---|--|
| 5 | EIO - I/O error (internal error) | +USOCR, +USOSO, +USOGO, +USOCO, +USOWR, +USOST, +USORD, +USORF, +USOLI |
| 9 | EBADF - Bad file descriptor (internal error) | +USOCR, +USOSO, +USOGO, +USOCO, +USOWR, +USOST, +USORD, +USORF, +USOLI |
| 10 | ECHILD - No child processes (internal error) | +USOCR, +USOSO, +USOGO, +USOCO, +USOWR, +USOST, +USORD, +USORF, +USOLI |
| 11 | EWOULDBLOCK / EAGAIN - Current operation would block, try again | +USOCO, +USOWR |
| 12 | ENOMEM - Out of memory (internal error) | +USOCR, +USOSO, +USOGO, +USOCO, +USOWR, +USOST, +USORD, +USORF, +USOLI |
| 14 | EFAULT - Bad address (internal error) | +USOCR, +USOSO, +USOGO, +USOCO, +USOWR, +USOST, +USORD, +USORF, +USOLI |
| 22 | EINVAL - Invalid argument | +USOCR, +USOSO, +USOGO, +USOCO, +USOWR, +USOST, +USORD, +USORF, +USOLI |
| 32 | EPIPE - Broken pipe (internal error) | +USOCR, +USOSO, +USOGO, +USOCO, +USOWR, +USOST, +USORD, +USORF, +USOLI |
| 38 | ENOSYS - Function not implemented | +USOSO, +USOGO |
| 64 | ENONET - Machine is not on the internet | +USOCR, +USOWR, +USOST, +USORD, +USORF, +USOLI |
| 65 | EEOF - End of file | +USOWR, +USOST, +USORD, +USORF |
| 71 | EPROTO - Protocol error | +USOWR, +USOST, +USORD, +USORF |
| 77 | EBADFD - File descriptor in bad state (internal error) | +USOCR, +USOSO, +USOGO, +USOCO, +USOWR, +USOST, +USORD, +USORF, +USOLI |
| 78 | EREMCHG - Remote address changed | +USOWR, +USOST, +USORD, +USORF, +USOCL |
| 89 | EDESTADDRREQ - Destination address required | +USOCO, +USOST |
| 91 | EPROTOTYPE - Wrong protocol type for socket | +USOCR |
| 92 | ENOPROTOOPT - Protocol not available | +USOCR |
| 93 | EPROTONOSUPPORT - Protocol not supported | +USOCR |
| 94 | ESOCKTNOSUPPORT - Socket type not supported | +USOCR |
| 95 | EOPNOTSUPP - Operation not supported on transport endpoint | +USOWR, +USOST, +USORD, +USORF, +USOCL |
| 96 | EPFNOSUPPORT - Protocol family not supported | +USOCR |
| 97 | EAFNOSUPPORT - Address family not supported by protocol | +USOCR |
| 98 | EADDRINUSE - Address already in use | +USOLI |
| 99 | EADDRNOTAVAIL - Cannot assign requested address | +USOCR, +USOLI, +USOCO |
| 100 | ENETDOWN - Network is down | +USOCR, +USOLI, +USOCO, +USOWR, +USOST, +USORD, +USORF, +USOCL |
| 101 | ENETUNREACH - Network is unreachable | +USOCO, +USOST, +USORF |
| 102 | ENETRESET - Network dropped connection because of reset | +USOCR, +USOLI, +USOCO, +USOWR, +USOST, +USORD, +USORF, +USOCL |
| 103 | ECONNABORTED - Software caused connection abort | +USOCR, +USOSO, +USOGO, +USOCO, +USOWR, +USOST, +USORD, +USORF, +USOLI |
| 104 | ECONNRESET - Connection reset by peer | +USOCR, +USOSO, +USOGO, +USOCO, +USOWR, +USOST, +USORD, +USORF, +USOLI |
| 105 | ENOBUFS - No buffer space available | +USOCR, +USOSO, +USOGO, +USOCO, +USOWR, +USOST, +USORD, +USORF, +USOLI |
| 106 | EISCONN - Transport endpoint is already connected | +USOCO |

| Numeric error code | Description | Resulting from the following commands |
|--------------------|--|--|
| 107 | ENOTCONN - Transport endpoint is not connected | +USOCR, +USOSO, +USOGO, +USOCO, +USOWR, +USOST, +USORD, +USORF, +USOLI |
| 108 | ESHUTDOWN - Cannot send after transport endpoint shutdown | +USOCR, +USOSO, +USOGO, +USOCO, +USOWR, +USOST, +USORD, +USORF, +USOLI |
| 110 | ETIMEDOUT - Connection timed out | +USOCO, +USOST, +USORD, +USORF |
| 111 | ECONNREFUSED - Connection refused | +USOCO |
| 112 | EHOSTDOWN - Host is down | +USOCL, +USOCO, +USOWR, +USOST, +USORD, +USORF |
| 113 | EHOSTUNREACH - No route to host | +USOCO, +USOWR, +USOST, +USORD, +USORF |
| 115 | EINPROGRESS - Operation now in progress | +USOCR, +USOSO, +USOGO, +USOCO, +USOWR, +USOST, +USORD, +USORF, +USOLI |
| 160 | ENSRNODATA - DNS server returned answer with no data | +UDNSRN |
| 161 | ENSRFORMERR - DNS server claims query was misformatted | +UDNSRN |
| 162 | ENSRSERVFAIL - DNS server returned general failure | +UDNSRN |
| 163 | ENSRNOTFOUND - Domain name not found | +UDNSRN |
| 164 | ENSRNOTIMP - DNS server does not implement requested operation | +UDNSRN |
| 165 | ENSRREFUSED - DNS server refused query | +UDNSRN |
| 166 | ENSRBADQUERY - Misformatted DNS query | +UDNSRN |
| 167 | ENSRBADNAME - Misformatted domain name | +UDNSRN |
| 168 | ENSRBADFAMILY - Unsupported address family | +UDNSRN |
| 169 | ENSRBADRESP - Misformatted DNS reply | +UDNSRN |
| 170 | ENSRCONNREFUSED - Could not contact DNS servers | +UDNSRN |
| 171 | ENSRTIMEOUT - Timeout while contacting DNS servers | +UDNSRN |
| 172 | ENSROF - End of file | +UDNSRN |
| 173 | ENSROFILE - Error reading file | +UDNSRN |
| 174 | ENSRNOMEM - Out of memory | +UDNSRN |
| 175 | ENSRDESTRUCTION - Application terminated lookup | +UDNSRN |
| 176 | ENSRQUERYDOMAINTOOLONG - Domain name is too long | +UDNSRN |
| 177 | ENSRNAMELOOP - Domain name is too long | +UDNSRN |

A.7 Internet suite error classes

The following table lists all allowed error classes that can be provided by the <error_class> parameter for these AT error commands:

- SARA-R422M8S / SARA-R422S - +UFTPER, +UHHTPER, +UMQTER, +UMQTTNER, +UCOAPER that provide the error of the last FTP, HTTP, MQTT, MQTT-SN, COAP operation.
- SARA-R404M / SARA-R410M / SARA-R412M / SARA-N4 - +UFTPER, +UHHTPER, +UMQTER that provide the error of the last FTP, HTTP, MQTT operation.

| <error_class> | Description | <error_codes> | Resulting from the following commands |
|---------------|---|--|---------------------------------------|
| 0 | OK, no error occurred | | All |
| 1 | FTP Protocol error class | See the Appendix A.7.1 | +UFTPC, +UFTP |
| 3 | HTTP Protocol error class | See the Appendix A.7.2 | +UHHTP, +UHHTPC |
| 4 | Flash File System error class | See the Appendix A.7.3 | +UFTPC, +UFTPER, +UHHTPC |
| 5 | DNS error class | | +UFTPC, +UHHTPC, +USMTPC |
| 6 | Socket error class | BSD error codes standard | All |
| 7 | Dynamic Memory error | 0 | All |
| 8 | Wrong FTP API usage (e.g. missing/null parameters) | See the Appendix A.7.1 | +UFTPC, +UFTP |
| 10 | Wrong HTTP API usage (e.g. missing/null parameters) | See the Appendix A.7.2 | +UHHTP, +UHHTPC |

| <error_class> | Description | <error_codes> | Resulting from the following commands |
|---------------|--|--|---|
| 11 | Syntax error in high layer Protocol (wrong/missing/corrupted data) | | +UFTPC, +UHTTPC, +USMTPC |
| 12 | Unspecified error | 0 | All |
| 13 | MQTT error class | See the Appendix A.7.4 | +UMQTT, +UMQTTC, +UMQTTWTOPIC, +UMQTTWMSG |
| 14 | MQTT-SN error class | See the Appendix A.7.5 | +UMQTTSN, +UMQTTSNC |
| 15 | CoAP error class | See the Appendix A.7.6 | +UCOAP, +UCOAPC |

A.7.1 FTP class error codes

The following table lists the available values of <error_code> parameter of the last FTP operation provided through +UFTPER AT command if <error_class>=1 or 8 (for more details, see the +UFTP, +UFTPC AT commands description).

| Numeric error code | Description |
|--------------------|--|
| 0 | No error |
| 1 | User missing |
| 2 | Password missing |
| 3 | Account missing |
| 4 | Server missing |
| 5 | Directory name missing |
| 6 | Filename missing |
| 7 | Null parameter |
| 8 | Unknown FTP command |
| 9 | Unknown file action |
| 10 | Wrong FTP state |
| 11 | Wrong parameter |
| 12 | PSD or CSD connection not established |
| 13 | No memory available for allocation |
| 14 | Reserved internal code |
| 15 | Length of given web server (address or hostname) too long or too short |
| 16 | Hostname of given web server invalid |
| 17 | Address of given web server is invalid |
| 18 | Username too long or too short |
| 19 | Password too long or too short |
| 20 | Account too long or too short |
| 21 | Operation not allowed because FTP client is busy |
| 22 | Not possible to connect to FTP server |
| 23 | Error occurred in FTP request |
| 24 | Reserved internal code |
| 25 | FFS filename pointer is null or its length is 0 |
| 26-30 | Reserved internal code |
| 31 | Timeout elapsed while performing requested operation |
| 32 | Internal processing error |
| 33 | Not logged in |
| 34 | Login incorrect |
| 35 | File unavailable (not found or no access) |
| 36 | File not ready |
| 37 | Filename not allowed |
| 38 | Folder not found |
| 39 | Folder no access |
| 40 | Operation aborted by user |
| 41 | Permission denied |
| 42 | Cannot open FTP data channel |
| 43 | Socket invalid parameter |

| Numeric error code | Description |
|--------------------|--|
| 44 | Invalid socket |
| 45 | No socket available |
| 46 | Cannot create socket |
| 47 | Cannot bind socket to network interface |
| 48 | Cannot resolve hostname |
| 49 | Cannot connect socket |
| 50 | Cannot get socket name |
| 51 | Cannot bind socket to port |
| 52 | Socket cannot listen |
| 53 | Socket cannot accept |
| 54 | Socket would block |
| 55 | Socket cannot write |
| 56 | Socket cannot read |
| 57 | Reserved internal code |
| 58 | No socket data to send |
| 59 | Socket cannot get available data |
| 60 | No socket data to read |
| 61 | Socket no response code found |
| 62 | Socket not connected |
| 63 | Cannot set secure socket |
| 64 | Socket cannot decode password |
| 65 | Socket cannot get size |
| 66 | FFS Invalid parameter |
| 67 | FFS invalid handle |
| 68 | FFS cannot open file |
| 69 | FFS cannot seek file |
| 70 | FFS cannot get file size |
| 71 | FFS cannot read |
| 72 | FFS bad offset |
| 73 | FFS cannot write |
| 74 | Direct link internal error |
| 75 | Failed to open extended passive mode |
| 76 | Failed to parse extended passive mode server reply |
| 77 | Internal error |
| 78 | Client IP protocol not supported - try passive mode |
| 79 | Data transfer error. The transferred (received/sent) data is not complete |
| 226 | Closing data connection; requested file action successful (for example, file transfer or file abort) |
| 250 | Requested file action okay, completed |
| 350 | Requested file action pending further information |
| 421 | Service not available, closing control connection. User limit reached Not authorized to make the connection Maximum connections reached Maximum connections exceeded |
| 425 | Cannot open data connection |
| 426 | Connection closed; transfer aborted. The command opens a data connection to perform an action, but that action is cancelled, and the data connection is closed |
| 450 | Requested file action not taken. File unavailable (e.g. file busy) |
| 451 | Requested action aborted: local error in processing |
| 452 | Requested action not taken. Insufficient storage space in system |
| 500 | Syntax error, command unrecognized, command line too long |
| 501 | Syntax error in parameters or arguments |
| 502 | Command not implemented |

| Numeric error code | Description |
|--------------------|---|
| 503 | Bad sequence of commands |
| 504 | Command not implemented for that parameter |
| 530 | User not logged in |
| 532 | Need account for storing files |
| 550 | Requested action not taken. File unavailable, not found, not accessible |
| 552 | Requested file action aborted. Exceeded storage allocation |
| 553 | Requested action not taken. Filename not allowed |

 For all the errors not listed in the table see the RFC 959 [162] and RFC 2428 [163].

A.7.2 HTTP class error codes

The following table lists the available values of <error_code> parameter of the last HTTP operation provided through +UHTTPER AT command if <error_class>=3 or 10 (for more details, see the +UHTTP and +UHTTPC AT commands description).

| Numeric error code | Description |
|--------------------|--|
| 0 | No error |
| 1 | Invalid profile ID |
| 2 | Invalid input |
| 3 | Server hostname too long |
| 4 | Invalid server hostname |
| 5 | Invalid server IP address |
| 6 | Invalid authorization method |
| 7 | Server missing |
| 8 | Username length exceeded |
| 9 | Password length exceeded |
| 10 | Internal error |
| 11 | Server connection error |
| 12 | Error occurred in HTTP request |
| 13 | Internal error |
| 14 | Internal error |
| 15 | Invalid POST data size |
| 16 | Empty FFS filename |
| 17 | Invalid FFS file length |
| 18 | Invalid content-type specified |
| 19 | Internal error |
| 20 | Internal error |
| 21 | Internal error |
| 22 | PSD or CSD connection not established |
| 23 | Server or proxy hostname lookup failed |
| 24 | User authentication failed on server |
| 25 | User authentication failed on proxy |
| 26 | Connection timed out |
| 27 | Request prepare timeout expired |
| 28 | Response receive timeout expired |
| 29 | Request send timeout expired |
| 30 | HTTP operation in progress |
| 31 | Invalid HTTP parameter TCP port not in range (1-65535) |
| 32 | Invalid HTTP parameter secure |
| 33 | Invalid HTTP parameter authentication username |
| 34 | Invalid HTTP parameter authentication password |
| 35 | Invalid HTTP parameter output filename |
| 36 | Invalid HTTP parameter output filename length |
| 37 | Invalid HTTP parameter server path |
| 38 | Invalid HTTP parameter server path length |

| Numeric error code | Description |
|--------------------|--|
| 39 | Invalid HTTP parameter content filename length |
| 40 | Invalid custom content type string |
| 41 | Output file open error |
| 42 | Output file close error |
| 43 | Output file write error |
| 44 | Connection lost |
| 45 | Operation not allowed in current state |
| 46 - 72 | Internal error |
| 73 | Secure socket connect error |

A.7.3 File system class error codes



SARA-R4 / SARA-N4

The following table lists the available values of <error_code> parameter of the last FTP or HTTP operation provided through [+UFTPER](#) and [+UHTTPER](#).

| Numeric error code | Description |
|--------------------|---|
| 2 | Operation performed with success |
| 3 | Initialization in progress |
| 4 | File already opened |
| 5 | File not opened |
| 6 | File not found |
| 7 | File already created |
| 8 | Illegal id |
| 9 | Illegal file handle |
| 10 | Illegal type |
| 11 | Illegal mode |
| 12 | File range error |
| 13 | The operation is not possible |
| 14 | Write error |
| 15 | User id error |
| 16 | Internal fatal error |
| 17 | Memory resource error |
| 18 | Maximum number of files exceeded |
| 19 | Memory not available |
| 20 | Invalid filename |
| 21 | Streaming not enabled |
| 22 | Operation not allowed on static file |
| 23 | Memory table inconsistency |
| 24 | Not a factory default file |
| 25 | Requested memory temporary not available |
| 26 | Operation not allowed for a directory |
| 27 | Space in the directory space not available |
| 28 | Too many streaming files opened |
| 29 | Requested dynamic memory temporary not available |
| 30 | The user provided a NULL parameter instead of a suitable buffer |

A.7.4 MQTT error codes

A.7.4.1 SARA-R410M-02B / SARA-R410M-52B / SARA-R412M / SARA-N4 MQTT error codes

The following table lists the available values of <error_code> parameter of the last MQTT operation provided through [+UMQTT](#) AT command (for more details see, the [+UMQTT](#) and [+UMQTT](#) AT commands description).

| Numeric error code | Description |
|--------------------|---|
| 0 | No error |
| 5 | Error setting initial Default MQTT values |

| Numeric error code | Description |
|--------------------|--|
| 10 | Error creating new MQTT context in response to UMQTT |
| 11 | Error in memory allocation for UMQTT command's response |
| 12 | Error in UMQTT command number of arguments |
| 13 | Error in UMQTT command syntax |
| 14 | UMQTT command parameter Invalid Error |
| 15 | Length (or termination) Error in UMQTT parameter |
| 16 | Range Error in UMQTT command parameter |
| 17 | UMQTT context Invalid Error |
| 18 | UMQTT memory allocation failure Error |
| 19 | UMQTT Profile Restore From or Save To Fail Error |
| 20 | Error creating new MQTT context in response to UMQTTC |
| 21 | Error in memory allocation for UMQTTC command's response |
| 22 | Error in UMQTTC command number of arguments |
| 23 | Error in UMQTTC command syntax |
| 24 | UMQTTC command parameter Invalid Error |
| 25 | Length (or termination) Error in UMQTTC command specifier |
| 26 | Range Error in UMQTTC command specifier |
| 27 | UMQTTC context Invalid Error |
| 28 | No MQTT connection when attempting UMQTTC |
| 29 | Error in UMQTTC's parameter length (or termination) |
| 30 | Error in UMQTTC parameter range |
| 40 | Error in memory allocation for UMQTTER command's response |
| 41 | Error in UMQTTER command syntax |
| 50 | IP Address invalid error |
| 51 | IP Address conversion failed |
| 60 | Input parameter invalid Error |
| 61 | Error in response to get Device |
| 70 | Hex input invalid Error |
| 71 | Hex conversion failed Error |
| 80 | Attempt to display field(s) that exceed(s) the display size (suppressed) |
| 100 | Generic memory allocation failed Error |
| 110 | QAPI FS Statvfs failed Error |
| 111 | QAPI FS Mk Dir failed Error |
| 112 | QAPI FS Open failed Error |
| 113 | QAPI FS File Missing (only sometimes checked for explicitly) |
| 114 | QAPI FS Stat failed Error |
| 115 | QAPI FS Read failed Error |
| 116 | QAPI FS Write failed Error |
| 117 | QAPI FS Close failed Error |
| 118 | QAPI FS Unlink failed Error |
| 120 | QAPI FS Restore file noexist Error |
| 130 | Failed allocation Error during Restore |
| 150 | QMI DMS Init failed Error |
| 151 | QMI DMS De-Init failed Error |
| 160 | QMI DMS send msg fail Error |
| 165 | QMI DMS Dev response fail Error |
| 166 | QMI DMS Dev no IMEI fail Error |
| 167 | QMI DMS Dev IMEI Invalid Error |
| 200 | No Unique Client ID specified Error |
| 201 | No Remote Server specified Error |
| 202 | No Local Client IP Address specified Error |
| 240 | Error encountered when setting MQTT Connect callback |
| 241 | Error encountered when setting MQTT Subscribe callback |
| 242 | Error encountered when setting MQTT Message callback |
| 250 | Error in the MQTT Connect callback's parameters |

| Numeric error code | Description |
|--------------------|--|
| 251 | Error in the MQTT Subscribe callback's parameters |
| 252 | Error in the MQTT Message callback's parameters |
| 350 | Error returned when attempting an MQTT Connection |
| 360 | Publish parameter invalid Error |
| 361 | Error returned when attempting an MQTT Publish |
| 370 | Subscribe parameter invalid Error |
| 371 | Error returned when attempting an MQTT Subscribe |
| 380 | Unsubscribe parameter invalid Error |
| 381 | Error returned when attempting an MQTT Unsubscribe |
| 390 | Error returned when attempting an MQTT Disconnect |
| 400 | Error returned when attempting an MQTT Destroy |
| 410 | Error due to PING Failure |
| 411 | Error response to IPv4 PING attempt |
| 412 | Error response to IPv6 PING attempt |
| 500 | Device Info Init Error |
| 501 | Device Info Release Error |
| 502 | Device Info Get Error |
| 600 | DSS Handle Error |
| 601 | DSS Init Error |
| 602 | DSS Get Device Name Error |
| 603 | DSS allocation Fail Error |
| 604 | DSS Get IP Address Error |
| 700 | DNS Get Server Fail Error |
| 701 | DNS Add Server Fail Error |
| 702 | DNS Client Start Fail Error |
| 703 | DNS Client Stop Fail Error |
| 704 | DNS Name Resolution Fail Error |
| 1000 | Start Data Call Fail Error |

A.7.4.1.1 SARA-R410M-02B / SARA-R410M-52B / SARA-R412M / SARA-N4 MQTT supplemental error codes

The following table lists the available values of <suppl_error_code> parameter of the last MQTT operation provided through **+UMQTT** AT command (for more details, see the **+UMQTT** and **+UMQTT** AT commands description).

| Numeric error code | Description |
|--------------------|---|
| 0 | No error |
| -1 | General error (QAPI) |
| -2 | Invalid parameter (QAPI) |
| -3 | Memory allocation error (QAPI) |
| -4 | Resource allocation error (QAPI) |
| -6 | Operation busy (QAPI) |
| -7 | Entry not found (QAPI) |
| -8 | Feature not supported (QAPI) |
| -9 | Operation timed out (QAPI) |
| -10 | Out of bounds (QAPI) |
| -11 | Bad Payload (QAPI) |
| -12 | Entry already exists (QAPI) |
| -20001 | Error in own certificate (QAPI MQTT) |
| -20002 | Error with SSL connection (QAPI MQTT) |
| -20003 | Handshake must be completed before the operation can be attempted (QAPI MQTT) |
| -20004 | Received SSL warning alert message (QAPI MQTT) |
| -20005 | Received SSL fatal alert message (QAPI MQTT) |
| -20006 | Handshake in progress (QAPI MQTT) |
| -20007 | Handshake successful (QAPI MQTT) |

| Numeric error code | Description |
|--------------------|--|
| -20008 | The SSL certificate of the peer is trusted, CN matches the host name, time is expired (QAPI MQTT) |
| -20009 | The SSL certificate of the peer is trusted, CN does not match the host name, time is valid (QAPI MQTT) |
| -20010 | The SSL certificate of the peer is not trusted (QAPI MQTT) |
| -20011 | Connection drops when out of network buffers (QAPI MQTT) |
| -20012 | Socket error (QAPI MQTT) |
| -20021 | IP address is invalid (QAPI MQTT) |
| -20022 | Failed to get the scope ID (QAPI MQTT) |
| -20023 | Socket command timed out (QAPI MQTT) |
| -20024 | Max server add (v4/v6) reached in server's list (QAPI MQTT) |
| -20025 | MQTT Memory allocation failed (QAPI MQTT) |
| -20026 | MQTT Bad parameter while invoking API (QAPI MQTT) |
| -20027 | MQTT Connection is in bad state (QAPI MQTT) |
| -20028 | MQTT Connection closed (QAPI MQTT) |
| -20029 | MQTT Packet decode failed (QAPI MQTT) |
| -20030 | MQTT Packet encode failed (QAPI MQTT) |
| -20031 | MQTT Negative CONNACK received (QAPI MQTT) |
| -20032 | MQTT no data (QAPI MQTT) |
| -20033 | MQTT no zero ref count while disconnecting (QAPI MQTT) |
| -20034 | MQTT Ping req msg creation failed (QAPI MQTT) |
| -20035 | MQTT Puback msg creation failed (QAPI MQTT) |
| -20036 | MQTT Pubcom msg creation failed (QAPI MQTT) |
| -20037 | MQTT Publish msg creation failed (QAPI MQTT) |
| -20038 | MQTT Pubrec msg creation failed (QAPI MQTT) |
| -20039 | MQTT Pubrel msg creation failed (QAPI MQTT) |
| -20040 | MQTT RX incomplete (QAPI MQTT) |
| -20041 | MQTT Socket fatal error (QAPI MQTT) |
| -20042 | MQTT TCP Bind error (QAPI MQTT) |
| -20043 | MQTT TCP connection error (QAPI MQTT) |
| -20044 | MQTT SSL connection failed (QAPI MQTT) |
| -20045 | MQTT Subscribe msg creation failed (QAPI MQTT) |
| -20046 | MQTT Subscribe unknown topic (QAPI MQTT) |
| -20047 | MQTT Unsubscribe message creation failed (QAPI MQTT) |
| -20048 | MQTT unexpected messaged received (QAPI MQTT) |
| -20049 | MQTT Subscription failed (QAPI MQTT) |
| -20050 | MQTT Restore failed (QAPI MQTT) |
| -150001 | Operation is not permitted (QAPI FS) |
| -150002 | Bad file descriptor (QAPI FS) |
| -150003 | Permission denied (QAPI FS) |
| -150004 | Attempt to cross the device (QAPI FS) |
| -150005 | No such device (QAPI FS) |
| -150006 | Not a directory (QAPI FS) |
| -150007 | Is a directory (QAPI FS) |
| -150008 | Too many open files (QAPI FS) |
| -150009 | File or directory is already open (QAPI FS) |
| -150010 | No space is left on the device (QAPI FS) |
| -150011 | Seek is not permitted (QAPI FS) |
| -150012 | Filename is too long (QAPI FS) |
| -150013 | Directory is not empty (QAPI FS) |
| -150014 | Too many symbolic links were encountered (QAPI FS) |
| -150015 | Illegal byte sequence (QAPI FS) |
| -150016 | Stale remote file handle (QAPI FS) |
| -150017 | Attempt to write beyond the quota (QAPI FS) |
| -150018 | End of file (QAPI FS) |

| Numeric error code | Description |
|--------------------|---|
| -150019 | Invalid ID was passed by the kernel framework (QAPI FS) |
| -150020 | Unknown error (QAPI FS) |

A.7.4.2 SARA-R410M-63B / SARA-R410M-73B / SARA-R410M-83B / SARA-R422M8S / SARA-R422S MQTT class error codes

The following table lists the available values of <error_code> parameter of the last MQTT operation provided through the **+UMQTT** AT command.

| Numeric error code | Description |
|--------------------|--|
| 0 | Operation performed with success |
| 1 | Memory failure |
| 2 | Invalid parameter |
| 3 | Invalid parameter range |
| 4-8 | Internal error |
| 9 | Invalid client identifier |
| 10 | Client identifier length out of range |
| 11 | Syntax error in client identifier |
| 12 | Invalid broker |
| 13 | Broker length out of range |
| 14 | Broker port out of range |
| 15 | Invalid username or password |
| 16 | Username length out of range |
| 17 | Password length out of range |
| 18 | Keep alive time out of range |
| 19 | Security mode out of range |
| 20 | Wrong Security Manager Profile |
| 21 | Security Manager Profile out of range |
| 22 | Invalid topic |
| 23 | Topic length out of range |
| 24 | Missing message or filename |
| 25 | Cannot get file size |
| 26 | File size out of range |
| 27 | Cannot open file |
| 28 | Cannot read file |
| 29 | QOS out of range |
| 30 | Retain out of range |
| 31 | Wrong will message length |
| 32 | Wrong publish message length |
| 33 | Timeout error |
| 34 | No Network service |
| 35 | Broker not connected |
| 36 | Broker connection refused |
| 37 | Broker connection refused, wrong protocol version |
| 38 | Broker connection refused, identifier rejected |
| 39 | Broker connection refused, server unavailable |
| 40 | Broker connection refused, bad user name or password |
| 41 | Broker connection refused, not authorized |
| 42 | MQTT client out of buffer |
| 43 | MQTT client malformed remaining length |
| 44 | MQTT client packet type mismatch |
| 45 | MQTT client packet Id mismatch |
| 46 | MQTT client invalid internal state |
| 47 | MQTT client TLS connect error |
| 48 | MQTT client STDIN Wake error |
| 49 | Incoming message cannot be saved |
| 50 | PSD or CSD connection not established |

| Numeric error code | Description |
|--------------------|-------------------|
| 51 | Error in callback |
| 52 | Malformed packet |

A.7.5 SARA-R422M8S / SARA-R422S MQTT-SN class error codes

The following table lists the available values of <error_code> parameter of the last MQTT-SN operation provided through the [+UMQTTSNER](#) AT command.

A.7.5.1 SARA-R422M8S / SARA-R422S MQTT-SN class error codes

| Numeric error code | Description |
|--------------------|--|
| 0 | Operation performed with success |
| 1 | Memory failure |
| 2 | Invalid parameter |
| 3 | Invalid parameter range |
| 4-8 | Internal error |
| 9 | Invalid client identifier |
| 10 | Client identifier length out of range |
| 11 | Syntax error in client identifier |
| 12 | Invalid gateway |
| 13 | Gateway address length out of range |
| 14 | Gateway port out of range |
| 15 | Invalid topic |
| 16 | Topic length out of range |
| 17 | QOS out of range |
| 18 | Retain out of range |
| 19 | Will message out of range |
| 20 | Publish message out of range |
| 21 | Timeout error |
| 22 | No Network service |
| 23 | Gateway not connected |
| 24 | Not specified error returned by gateway |
| 25 | Congestion |
| 26 | Ivalid topic ID |
| 27 | Not supported |
| 28 | MQTT-SN client: out of buffer |
| 29 | MQTT-SN client: malformed remaining length |
| 30 | MQTT-SN client: packet type mismatch |
| 31 | MQTT-SN client: packet ID mismatch |
| 32 | MQTT-SN client: invalid internal state |
| 33 | MQTT-SN client: STDIN Wake |
| 34 | Incoming message cannot be saved |
| 35 | PSD or CSD connection not established |

A.7.6 CoAP error codes

The following table lists the available values of <error_code> parameter of the last CoAP operation provided through [+UCOAPER](#) (for more details see, the [+UCOAP](#) and [+UCOAPC](#) AT commands description).

| Numeric error code | Description |
|--------------------|----------------------------|
| 0 | No error |
| 1 | Internal error |
| 2 | Invalid input |
| 3 | Invalid 2nd parameter |
| 4 | Invalid 3rd parameter |
| 5 | Parameter count incomplete |
| 6 | Parameter count exceeded |
| 7 | Op code invalid |

| Numeric error code | Description |
|--------------------|--|
| 8 | Server URI missing |
| 9 | Server URI invalid |
| 10 | Server URI length exceeded |
| 11 | Option mask invalid |
| 12 | Option mask value invalid |
| 13 | Profile no invalid |
| 14 | Valid flag incorrect |
| 15 | Profile not found |
| 16 | CoAP operation invalid |
| 17 | Current profile invalid |
| 18 | CoAP URI host option missing |
| 19 | CoAP URI query missing |
| 20 | Payload missing |
| 21 | Payload invalid |
| 22 | Payload length exceeded |
| 23 | Content format invalid |
| 24 | Block count invalid |
| 25 | More block invalid |
| 26 | Payload length incomplete with more block |
| 27 | Module not registered |
| 28 | NW timeout |
| 29 | RAI flag invalid |
| 30 | RAI-1 is not allowed with CON message type |
| 31 | RAI-2 is not allowed with NON message type |
| 32 | CoAP URI path length exceeded |
| 33 | CoAP URI query length exceeded |
| 34 | CoAP URI host length exceeded |

A.8 IP change notification error result codes

The following table lists the available values of <error_code> parameter of the last IP Change Notification provided through +UIPCHGN URC (for more details, see the [+UIPCHGN](#) AT command description).

| Numeric error code | Description |
|--------------------|---|
| 0 | The IP CN feature was enabled from a previous working session and is active |
| 10 | Internal PSD data connection is not active |
| 11 | Invalid IP address assigned to module (e.g. empty string) |
| 12 | IMEI could not be retrieved |
| 13 | IMSI could not be retrieved |
| 14 | Error preparing HTTP GET request for IP CN |
| 15 | Error creating socket for HTTP connection |
| 16 | Error connecting to remote HTTP server |
| 17 | Error sending HTTP GET request to HTTP server |
| 18 | Error receiving or parsing HTTP GET response from HTTP server |

A.9 Ping error result codes

The following table lists the available values of <error_code> parameter of the last ping operation provided through +UUPINGER URC (for more details, see the [+UPING](#) AT command description).

| Numeric error code | Description |
|--------------------|------------------------------|
| 0 | Success (no error) |
| 1-6 | Internal error (ping level) |
| 7 | Empty remote host |
| 8 | Cannot resolve host |
| 9 | Unsupported IP version (RFU) |

| Numeric error code | Description |
|---------------------------|--|
| 10 | Invalid IPv4 address |
| 11 | Invalid IPv6 address (RFU) |
| 12 | Remote host too long |
| 13 | Invalid payload size |
| 14 | Invalid TTL value |
| 15 | Invalid timeout value |
| 16 | Invalid retries number |
| 17 | PSD or CSD connection not established |
| 100 - 105 | Internal error (ICMP level) |
| 106 | Error creating socket for ICMP |
| 107 | Error settings socket options for ICMP |
| 108 | Cannot end ICMP packet |
| 109 | Read for ICMP packet failed |
| 110 | Received unexpected ICMP packet |
| 111-115 | Internal error (socket level) |

B Appendix: AT Commands List

| AT command | Call control | | |
|-----------------------|--------------|---|---|
| | +CVHU | A | D |
| SARA R404M-00B | | • | • |
| R410M-01B | | • | • |
| R410M-02B | | • | • |
| R412M-02B | | • | • |
| R410M-63B / R410M-73B | | • | • |
| R410M-83B | | • | • |
| R410M-52B | | • | • |
| R422-00B | • | | • |
| R422S-00B | • | | • |
| R422M8S-00B | • | | • |
| N410-02B | | | |

| AT command | File System | | | | | |
|-----------------------|-------------|------------|-----------|-----------|-----------|----------|
| | +UDELFILE | +UDWNBLOCK | +UDWNFILE | +ULSTFILE | +URDBLOCK | +URDFILE |
| SARA R404M-00B | • | | | • | | • |
| R410M-01B | • | | | • | | • |
| R410M-02B | • | • | • | • | • | • |
| R412M-02B | • | • | • | • | • | • |
| R410M-63B / R410M-73B | • | • | • | • | • | • |
| R410M-83B | • | • | • | • | • | • |
| R410M-52B | • | • | • | • | • | • |
| R422-00B | • | • | • | • | • | • |
| R422S-00B | • | • | • | • | • | • |
| R422M8S-00B | • | • | • | • | • | • |
| N410-02B | • | • | • | • | • | • |

| AT command | General commands | | | | | | | | | | | | | |
|-----------------------|------------------|-------|-------|-------|-------|-------|-------|-------|------|------|------|------|---------|---|
| | +CCID | +CGMI | +CGMM | +CGMR | +CGSN | +CIMI | +CSCS | +GCAP | +GMI | +GMM | +GMR | +GSN | A/ I | |
| SARA R404M-00B | • | • | • | • | • | • | • | • | • | • | • | • | • | • |
| R410M-01B | • | • | • | • | • | • | • | • | • | • | • | • | • | • |
| R410M-02B | • | • | • | • | • | • | • | • | • | • | • | • | • | • |
| R412M-02B | • | • | • | • | • | • | • | • | • | • | • | • | • | • |
| R410M-63B / R410M-73B | • | • | • | • | • | • | • | • | • | • | • | • | • | • |
| R410M-83B | • | • | • | • | • | • | • | • | • | • | • | • | • | • |
| R410M-52B | • | • | • | • | • | • | • | • | • | • | • | • | • | • |
| R422-00B | • | • | • | • | • | • | • | • | • | • | • | • | • | • |
| R422S-00B | • | • | • | • | • | • | • | • | • | • | • | • | • | • |
| R422M8S-00B | • | • | • | • | • | • | • | • | • | • | • | • | • | • |
| N410-02B | • | • | • | • | • | • | • | • | • | • | • | • | • | • |

| AT command | GPIO interface | | |
|-----------------------|----------------|---------|---------|
| | +UGPIOC | +UGPIOR | +UGPIOW |
| SARA R404M-00B | • | • | • |
| R410M-01B | • | • | • |
| R410M-02B | • | • | • |
| R412M-02B | • | • | • |
| R410M-63B / R410M-73B | • | • | • |
| R410M-83B | • | • | • |
| R410M-52B | • | • | • |
| R422-00B | • | • | • |
| R422S-00B | • | • | • |
| R422M8S-00B | • | • | • |
| N410-02B | • | • | • |

| AT command | I2C interface | | | | |
|-----------------------|---------------|--------|--------|-----------|--------|
| | +UI2CC | +UI2CO | +UI2CR | +UI2CREGR | +UI2CW |
| SARA R404M-00B | | | | | |
| R410M-01B | | | | | |
| R410M-02B | • | • | • | • | • |
| R412M-02B | • | • | • | • | • |
| R410M-63B / R410M-73B | • | • | • | • | • |
| R410M-83B | • | • | • | • | • |
| R410M-52B | • | • | • | • | • |
| R422-00B | • | • | • | • | • |
| R422S-00B | • | • | • | • | • |
| R422M8S-00B | • | • | • | • | • |
| N410-02B | • | • | • | • | • |

| AT command | Internet suite | | | | | | | | | |
|-----------------------|----------------|----------|-------|--------|---------|---------|-----------|----------|-----------|--------|
| | +UDNSRN | +UDYNDNS | +UFTP | +UFTPC | +UFTPER | +UHHTTP | +UHHTTPAC | +UHHTTPC | +UHHTTPER | +UPING |
| SARA R404M-00B | | | | | | | | | | |
| R410M-01B | | | | | | | | | | |
| R410M-02B | • | | | | | | | | | |
| R412M-02B | • | | | | | | | | | |
| R410M-63B / R410M-73B | • | | | | | | | | | |
| R410M-83B | • | | | | | | | | | |
| R410M-52B | • | | | | | | | | | |
| R422-00B | • | • | | | | | | | | • |
| R422S-00B | • | • | | | | | | | | • |
| R422M8S-00B | • | • | | | | | | | | • |
| N410-02B | • | | | | | | | | | |

| AT command | Device and data security | | | | | | | | | | | | | | | |
|-----------------------|--------------------------|-----------|--------------|--------------|--------------|-----------------|-----------------|--------------|--------------|----------|-----------|----------|------------|----------|----------|-------------|
| | +USECCHIP | +USECCONN | +USECDATADEC | +USECDATAENC | +USECDEVINFO | +USECE2EDATAENC | +USECE2EFILEENC | +USECFILEDEC | +USECFILEENC | +USECMNG | +USECMODE | +USECOFF | +USECOPCMD | +USECPRF | +USECPSK | +USECROTUID |
| SARA R404M-00B | | | | | | | | | | | | | | | | |
| R410M-01B | | | | | | | | | | | | | | | | |
| R410M-02B | | | | | | | | | | | | | | | | |
| R412M-02B | | | | | | | | | | | | | | | | |
| R410M-63B / R410M-73B | • | • | • | • | • | • | • | • | • | • | • | • | • | • | • | • |
| R410M-83B | • | • | • | • | • | • | • | • | • | • | • | • | • | • | • | • |
| R410M-52B | | | | | | | | | | | | | | | | |
| R422-00B | • | | | | | | | | | | | | | | | |
| R422S-00B | • | • | • | • | • | • | • | • | • | • | • | • | • | • | • | • |
| R422M8S-00B | • | • | • | • | • | • | • | • | • | • | • | • | • | • | • | • |
| N410-02B | | | | | | | | | | | | | | | | |

| AT command | Localization features | | | | | | | | | | | | | | | | | | |
|-----------------------|-----------------------|--------|--------|--------|--------|--------|--------|-------|--------|--------|--------|--------|--------|--------|-------|---------|-----------|-----------|----------|
| | +UGAOS | +UGGGA | +UGGLL | +UGGSA | +UGGSV | +UGIND | +UGPRF | +UGPS | +UGRMC | +UGSRV | +UGTMR | +UGUBX | +UGVTG | +UGZDA | +ULOC | +UOCAID | +UOCCCELL | +UOCCGNSS | +UOCCIND |
| SARA R404M-00B | | | | | | | | | | | | | | | | | | | |
| R410M-01B | | | | | | | | | | | | | | | | | | | |
| R410M-02B | • | • | • | • | • | • | • | • | • | • | • | • | • | • | • | • | • | • | • |
| R412M-02B | • | • | • | • | • | • | • | • | • | • | • | • | • | • | • | • | • | • | • |
| R410M-63B / R410M-73B | • | • | • | • | • | • | • | • | • | • | • | • | • | • | • | • | • | • | • |
| R410M-83B | • | • | • | • | • | • | • | • | • | • | • | • | • | • | • | • | • | • | • |
| R410M-52B | • | • | • | • | • | • | • | • | • | • | • | • | • | • | • | | | • | • |
| R422-00B | | | | | | | | | | | | | | | | | | | |
| R422S-00B | • | • | • | • | • | • | • | • | • | • | • | • | • | • | • | • | • | • | • |
| R422M8S-00B | • | • | • | • | • | • | • | • | • | • | • | • | • | • | • | • | • | • | • |
| N410-02B | • | • | • | • | • | • | • | • | • | • | • | • | • | • | • | | | • | • |

| AT command | Mobile equipment control and status | | | | | | | | | | |
|-----------------------|-------------------------------------|-------|-------|-------|-------|-------|----------|-------|-------|-------|--------|
| | +CCLK | +CFUN | +CIND | +CMEE | +CMER | +CPAS | +CPWROFF | +CSGT | +CTZR | +CTZU | +UCIND |
| SARA R404M-00B | • | • | • | • | • | • | • | • | • | • | • |
| R410M-01B | • | • | • | • | • | • | • | • | • | • | • |
| R410M-02B | • | • | • | • | • | • | • | • | • | • | • |
| R412M-02B | • | • | • | • | • | • | • | • | • | • | • |
| R410M-63B / R410M-73B | • | • | • | • | • | • | • | • | • | • | • |
| R410M-83B | • | • | • | • | • | • | • | • | • | • | • |
| R410M-52B | • | • | • | • | • | • | • | • | • | • | • |
| R422-00B | • | • | • | • | • | • | • | • | • | • | • |
| R422S-00B | • | • | • | • | • | • | • | • | • | • | • |
| R422M8S-00B | • | • | • | • | • | • | • | • | • | • | • |
| N410-02B | • | • | • | • | • | • | • | • | • | • | • |

| AT command | Network service | | | | | | | | | | | | | | | | | | | | | | | |
|-----------------------|-----------------|-----------|---------|---------|-------|-------|-------|-------|-------|-------|-------|--------|------|--------|------------|-----------|----------|--------|------------|------------|------------|-------|-------------|--|
| | +CCIOTOPT | +CEDRXRDP | +CEDRXS | +CEINFO | +CESQ | +CNUM | +COPN | +COPS | +CPLS | +CPOL | +CREG | +CSCON | +CSQ | +FACSP | +UBANDMASK | +UCFGCIOT | +UCFSCAN | +UCGED | +UDCONF=20 | +UDCONF=77 | +UDCONF=81 | +UJAD | +UMACQOSTMR | |
| SARA R404M-00B | | | | | | | | | | | | | | | | | | | | | | | | |
| R410M-01B | | | | | | | | | | | | | | | | | | | | | | | | |
| R410M-02B | | | | | | | | | | | | | | | | | | | | | | | | |
| R412M-02B | | | | | | | | | | | | | | | | | | | | | | | | |
| R410M-63B / R410M-73B | | | | | | | | | | | | | | | | | | | | | | | | |
| R410M-83B | | | | | | | | | | | | | | | | | | | | | | | | |
| R410M-52B | | | | | | | | | | | | | | | | | | | | | | | | |
| R422-00B | | | | | | | | | | | | | | | | | | | | | | | | |
| R422S-00B | | | | | | | | | | | | | | | | | | | | | | | | |
| R422M8S-00B | | | | | | | | | | | | | | | | | | | | | | | | |
| N410-02B | | | | | | | | | | | | | | | | | | | | | | | | |

| AT command | Network service | | | | | | | |
|-----------------------|-----------------|-------|-----------|-------|-------------|----------|---------|----------|
| | +UMNOPROF | +URAT | +URATSCAN | +URPM | +USVCDOMAIN | +VZWAPNE | +VZWRSP | +VZWRSRQ |
| SARA R404M-00B | | • | | | | | • | • |
| R410M-01B | | • | | | | | • | • |
| R410M-02B | • | • | • | | • | • | • | • |
| R412M-02B | • | • | • | | • | | | |
| R410M-63B / R410M-73B | • | • | | | • | | | |
| R410M-83B | • | • | | | • | | | |
| R410M-52B | • | • | | | • | • | • | • |
| R422-00B | • | • | • | • | • | | | |
| R422S-00B | • | • | • | • | • | | | |
| R422M8S-00B | • | • | • | • | • | | | |
| N410-02B | • | • | | | | • | • | • |

| AT command | | Networking | |
|------------|-----------------------|------------|---|
| SARA | R404M-00B | +UEMBPF | |
| | R410M-01B | | |
| | R410M-02B | | |
| | R412M-02B | | |
| | R410M-63B / R410M-73B | | |
| | R410M-83B | | |
| | R410M-52B | | |
| | R422-00B | | • |
| | R422S-00B | | • |
| | R422M8S-00B | | • |
| | N410-02B | | |

| AT command | Packet switched data services | | | | | | | | | | | | | | | | | |
|-----------------------|-------------------------------|--------|--------|--------|------------|----------|--------|---------|----------|---------|--------|--------|-----------|------------|------------|-------|----|---|
| | +CEMODE | +CEREG | +CGACT | +CGATT | +CGCONTRDP | +CGDCONT | +CGDEL | +CGEREP | +CGPADDR | +CGPIAF | +CGREG | +CIPCA | +UAUTHREQ | +UDCONF=75 | +UDCONF=76 | +UPSD | D* | H |
| SARA R404M-00B | | | | | | | | | | | | | | | | | | |
| R410M-01B | | | | | | | | | | | | | | | | | | |
| R410M-02B | | | | | | | | | | | | | | | | | | |
| R412M-02B | | | | | | | | | | | | | | | | | | |
| R410M-63B / R410M-73B | | | | | | | | | | | | | | | | | | |
| R410M-83B | | | | | | | | | | | | | | | | | | |
| R410M-52B | | | | | | | | | | | | | | | | | | |
| R422-00B | | | | | | | | | | | | | | | | | | |
| R422S-00B | | | | | | | | | | | | | | | | | | |
| R422M8S-00B | | | | | | | | | | | | | | | | | | |
| N410-02B | | | | | | | | | | | | | | | | | | |

| AT command | Device lock | | |
|-----------------------|-------------|-------|-------|
| | +CLK | +CPIN | +CPWD |
| SARA R404M-00B | • | • | • |
| R410M-01B | • | • | • |
| R410M-02B | • | • | • |
| R412M-02B | • | • | • |
| R410M-63B / R410M-73B | • | • | • |
| R410M-83B | • | • | • |
| R410M-52B | • | • | • |
| R422-00B | • | • | • |
| R422S-00B | • | • | • |
| R422M8S-00B | • | • | • |
| N410-02B | • | • | • |

| AT command | Serial interface | | | | | | | | | | | | | | | | | | | | | | | |
|-----------------------|------------------|----|----|----|----|----|--------|------|------|------|---|---|---|-----|-----|----|----|----|----|----|----|----|---|---|
| | &C | &D | &F | &K | &S | &V | +CMLUX | +ICF | +IFC | +IPR | E | O | Q | S10 | S12 | S2 | S3 | S4 | S5 | S6 | S7 | S8 | V | |
| SARA R404M-00B | . | . | . | . | . | . | . | . | . | . | . | . | . | . | . | . | . | . | . | . | . | . | . | . |
| R410M-01B | . | . | . | . | . | . | . | . | . | . | . | . | . | . | . | . | . | . | . | . | . | . | . | . |
| R410M-02B | . | . | . | . | . | . | . | . | . | . | . | . | . | . | . | . | . | . | . | . | . | . | . | . |
| R412M-02B | . | . | . | . | . | . | . | . | . | . | . | . | . | . | . | . | . | . | . | . | . | . | . | . |
| R410M-63B / R410M-73B | . | . | . | . | . | . | . | . | . | . | . | . | . | . | . | . | . | . | . | . | . | . | . | . |
| R410M-83B | . | . | . | . | . | . | . | . | . | . | . | . | . | . | . | . | . | . | . | . | . | . | . | . |
| R410M-52B | . | . | . | . | . | . | . | . | . | . | . | . | . | . | . | . | . | . | . | . | . | . | . | . |
| R422-00B | . | . | . | . | . | . | . | . | . | . | . | . | . | . | . | . | . | . | . | . | . | . | . | . |
| R422S-00B | . | . | . | . | . | . | . | . | . | . | . | . | . | . | . | . | . | . | . | . | . | . | . | . |
| R422M8S-00B | . | . | . | . | . | . | . | . | . | . | . | . | . | . | . | . | . | . | . | . | . | . | . | . |
| N410-02B | . | . | . | . | . | . | . | . | . | . | . | . | . | . | . | . | . | . | . | . | . | . | . | . |

| AT command | Serial interface | | |
|-----------------------|------------------|---|---|
| | X | Z | Q |
| SARA R404M-00B | • | • | • |
| R410M-01B | • | • | • |
| R410M-02B | • | • | • |
| R412M-02B | • | • | • |
| R410M-63B / R410M-73B | • | • | • |
| R410M-83B | • | • | • |
| R410M-52B | • | • | • |
| R422-00B | • | • | • |
| R422S-00B | • | • | • |
| R422M8S-00B | • | • | • |
| N410-02B | • | • | • |

| AT command | | Short Messages Service | | | | | | | | | | | | | | | | | | | | | | |
|------------|-----------------------|------------------------|-------|-------|-------|-------|-------|-------|-------|-------|-------|-------|-------|-------|-------|---------|-------|-------|-------|-------|-------|---------|--------|--------|
| | | +CGSMS | +CMGC | +CMGD | +CMGF | +CMGL | +CMGR | +CMGS | +CMGW | +CMMS | +CMSS | +CNMA | +CNMI | +CPMS | +CRES | +CRTDCP | +CSAS | +CSCA | +CSDH | +CSMP | +CSMS | +CSODCP | +UCMGL | +UCMGP |
| SARA | R404M-00B | | | | | | | | | | | | | | | | | | | | | | | |
| | R410M-01B | | | • | • | • | • | • | • | • | • | • | • | • | • | • | • | • | • | • | • | • | • | • |
| | R410M-02B | | | • | • | • | • | • | • | • | • | • | • | • | • | • | • | • | • | • | • | • | • | • |
| | R412M-02B | | | • | • | • | • | • | • | • | • | • | • | • | • | • | • | • | • | • | • | • | • | • |
| | R410M-63B / R410M-73B | | | • | • | • | • | • | • | • | • | • | • | • | • | • | • | • | • | • | • | • | • | • |
| | R410M-83B | | | • | • | • | • | • | • | • | • | • | • | • | • | • | • | • | • | • | • | • | • | • |
| | R410M-52B | | | • | • | • | • | • | • | • | • | • | • | • | • | • | • | • | • | • | • | • | • | • |
| | R422-00B | • | • | • | • | • | • | • | • | • | • | • | • | • | • | • | • | • | • | • | • | • | • | • |
| | R422S-00B | • | • | • | • | • | • | • | • | • | • | • | • | • | • | • | • | • | • | • | • | • | • | • |
| | R422M8S-00B | • | • | • | • | • | • | • | • | • | • | • | • | • | • | • | • | • | • | • | • | • | • | • |
| | N410-02B | | | • | • | • | • | • | • | • | • | • | • | • | • | • | • | • | • | • | • | • | • | • |

| AT command | | Short Messages Service | | |
|------------|-----------------------|------------------------|--------|--------|
| | | +UCMGR | +UCMGS | +UCMGW |
| SARA | R404M-00B | | | |
| | R410M-01B | | | |
| | R410M-02B | • | • | • |
| | R412M-02B | • | • | • |
| | R410M-63B / R410M-73B | • | • | • |
| | R410M-83B | • | • | • |
| | R410M-52B | • | • | • |
| | R422-00B | • | • | • |
| | R422S-00B | • | • | • |
| | R422M8S-00B | • | • | • |
| | N410-02B | • | • | • |

| AT command | SIM functionalities | | | | | | | | | |
|-----------------------|---------------------|-------|-------|-------|---------|---------|-------|----------|-----------|--------|
| | +CLAN | +CRSM | +CSIM | +CUAD | +CUSATR | +CUSATW | +UBIP | +UCUSATA | +USIMSTAT | +UJICC |
| SARA R404M-00B | | • | | | | | | | | |
| R410M-01B | | • | | | | • | | | | |
| R410M-02B | • | • | • | | • | • | • | • | • | |
| R412M-02B | • | • | • | | • | • | • | • | • | |
| R410M-63B / R410M-73B | • | • | • | | • | • | • | • | • | |
| R410M-83B | • | • | • | | • | • | • | • | • | |
| R410M-52B | • | • | • | | • | • | • | • | • | |
| R422-00B | • | • | • | • | • | • | • | • | • | • |
| R422S-00B | • | • | • | • | • | • | • | • | • | • |
| R422M8S-00B | • | • | • | • | • | • | • | • | • | • |
| N410-02B | • | • | • | | • | • | • | • | • | |

| AT command | System features | | | | | | | | | | | | | | |
|-----------------------|-----------------|------------|------------|-----------|--------|------------|------------|-------------|---------|---------|-----------|-------|--------|---------|------------|
| | +UANTR | +UBKUPDATA | +UDCONF=40 | +UFACTORY | +UFOTA | +UFOTACONF | +UFOTASTAT | +UFWINSTALL | +UFWUPD | +ULGASP | +URINGCFG | +USIO | +UTEMP | +UATEST | +UUARTCONF |
| SARA R404M-00B | • | | | | | | | • | • | | | | | | • |
| R410M-01B | • | | | | | | | • | • | | | | | | • |
| R410M-02B | • | • | | | • | • | • | • | • | • | | | • | • | |
| R412M-02B | • | • | | | • | • | • | • | • | • | | | • | • | |
| R410M-63B / R410M-73B | • | | | | • | • | • | • | • | • | | | • | • | |
| R410M-83B | • | | | | • | • | • | • | • | • | | | • | • | |
| R410M-52B | • | | | | | • | • | • | • | • | | | • | • | |
| R422-00B | • | • | • | • | • | | • | • | • | • | • | • | • | • | • |
| R422S-00B | • | • | • | • | • | | • | • | • | • | • | • | • | • | • |
| R422M8S-00B | • | • | • | • | • | | • | • | • | • | • | • | • | • | • |
| N410-02B | • | | | | | • | • | • | • | • | | | • | • | |

| AT command | Power management | | | | |
|-----------------------|------------------|---------|--------|----------|-------|
| | +CPSMS | +UCPSMS | +UPSMR | +UPSMVER | +UPSV |
| SARA R404M-00B | • | | | | |
| R410M-01B | • | • | | | |
| R410M-02B | • | • | | • | • |
| R412M-02B | • | • | • | • | • |
| R410M-63B / R410M-73B | • | • | • | • | • |
| R410M-83B | • | • | • | • | • |
| R410M-52B | • | • | | • | • |
| R422-00B | • | • | • | • | • |
| R422S-00B | • | • | • | • | • |
| R422M8S-00B | • | • | • | • | • |
| N410-02B | • | • | | | • |

| AT command | Internet protocol transport layer | | | | | | | | | | | | | | | | | | | | | | | |
|-----------------------|-----------------------------------|------------|------------|-----------|-----------|-----------|-----------|-----------|-----------|----------|--------|-----------|--------|--------|---------|--------|--------|--------|--------|--------|--------|---------|--------|---|
| | +UDCONF=1 | +UDCONF=10 | +UDCONF=18 | +UDCONF=2 | +UDCONF=3 | +UDCONF=5 | +UDCONF=6 | +UDCONF=7 | +UDCONF=8 | +UIPCHGN | +USOCL | +USOCLCFG | +USOCO | +USOCR | +USOCTL | +USODL | +USOER | +USOGO | +USOLI | +USORD | +USORF | +USOSEC | +USOSO | |
| SARA R404M-00B | • | • | | • | • | • | • | • | • | | | | • | | • | • | • | • | • | • | • | • | • | • |
| R410M-01B | • | • | | • | • | • | • | • | • | | | | • | | • | • | • | • | • | • | • | • | • | • |
| R410M-02B | • | • | | • | • | • | • | • | • | | | | • | | • | • | • | • | • | • | • | • | • | • |
| R412M-02B | • | • | | • | • | • | • | • | • | | | | • | | • | • | • | • | • | • | • | • | • | • |
| R410M-63B / R410M-73B | • | • | | • | • | • | • | • | • | | | | • | | • | • | • | • | • | • | • | • | • | • |
| R410M-83B | • | • | | • | • | • | • | • | • | | | | • | | • | • | • | • | • | • | • | • | • | • |
| R410M-52B | • | • | | • | • | • | • | • | • | | | | • | | • | • | • | • | • | • | • | • | • | • |
| R422-00B | • | • | • | • | • | • | • | • | • | | | | • | | • | • | • | • | • | • | • | • | • | • |
| R422S-00B | • | • | • | • | • | • | • | • | • | | | | • | | • | • | • | • | • | • | • | • | • | • |
| R422M8S-00B | • | • | • | • | • | • | • | • | • | | | | • | | • | • | • | • | • | • | • | • | • | • |
| N410-02B | • | • | | • | • | • | • | • | • | | | | • | | • | • | • | • | • | • | • | • | • | • |

| AT command | | Internet protocol transport layer | |
|------------|-----------------------|-----------------------------------|--------|
| | | +USOST | +USOWR |
| SARA | R404M-00B | • | • |
| | R410M-01B | • | • |
| | R410M-02B | • | • |
| | R412M-02B | • | • |
| | R410M-63B / R410M-73B | • | • |
| | R410M-83B | • | • |
| | R410M-52B | • | • |
| | R422-00B | • | • |
| | R422S-00B | • | • |
| | R422M8S-00B | • | • |
| | N410-02B | • | • |

| AT command | MQTT | | | | | | | | | |
|-----------------------|--------|----------|-----------|----------|----------|------------|-------------|------------|------------|--------------|
| | +UMQTT | +UMQTTTC | +UMQTTTER | +UMQTTNV | +UMQTTSN | +UMQTTSNVC | +UMQTTSNVER | +UMQTTSNVV | +UMQTTWMSG | +UMQTTWTOPIC |
| SARA R404M-00B | | | | | | | | | | |
| R410M-01B | | | | | | | | | | |
| R410M-02B | • | • | • | • | | | | | • | • |
| R412M-02B | • | • | • | • | | | | | • | • |
| R410M-63B / R410M-73B | • | • | • | • | | | | | • | • |
| R410M-83B | • | • | • | • | | | | | • | • |
| R410M-52B | • | • | • | • | | | | | • | • |
| R422-00B | | | | | | | | | | |
| R422S-00B | • | • | • | • | • | • | • | • | | |
| R422M8S-00B | • | • | • | • | • | • | • | • | | |
| N410-02B | • | • | • | • | | | | | • | • |

| AT command | CoAP | | |
|-----------------------|--------|---------|----------|
| | +UCOAP | +UCOAPC | +UCOAPER |
| SARA R404M-00B | | | |
| R410M-01B | | | |
| R410M-02B | | | |
| R412M-02B | | | |
| R410M-63B / R410M-73B | | | |
| R410M-83B | | | |
| R410M-52B | | | |
| R422-00B | | | |
| R422S-00B | • | • | • |
| R422M8S-00B | • | • | • |
| N410-02B | | | |

| | | Lightweight M2M | | | | | | | | | | | | | | | |
|-----------------------|--|-----------------|-----------|---------|------------|---------------|---------------|---------------|--------------|-------------|---------------|--------------|-------------|------------|---------------|-------------|--------------|
| AT command | | +ODIS | +UHOSTDEV | +ULWM2M | +ULWM2MADD | +ULWM2MCONFIG | +ULWM2MCREATE | +ULWM2MDELETE | +ULWM2MDEREG | +ULWM2MLIST | +ULWM2MNOTIFY | +ULWM2MPULSE | +ULWM2MREAD | +ULWM2MREG | +ULWM2MREMOVE | +ULWM2MSTAT | +ULWM2MWRITE |
| | | SARA R404M-00B | | | | • | | | | | | | | | | | |
| R410M-01B | | | • | • | | | | | | | | | | | | | • |
| R410M-02B | | • | • | • | • | • | • | • | • | • | • | • | • | • | • | • | • |
| R412M-02B | | • | • | • | • | • | • | • | • | • | • | • | • | • | • | • | • |
| R410M-63B / R410M-73B | | | | • | • | • | • | • | • | • | • | • | • | • | • | • | • |
| R410M-83B | | | | • | • | • | • | • | • | • | • | • | • | • | • | • | • |
| R410M-52B | | | • | • | | | | | | | | | | | | | • |
| R422-00B | | | | • | • | • | • | • | • | • | • | • | • | • | • | • | • |
| R422S-00B | | | | • | • | • | • | • | • | • | • | • | • | • | • | • | • |
| R422M8S-00B | | | | • | • | • | • | • | • | • | • | • | • | • | • | • | • |
| N410-02B | | • | • | | | | | | | | | | | | | | • |

B.1 Parameters stored in profiles

The parameter settings of some commands can be stored in the profiles available in the memory module.



Some AT commands have a unique configuration for all the AT interfaces while for other AT commands it is possible to set a different configuration for each AT interface: the "AT interface configuration sharing" column in the next table provides this information.

Some AT command interfaces have a dynamic activation, which means they are not statically activated at boot time (MUX AT channel is activated when the MUX protocol is established, USB AT channel is activated if/when the USB cable is plugged-in, deactivated when it is removed). Since the activation reloads the AT command profile from NVM for the activated interface, the shared "AT interface configurations" could be overwritten. It is suggested to reconfigure them at the requested value if an AT command interface is dynamically activated.

The following table lists the AT commands which setting can be stored in the profiles with their parameters as well as the factory-programmed values.

| AT command | Description | AT interface configuration sharing | Factory-programmed value / Remarks |
|------------|--|------------------------------------|---|
| &C | DCD status | No | 1 (DCD enabled) <ul style="list-style-type: none"> SARA-R4 / SARA-N4 - The command setting is not stored in the personal profile |
| &D | DTR status | No | 1 (DTR enabled) <ul style="list-style-type: none"> SARA-R4 / SARA-N4 - The command setting is not stored in the personal profile |
| &K | Flow control status | No | <ul style="list-style-type: none"> SARA-R4 - The command setting is not stored in the personal profile |
| &S | DSR override | No | 1 (DSR line set to ON in data mode and to OFF in command mode) <ul style="list-style-type: none"> SARA-R4 / SARA-N4 - The command setting is not stored in the personal profile |
| +CGREG | GPRS network registration status reporting | Yes | <ul style="list-style-type: none"> SARA-R4 / SARA-N4 - The command settings is not stored in the personal profile |
| +CMEE | Mobile termination error reporting | Yes | <ul style="list-style-type: none"> SARA-R4 / SARA-N4 - The command settings is not stored in the personal profile |
| +CMGF | Preferred message format | Yes | 0 (format of messages in PDU mode) <ul style="list-style-type: none"> SARA-R4 / SARA-N4 - The command settings is not persistent |
| +CNMI | New message indication | Yes | <ul style="list-style-type: none"> 1 (discard indication and reject new received message URCs when MT-DTE link is reserved) 0 (no SMS-DELIVER indications are routed to the TE) 0 (no CBM indications to the DTE) 0 (no SMS-STATUS-REPORTs are routed to the DTE) 0 (MT buffer of URCs defined within this command is flushed to the DTE when >mode< 1...3 is entered) SARA-R4 / SARA-N4 - The command settings is not stored in the personal profile |
| +COPS | Operator selection | Yes | <ul style="list-style-type: none"> SARA-R4 / SARA-N4 - The command setting is not stored in the personal profile |
| +CPMS | Preferred message storage | No | <ul style="list-style-type: none"> SARA-R4 / SARA-N4 - The command setting is stored in the NVM |
| +CREG | Network registration status reporting | Yes | <ul style="list-style-type: none"> SARA-R4 - The command settings is not stored in the personal profile |
| +CSCA | Service center address | No | <ul style="list-style-type: none"> SARA-R4 / SARA-N4 - The command setting is not stored in the personal profile |
| +CSMP | Select message service | No | <ul style="list-style-type: none"> SARA-R4 / SARA-N4 - The command setting is not stored in the personal profile |
| +CSCS | Select character set configuration | No | <ul style="list-style-type: none"> SARA-R4 / SARA-N4 - The command setting is not stored in the personal profile |
| +CSMS | Select message service | No | <ul style="list-style-type: none"> SARA-R4 / SARA-N4 - The command setting is not stored in the personal profile |

| AT command | Description | AT interface configuration sharing | Factory-programmed value / Remarks |
|------------|--|------------------------------------|--|
| +ICF | DTE-DCE character framing | No | <ul style="list-style-type: none"> SARA-R4 / SARA-N4 - The command setting is not stored in the personal profile |
| +IFC | DTE-DCE local flow control | No | 2 (<DCE_by_DTE> on circuit 106 (CTS)), 2 (<DTE_by_DCE> on circuit 105 (RTS)) |
| +IPR | Baud rate | No | <ul style="list-style-type: none"> SARA-R4 / SARA-N4 - 115200 (115200 b/s) SARA-R4 / SARA-N4 - The command settings is stored in the NVM |
| +UPSV | Power saving control | Yes | <ul style="list-style-type: none"> SARA-R4 / SARA-N4 - The command setting is stored in the NVM |
| +USIO | Serial interfaces configuration | Yes | <ul style="list-style-type: none"> SARA-R4 - The command setting is stored in the NVM |
| E | Echo status | No | 1 (echo enabled) <ul style="list-style-type: none"> SARA-R4 / SARA-N4 - The command setting is stored in the NVM |
| Q | Result code suppression | No | 0 (DCE transmits result codes) <ul style="list-style-type: none"> SARA-R4 / SARA-N4 - The command setting is not stored in the personal profile |
| S2 | Escape character selection | No | 43 (043 corresponds the '+' character) |
| S3 | Command line termination character | No | 13 (0x0d corresponds to the carriage return character) <ul style="list-style-type: none"> SARA-R4 / SARA-N4 - The command setting is not stored in the personal profile |
| S4 | Response formatting character | No | 10 (0x0a corresponds to the line feed character) <ul style="list-style-type: none"> SARA-R4 / SARA-N4 - The command setting is not stored in the personal profile |
| S5 | Command line editing character | No | 8 (008 corresponds to the backspace character) <ul style="list-style-type: none"> SARA-R4 / SARA-N4 - The command setting is not stored in the personal profile |
| S7 | Connection completion timeout | No | 60 |
| V | DCE response format | No | 1 (Verbose response text) <ul style="list-style-type: none"> SARA-R4 / SARA-N4 - The command setting is not stored in the personal profile |
| X | Result code selection and call progress monitoring control | No | 4 (CONNECT <text> result code is given upon entering online data state; dial tone and busy detection are both enabled) <ul style="list-style-type: none"> SARA-R4 / SARA-N4 - The command setting is not stored in the personal profile |



B.2 Parameters stored in non volatile memory

The following table lists the AT commands which setting can be stored in the non volatile memory with their parameters and the factory-programmed values.

| AT command | Description | Factory-programmed value / Comment |
|------------|---------------------------------|---|
| E | Echo status | <ul style="list-style-type: none"> SARA-R4 / SARA-N4 -1 (echo enabled) |
| +CCIOTOPT | CloT optimization configuration | <ul style="list-style-type: none"> SARA-R422 / SARA-R422M8S / SARA-R422S - The +CCIOTOPTI URC configuration (<n>) is not stored in the NVM. For the the UE's support for CloT EPS optimizations and the UE's support for CloT EPS optimizations factory programmed configuration, see Mobile Network Operator profiles. SARA-R410M - The +CCIOTOPTI URC configuration (<n>) is not stored in the NVM. 3 (control plane CloT EPS optimization and user plane CloT EPS optimization supported), 1 (preference for control plane CloT EPS optimization). |
| +CCLK | Clock | <ul style="list-style-type: none"> SARA-R4 / SARA-N4 - "80/01/06,00:00:00+00" |
| +CEDRXS | eDRX setting | 0 (use of eDRX disabled) |

| AT command | Description | Factory-programmed value / Comment |
|------------|--|---|
| +CEMODE | UE modes of operation for EPS | • SARA-R4 / SARA-N4 - 2 (CS/PS mode 2 of operation; "data centric") |
| +CGDCONT | PDP context definition | • SARA-R4 / SARA-N4 - all contexts are undefined |
| +CGSMS | Select service for MO SMS messages | • 1 (CS service selected) |
| +CIPCA | Initial PDP context activation | • SARA-R4 - 0 (do not activate), 0 (EPS attach with PDN connection) |
| +CPMS | Preferred message storage | • SARA-R4 / SARA-N4 - <mem1>, <mem2> and <mem3> are set to "ME" |
| +CPSMS | Power Saving Mode setting | • SARA-R4 / SARA-N4 - 0 (PSM disabled) |
| +CSCA | Service center address setting | • SARA-R4 / SARA-N4 - The command setting is not stored in NVM |
| +CSCON | Connection status signalling | • SARA-R4 / SARA-N4 - 0 (URC disabled) |
| +CSCS | Select character set configuration | • SARA-R4 / SARA-N4 - The command setting is not stored in the NVM |
| +CSGT | Set greeting text | Greeting text is empty |
| +CSMS | Message service configuration | • SARA-R4 / SARA-N4 - The command setting is not stored in NVM |
| +CTZR | Time zone reporting | • SARA-R4 / SARA-N4 - The command setting is not stored in NVM |
| +CTZU | Automatic time zone update | • SARA-R4 / SARA-N4 - 0 (automatic time zone via NITZ disabled) |
| +IPR | Baud rate | • SARA-R4 / SARA-N4 - 115200 (115200 b/s) |
| +UBANDMASK | Band selection bitmask | LTE-M bands bitmask (decimal value): • SARA-R4 - see Mobile Network Operator profiles • SARA-N4 - 275063445663 (bands 1,2,3,4,5,8,12,13,17,18,19,20,25,26,28 and 39) NB-IoT bands bitmask (decimal value): • SARA-R4 - see Mobile Network Operator profiles • SARA-N4 - 185538719 (bands 1,2,3,4,5,8,12,13,17,18,19,20,25,26 and 28) |
| +UBIP | Bearer Independent Protocol status indication | 0 (BIP status indication disabled) • SARA-R410M-02B / SARA-R410M-52B / SARA-R410M-63B / SARA-R410M-73B / SARA-R410M-83B / SARA-R412M / SARA-N4 - The command setting is not stored in the NVM |
| +UCFGCIOT | CIoT capabilities configuration | See Mobile Network Operator profiles |
| +UCOAP | CoAP profile configuration | Empty profile |
| +UCUSATA | Enable USAT terminal URCS | 0 (+CUSATEND, +CUSATP and +UUSIMSTAT URC disabled) |
| +UDCONF=18 | Internal IP stack congestion configuration | 0 (no flow control applied, packets will be dropped in case of congestion at protocol stack) |
| +UDCONF=20 | Steering of Roaming configuration | • SARA-R422 / SARA-R422M8S / SARA-R422S - 1 (SoR is enabled) |
| +UDCONF=40 | User defined power reduction | • SARA-R422 / SARA-R422M8S / SARA-R422S - 3 (MSPR GPRS and EDGE profile), 0 (MSPR GMSK and EDGE profile) |
| +UDCONF=75 | PDP IP configuration when roaming | • SARA-R4 / SARA-N4 - No context is defined |
| +UDCONF=76 | Disable data when roaming | • SARA-R4 / SARA-N4 - No context is defined |
| +UDCONF=77 | NB-IoT band scan tuning | 0 (preference not specified. Platform's default behavior performs all level 0, 1, and 2 scans) |
| +UDCONF=81 | Integrity check on test networks configuration | • SARA-R4 - 1 (integrity check on test networks enabled) |
| +UDYDNS | Dynamic DNS | 0 (Client disabled), 0 (TZO.com as dynamic DNS service provider), "" (Domain name empty), "" (Username empty), "" (Password empty) |
| +UFACTORY | Restore factory configuration | 0 (no FS factory restore), 0 (no NVM factory restore) |
| +UFOTACONF | uFOTA configuration | 1 (module registration to uFOTA server enabled), 604800 (7 days as timer for the periodic connection to the uFOTA server) |

| AT command | Description | Factory-programmed value / Comment |
|-------------------|--|--|
| +UFOTASTAT | FOTA reporting | <ul style="list-style-type: none"> SARA-R410M-63B / SARA-R410M-73B / SARA-R410M-83B - 1 (FOTA downloading state URC enabled) SARA-R410M-02B / SARA-R412M / SARA-R422 / SARA-R422M8S / SARA-R422S - 0 (FOTA downloading state URC disabled) |
| +UGGGA | Get GPS fix data | 0 (NMEA \$GGA messages disabled) |
| +UGLL | Get geographic position | 0 (NMEA \$GLL messages disabled) |
| +UGGSA | Get satellite information | 0 (NMEA \$GSA messages disabled) |
| +UGGSV | Get number of GNSS satellites in view | 0 (NMEA \$GSV messages disabled) |
| +UGIND | Assisted GNSS unsolicited indication | <ul style="list-style-type: none"> SARA-R422M8S / SARA-R422S - The command setting is not stored in the NVM SARA-R410M / SARA-R412M / SARA-N4 - 0 (URC disabled) |
| +UGPIOC | GPIO functionality setting | <ul style="list-style-type: none"> SARA-R4 / SARA-N4 - RI: 255, GPIO1: 255, GPIO2: 255, GPIO3: 255, GPIO4: 255, GPIO5: 255, GPIO6: 255 |
| +UGPRF | GNSS profile configuration | 0 (No data flow on multiplexer, file and IP address), 0 (IP port not defined), "" (Server address string not defined) |
| +UGRMC | Get recommended minimum GNSS data | 0 (NMEA \$RMC messages disabled) |
| +UGSRV | Aiding server configuration | "cell-live1.services.u-blox.com" (primary MGA server), "cell-live2.services.u-blox.com" (secondary MGA server), 14 (Number of days for validation of Offline data), 4 (Number of weeks for validation of Offline data), 1 (Resolution of offline data for MGA), 65 (Desired GNSS for the (offline) aiding: GPS and GLONASS), 0 (AssistNow Online data are downloaded at GNSS receiver power up), 15 (all the desired data types for the (online) aiding are set) |
| +UGVTG | Get course over ground and ground speed | 0 (NMEA \$VTG messages disabled) |
| +UGZDA | Get GPS time and date | 0 (NMEA \$ZDA messages disabled) |
| +UHOSTDEV | LwM2M Host device information | HMAN0 (Host Identification), HMOD0 (Host manufacturer name), HSWO (Host model identification), HUID0 (Host software version) |
| +UIPCHGN | IP change notification | 0 (IP change notification disabled) |
| +UEMBPF | Port filtering for embedded applications | 0 (no port range, filtering disabled) |
| +UJAD | Smart jamming detection | <ul style="list-style-type: none"> SARA-R422 / SARA-R422M8S / SARA-R422S - 0 (smart jamming detection disabled) |
| +ULGASP | Last gasp configuration | <ul style="list-style-type: none"> SARA-R4 / SARA-N4 <ul style="list-style-type: none"> <GPIO_mode>: 0 (disabled) <text>: "" <msg_format>: 0 (text) <profile_id>: 1 <IP_protocol>: 17 (UDP) <IP_addr:PORT>: "" (empty) <method>: 1 (use UDP/IP connection) <urc_enable>: 1 (URC enabled) <nv_upd_freq>: 60 (NVM update frequency in seconds) <tx_count>: 1 (number of times to transmit the Last Gasp message) |
| +ULOCCELL | Configure cellular location sensor (CellLocate®) | 0 (normal mode enabled) |
| +ULOCGNSS | Configure GNSS sensor | <ul style="list-style-type: none"> 15 (Local aiding, AssistNow online, AssistNow offline, AssistNow autonomous enabled), 0 (power saving disabled), 3 (Minimum number of satellites for navigation), 7 (Minimum satellite signal level for navigation), 0 (Disabled initial Fix must be 3D flag), 0 (Static Hold Mode), 0 (SBAS disabled), 0 (Jamming indicator disabled), 0 (Antenna settings unknown), 0 (Broadband jamming detection threshold: 0 dB), 0 (Continuous wave jamming detection threshold: 0 dB), 1 (GPS), 0, 0 |

| AT command | Description | Factory-programmed value / Comment |
|---------------|--|--|
| +ULOCIND | Localization information request status unsolicited indication | <ul style="list-style-type: none"> SARA-R422M8S / SARA-R422S - The command setting is not stored in the NVM SARA-R410M / SARA-R412M / SARA-N4 - 0 (URC disabled) |
| +ULWM2M | LwM2M client activation/deactivation | <ul style="list-style-type: none"> SARA-R404M / SARA-R410M-01B / SARA-R410M-02B / SARA-R410M-52B / SARA-R410M-73B / SARA-R410M-83B / SARA-R412M / SARA-N4 - The command setting is not stored in NVM. SARA-R410M-63B - 3 (communication with NTT DoCoMo servers disabled) SARA-R422 / SARA-R422M8S / SARA-R422S - 0 (LwM2M client enabled) |
| +ULWM2MNOTIFY | LwM2M object notification | <ul style="list-style-type: none"> SARA-R4 - 1 (+ULWM2MNOTIFY URCs enabled) |
| +ULWM2MPULSE | Lightweight M2M pulse configuration | No GPIO pins are configured as LwM2M pulse |
| +ULWM2MSTAT | LwM2M reporting | <ul style="list-style-type: none"> SARA-R410M-02B / SARA-R412M / SARA-R422 / SARA-R422M8S / SARA-R422S - 0 (LwM2M status +ULWM2MSTAT URC disabled) SARA-R410M-63B / SARA-R410M-73B / SARA-R410M-83B - 1 (LwM2M status +ULWM2MSTAT URC enabled) SARA-R404M / SARA-R410M-01B / SARA-R410M-52B / SARA-N4 - 1 (LwM2M FOTA downloading state URC enabled) <p> SARA-R410M-02B / SARA-R412M On SARA-R410M-02B-00, SARA-R410M-02B-01, SARA-R410M-02B-02, SARA-R412M-02B-00, SARA-R412M-02B-01, SARA-R412M-02B-02 the factory-programmed value is 1 (LwM2M FOTA downloading state URC enabled).</p> |
| +UMACQOSTMR | MAC QoS inactivity timer(s) | See Mobile Network Operator profiles |
| +UMNOPROF | MNO profile configuration | <ul style="list-style-type: none"> SARA-R422 / SARA-R422M8S / SARA-R422S - 90 (Global) SARA-R410M-02B / SARA-R410M-52B / SARA-R412M / SARA-N4 - 0 (Undefined) SARA-R410M-63B - 28 (SoftBank) SARA-R410M-73B - 39 (SKT) SARA-R410M-83B - 4 (Telstra) |
| +UPSV | Power saving control | <ul style="list-style-type: none"> SARA-R4 / SARA-N4 - 0 (power saving disabled) |
| +UPSD | Packet switched data | <ul style="list-style-type: none"> SARA-R410M-02B / SARA-R410M-63B / SARA-R410M-73B / SARA-R410M-83B / SARA-R412M / SARA-R422 / SARA-R422M8S / SARA-R422S - for <param_tag>=0 (IP type): 0 (IPv4), for <param_tag>=100 (profile mapped to the specified <cid>): 0 (default bearer PDP ID) SARA-R404M / SARA-R410M-01B / SARA-R410M-52B / SARA-N4 - for <param_tag>=0 (IP type): 0 (IPv4) <p> SARA-R410M-02B / SARA-R412M On SARA-R410M-02B-00, SARA-R410M-02B-01, SARA-R410M-02B-02, SARA-R412M-02B-00, SARA-R412M-02B-01, SARA-R412M-02B-02 the factory-programmed value is for <param_tag>=0 (IP type): 0 (IPv4).</p> |
| +UPSMR | PSM indication | 0 (PSM URC disabled) |
| +UPSMVER | Power Saving Mode configuration | <ul style="list-style-type: none"> SARA-R422 / SARA-R422M8S / SARA-R422S <ul style="list-style-type: none"> <psm_ver>: 4 (PSM deep-sleep enabled) <poi>: 3 (POI in E-UTRAN Cat NB1 and Cat M1 enabled) <oos_scans>: 3 (PLMN scans that need to fail for entering deep-sleep in OOS) <deep_sleep_oos_dur>: 4 (deep-sleep duration in minutes, after the module enters this mode as a consequence of OOS) SARA-R410M / SARA-R412M <ul style="list-style-type: none"> <psm_ver>: 15 (all PSM versions enabled, release 12 PSM with context retention with fallback to PSM without network coordination used) |
| +URAT | Selection of Radio Access Technology | <ul style="list-style-type: none"> SARA-R410M-02B / SARA-R410M-52B / SARA-R410M-83B - 7 (LTE Cat.M1), 8 (NB-IoT) |

| AT command | Description | Factory-programmed value / Comment |
|-------------|--|---|
| | | <ul style="list-style-type: none"> SARA-R412M / SARA-R422 / SARA-R422M8S / SARA-R422S - 7 (LTE Cat.M1), 8 (NB-IoT), 9 (GPRS / eGPRS) SARA-R410M-63B / SARA-R410M-73B - 7 (LTE Cat.M1) SARA-R404M / SARA-R410M-01B - 3 (LTE RAT) SARA-N4 - 8 (NB-IoT) |
| +URATSCAN | CloT configuration - iRAT timer | 60 minutes |
| +URINGCFG | RING line configuration | 0 (RING line handling disabled) |
| +URPM | RPM activation | <ul style="list-style-type: none"> SARA-R422 / SARA-R422M8S / SARA-R422S - see Mobile Network Operator profiles |
| +USECMODE | Secure data suite features configuration | 1 (secure data suite features enabled) |
| +USECOFF | Secure data suite features deactivation | 0 (secure data suite features enabled) |
| +USECOPCMD | Security configuration and action command | <ul style="list-style-type: none"> <apn_name>: "" <pdn_ip_type>: 0 (IPv4) <version>: 1 (E2E encryption V2) |
| +USIMSTAT | (U)SIM initialization status reporting | 0 (URC +UUSIMSTAT disabled) |
| +USIO | Serial interfaces configuration | <ul style="list-style-type: none"> SARA-R4 - 0 (AT command on 9-wire UART, diagnostic log on USB, no AUX UART) |
| +USOCLCFG | Configure Dormant Close Socket Behavior | 1 (TCP socket Graceful Dormant Close feature enabled) |
| +USVCDOMAIN | Configure the device service domain | <ul style="list-style-type: none"> SARA-R410M-02B / SARA-R412M - 2 (CS/PS combined), 0 (IE not present), 1 (data centric) SARA-R422 / SARA-R422M8S / SARA-R422S - see Mobile Network Operator profiles SARA-R410M-52B / SARA-R410M-63B / SARA-R410M-73B / SARA-R410M-83B - 2 (CS/PS combined) <p> SARA-R410M-02B / SARA-R410M-52B On SARA-R410M-02B-01, SARA-R410M-02B-02, SARA-R412M-02B-00, SARA-R410M-02B-01, SARA-R410M-02B-02 the factory programmed value is 2 (CS/PS combined).</p> |
| +UTEST | End user test | Antenna dynamic tuner control: 0 (disabled) |
| +UUARTCONF | UART baud rate and flow control NVM management | 1 (auxiliary UART interface), 115200 (115200 b/s), 3 (RTS/CTS DTE flow control enabled) |
| +VZWAPNE | Edit Verizon wireless APN table | Verizon wireless APN table (APN list entry, APN class, Network identifier, APN type, APN bearer, APN status, APN inactivity timer) <ul style="list-style-type: none"> 1,1,"IMS","ipv4v6","LTE","Enabled",0 2,2,"VZWADMIN","ipv4v6","LTE","Enabled",0 3,3,"VZWINTERNET","ipv4v6","LTE","Enabled",0 4,4,"VZWAPP","ipv4v6","LTE","Enabled",0 6,6,"ENTERPRISE","ipv4v6","LTE","Enabled",0 7,7,"THINGSPACE","ipv4v6","LTE","Enabled",0 Class 1 APN in table above may differ from the one here specified. Refer to +VZWAPNE for details. |

B.3 Saving AT commands configuration



SARA-R4 / SARA-N4

Saving AT commands configuration is not supported.

B.4 Estimated command response time

After having sent a command to a u-blox cellular module, the time to obtain a resulting result code depends on the SIM and the network. It is possible to have an immediate response if the command does not interact with either the network or the SIM.

The following table reports the maximum time to get the result code for the AT commands. The commands are grouped by categories.

| Category | Estimated maximum time to get response | Commands |
|---|---|---|
| Power off | < 40 s | +CPWROFF |
| Set module functionality | Up to 3 min | +CFUN |
| Call control | < 20 s | A, H |
| Dial | Up to 3 min | D |
| Data connection commands | Up to 3 min | +CGATT |
| Network commands | • SARA-R4 / SARA-N4 - Up to 3 min | +COPS, +UCFSCAN |
| Network commands | < 10 s | +URAT, +URATSCAN, +UMACQOSTMR |
| Security | Up to 3 min | +CLCK, +CPWD |
| Delete all SMSes | < 55 s | +CMGD |
| SMS acknowledgement to MT | < 150 s | +CNMA |
| SMS | Up to 3 min (<1 s for prompt ">") | +CPMS, +CMGC, +CMGL, +CMSS, +CMGS, +UCMGS, +UCMGL |
| SIM management | < 10 s | +CMGW, +UCMGW, +CMGR, +UCMGP, +UCMGR, +CNUM, +CPIN, +CPOL, +CRES, +CRSM, +CSCA, +CSMP |
| PDP context activation | < 150 s | +CGACT |
| PDP context deactivation | < 40 s | +CGACT |
| Restore configuration | < 5 s | +UFACTORY |
| End user test (antenna dynamic tuner control) | Up to 1 s | +UTEST |
| GPIO commands | < 10 s | +UGPIOC, +UGPIOR, +UGPIOW |
| Internet suite (socket connect) | • SARA-R4 / SARA-N4 - < 120 s | +USOCO |
| Internet suite (socket connect with SSL) | • SARA-R4 / SARA-N4 - < 1 s | +USOSEC |
| Internet suite (socket write) | • SARA-R4 / SARA-N4 - < 120 s | +USOWR |
| Internet suite (UDP socket write) | • SARA-R4 / SARA-N4 - < 11 s | +USOST |
| Internet suite (socket closure) | • SARA-R4 / SARA-N4 - < 120 s | +USOCL |
| Internet suite | • SARA-R4 / SARA-N4 - < 1 s | +USODL, +USOLI, +USORD, +USORF |
| Resolve name/IP number through DNS | • SARA-R4 / SARA-N4 - < 70 s | +UDNSRN |
| Security suite | < 30 s | +USECMODE, +USECOFF, +USECOPCMD, +USECDEVINFO, +USECDATAENC, +USECFILEENC, +USECDATADEC, +USECFILEDEC, +USECE2EDATAENC, +USECE2EFILEENC, +USECPSK |
| Security suite | < 10 s | +USECONN |
| GNSS commands | < 10 s (except +UGPS for which timeout is according to the performed operation) | +UGAOS, +UGGGA, +UGLL, +UGGSA, +UGGSV, +UGPS, +UGRMC, +UGTMR, +UGUBX, +UGVTG, +UGZDA, +ULOC |
| Last gasp configuration | < 10 s | +ULGASP |
| MQTT command | • SARA-R422M8S / SARA-R422S - immediate | +UMQTTC |
| | • SARA-R4 / SARA-N4 - < 120 s | |
| Firmware update | • SARA-R4 / SARA-N4 - < 20 s | +UFWUPD |

B.5 Multiple AT command interfaces

u-blox cellular modules support multiple AT command interfaces, that means a certain number of virtual or physical channels that work as described in [Definitions](#).

Each interface maintains an own run-time AT commands configuration (AT command profile); this means that the AT command profile is different among the interfaces and therefore the AT commands configuration for the commands belonging to the profile can be different among the interfaces.

At the module start-up, since there is only a set of the profiles (not one for each interface), all the interfaces are configured in the same way (AT commands configuration for the commands in the profile is the same for all the interfaces). Subsequently, each interface can change its run-time AT profile (stored in RAM). The commands **AT&W**, **AT&V** manage this run-time AT commands configuration for the interface where they are issued.

The USB interface implements multiple AT command interfaces. Unlike what happens for the other physical interfaces (e.g. UART, SPI), the AT command interfaces that run on the USB interface only exists as long as the USB interface connects the module with the DTE. As a result, if the USB connection between the module and the DTE is interrupted (e.g. by USB cable removal), all the AT command interfaces running on it are destroyed. This has two main consequences:

- Any data connection (both circuit switched and packet switched) established over an AT command interface associated to the USB interface is released.
- Whenever the USB connection between the module and the DTE is re-established, the AT command interfaces running on it are created, and for each of these interfaces the AT command profile is reloaded from NVM and applied.



The reload of the AT command profile from the NVM also results in the re-application of the **+UPSV** setting, which is a shared "AT interface configuration". This must be kept in mind, since the change could have impacts on the communication over the UART interface.

As mentioned in [Definitions](#), generally there is not difference in the execution of an AT command among the interfaces. But, there are some exceptions due to interface restrictions. In particular, the differences relate to AT commands that configure the DCE-DTE interface.

[Table 32](#) provides the major differences.

| AT command | UART / AUX UART (where available) | Multiplexer | USB (where available) | SPI (where available) |
|---------------|-----------------------------------|---|--|--|
| &K | Effective | When it returns OK (the configuration is allowed), it is effective | When it returns OK (the configuration is allowed), it is not effective (only change the value in the AT command profile) | When it returns OK (the configuration is allowed), it is not effective (only change the value in the AT command profile) |
| \Q | Effective | When it returns OK (the configuration is allowed), it is effective | When it returns OK (the configuration is allowed), it is not effective (only change the value in the AT command profile) | When it returns OK (the configuration is allowed), it is not effective (only change the value in the AT command profile) |
| +ICF | Effective | Returns OK, but it is not effective (only change the value in the AT command profile) | Returns OK, but it is not effective (only change the value in the AT command profile) | Returns OK, but it is not effective (only change the value in the AT command profile) |
| +IFC | Effective | When it returns OK (the configuration is allowed), it is effective | When it returns OK (the configuration is allowed), it is not effective (only change the value in the AT command profile) | When it returns OK (the configuration is allowed), it is not effective (only change the value in the AT command profile) |
| +IPR | Effective | Returns OK, but it is not effective (only change the value in the AT command profile) | Returns OK, but it is not effective (only change the value in the AT command profile) | Returns OK, but it is not effective (only change the value in the AT command profile) |
| +UPSV | Effective | Returns OK, but it changes UART setting | Returns OK, but it changes UART setting | Returns OK, but it changes UART setting |

Table 32: Interface comparison



SARA-R4 / SARA-N4

It is not possible to have parallel activity on two or more AT terminals. Basically this behavior can be detected in the following configurations:

- Double UART availability, i.e. **+USIO: 1** (where supported).

- Virtual channels set through the multiplexer (MUX) protocol.

The only allowed parallel activity is present when it is defined a system architecture with a PPP dial-up on one port and AT commands on the other one.

C Mobile Network Operator profiles

C.1 SARA-R4 Introduction

By means of `+UMNOPROF` AT command the module is able to manage different MNO profiles that configure the module according to the MNO requirements. Reboot the module by means of the `+CFUN` AT command to make the MNO profile active. For more details, see `+UMNOPROF` AT command.

Depending on the module type numbers the MNO profile version can assume different settings. The following tables provide an overview of each MNO profile and the list of AT commands whose setting can be overridden by the MNO profile. Depending on MNO profile the corresponding AT command setting can be locked by the MNO profile (see "Locked" field for more details).



The `<MNO>=101` (standard Europe No-ePCO) profile factory-programmed configuration is the same of the `<MNO>=100` (standard Europe profile), but the ePCO is disabled.

C.2 SARA-R422 / SARA-R422M8S / SARA-R422S Americas MNO and conformance profiles table

| GCF-PTCRB | |
|---------------------------------|--|
| MNO profile | |
| <MNO> | 201 |
| +UBANDMASK | |
| LTE-M bands [decimal value] | 1, 2, 3, 4, 5, 8, 12, 13, 20, 25, 26, 28, 66 [185079967, 2] |
| NB-IoT bands [decimal value] | 1, 2, 3, 4, 5, 8, 12, 13, 20, 28, 66, 85 [134748319, 10 48578] |
| GSM bands [decimal value] | 850, 900, 1800, 1900 [2621824] |
| Locked | No |
| +URAT | |
| Allowed values | LTE Cat M1, NB-IoT, GPRS/ eGPRS |
| Locked | No |
| +CGDCONT | |
| Data profile 1 | IPV4V6, "" |
| Data profile 2 | empty |
| Data profile 3 | empty |
| Data profile 4 | empty |
| Data profile 6 | empty |
| +USVCDOMAIN | |
| Service domain | CS/PS |
| LwM2M feature | |
| Available | No |
| LwM2M capabilities | n/a |
| uFOTA-LwM2M capabilities | n/a |
| +URPM | |
| Enabled | False |
| +CCIOTOPT | |
| UE supported | Control and user plane |
| UE preferred | Control plane |
| +UCFGCIOT | |
| S1-U | Enabled |
| HC-CPCIOT | Enabled |
| SMS only | Enabled |
| ePCO | Enabled |
| CE restriction | Enabled |
| CP data backoff timer | Enabled |
| Locked | No |
| +UMACQOSTMR | |

| GCF-PTCRB | |
|------------------|----------|
| LTE Cat M1 timer | Disabled |
| NB-IoT timer | Disabled |
| Locked | No |

**SARA-R4**

The **+CEDRXS** and **+CPSMS** AT commands setting are not dependant on the selected MNO profile.

C.3 SARA-R422 / SARA-R422M8S / SARA-R422S EMEA MNO profiles table

| | Deutsche Telekom | Standard Europe | Vodafone | Orange France | Global |
|---------------------------------|---------------------------------------|---------------------------------------|---------------------------------------|---------------------------|--|
| MNO profile | | | | | |
| <MNO> | 31 | 100 | 19 | 46 | 90 |
| +UBANDMASK | | | | | |
| LTE-M bands [decimal value] | 3, 8, 20 [524420] | 3, 8, 20 [524420] | 3, 8, 20 [524420] | 3, 8, 20 [524420] | 1, 2, 3, 4, 5, 8, 12, 13, 20, 25, 26, 28, 66 [185079967, 2] |
| NB-IoT bands [decimal value] | 3, 8, 20 [524420] | 3, 8, 20 [524420] | 3, 8, 20 [524420] | n/a | 1, 2, 3, 4, 5, 8, 12, 13, 20, 28, 66, 85 [134748319, 10 48578] |
| GSM bands [decimal value] | 900, 1800 [384] | 900, 1800 [384] | 900, 1800 [384] | 900, 1800 [384] | 850, 900, 1800, 1900 [2621824] |
| Locked | No | No | No | No | No |
| +URAT | | | | | |
| Allowed values | LTE Cat M1, NB-IoT, GPRS/ eGPRS | LTE Cat M1, NB-IoT, GPRS/ eGPRS | LTE Cat M1, NB-IoT, GPRS/ eGPRS | LTE Cat M1, GPRS/eGPRS | LTE Cat M1, NB-IoT, GPRS/ eGPRS |
| Locked | No | No | No | No | No |
| +CGDCONT | | | | | |
| Data profile 1 | IPV4V6, "" | IPV4V6, "" | IPV4V6, "" | IPV4V6, "" | IPV4V6, "" |
| Data profile 2 | empty | empty | empty | empty | empty |
| Data profile 3 | empty | empty | empty | empty | empty |
| Data profile 4 | empty | empty | empty | empty | empty |
| Data profile 6 | empty | empty | empty | empty | empty |
| LwM2M feature | | | | | |
| Available | Yes | Yes | Yes | Yes | Yes |
| LwM2M capabilities | u-blox | u-blox | u-blox | u-blox | u-blox |
| uFOTA-LwM2M capabilities | uFOTA | uFOTA | uFOTA | uFOTA | uFOTA |
| +USVCDOMAIN | | | | | |
| Service domain | CS/PS | CS/PS | CS/PS | CS/PS | CS/PS |
| +URPM | | | | | |
| Enabled | True | False | False | False | False |
| +CCIOPT | | | | | |
| UE supported | Control plane | Control plane | Control plane | Control plane | Control plane |
| UE preferred | Control plane | Control plane | No preference | Control plane | Control plane |
| +UCFGCIOT | | | | | |
| S1-U | Enabled | Enabled | Disabled | Enabled | Enabled |
| HC-CPCIOT | Disabled | Enabled | Disabled | Enabled | Enabled |
| SMS only | Disabled | Enabled | Disabled | Enabled | Enabled |
| ePCO | Enabled | Enabled | Enabled | Enabled | Enabled |
| CE restriction | Disabled | Disabled | Disabled | Disabled | Disabled |
| CP data backoff timer | Disabled | Disabled | Disabled | Disabled | Disabled |
| Locked | No | No | No | No | No |
| +UMACQOSTMR | | | | | |

| | Deutsche Telekom | Standard Europe | Vodafone | Orange France | Global |
|------------------|-------------------------|------------------------|-----------------|----------------------|---------------|
| LTE Cat M1 timer | 90 s | 90 s | 90 s | 90 s | 90 s |
| NB-IoT timer | 120 s | 120 s | 120 s | 120 s | 120 s |
| Locked | No | No | No | No | No |



SARA-R4

The **+CEDRXS** and **+CPSMS** AT commands setting are not dependant on the selected MNO profile.

C.4 SARA-R410M-02B Americas MNO profile tables

| | Undefined | AT&T | Verizon | T-Mobile US | Sprint | Telus |
|---------------------------------|--|--------------------------|-------------------------------|-----------------------|----------------------|-----------------------|
| MNO profile | | | | | | |
| <MNO> | 0 | 2 | 3 | 5 ¹⁰ | 8 ¹¹ | 21 ¹² |
| Version | n/a | 8.1 ¹³ | 8.3 ¹⁴ | 7.0 ¹⁵ | 8.0 ¹⁶ | 8.0 ¹⁷ |
| +UBANDMASK | | | | | | |
| LTE-M bands [decimal value] | 2, 3, 4, 5, 8, 12, 13, 18, 19, 20, 25 [17701022] ¹⁸ | 2, 4, 5, 12 [2074] | 4, 13 [4104] ¹⁹ | n/a | 12, 25 [16779264] | 2, 4, 5, 12 [2074] |
| NB-IoT bands [decimal value] | 2, 3, 4, 5, 8, 12, 13, 18, 19, 20 [923806] ²⁰ | n/a | n/a | 2, 4, 5, 12 [2074] | n/a | n/a |
| Locked | Yes ²¹ | Yes ²¹ | Yes ²¹ | No | No | No |
| +URAT | | | | | | |
| Allowed values | LTE Cat M1, NB- IoT | LTE Cat M1 | LTE Cat M1 | NB-IoT | LTE Cat M1 | LTE Cat M1 |
| Locked | Yes ²² | Yes ²² | Yes ²² | No | No | No |
| +CPSMS | | | | | | |
| Enabled | False | False ²³ | False | False | False | True |
| T3324 | 6 s | 6 s | 6 s | 6 s | 6 s | 6 s |
| T3412_ext | 150 s | 150 s | 150 s | 150 s | 150 s | 3240 s |
| Locked | No | No | No | No | No | No |
| +CEDRXS | | | | | | |
| Enabled | False ²⁴ | False ²⁴ | False | False | False | True |
| Paging time window | 7 | 7 | 7 | 7 | 7 | 7 |
| eDRX cycle length | 9 | 9 | 9 | 9 | 9 | 9 |
| Locked | No | No | No | No | No | No |
| +CGDCONT | | | | | | |
| Data profile 1 | empty ²⁵ | IPV4V6, "" ²⁶ | IPV4V6, "" | empty ²⁷ | empty | empty |

¹⁰ <MNO>=5 (T-Mobile US) is not supported by SARA-R410M-02B-02, SARA-R410M-02B-03.

¹¹ <MNO>=8 (Sprint) is not supported by SARA-R410M-02B-00, SARA-R410M-02B-02.

¹² <MNO>=21 (Telus) is not supported by SARA-R410M-02B-00.

¹³ On SARA-R410M-02B-02 the <MNO>=2 (AT&T) profile version is 7.2. On SARA-R410M-02B-01 the <MNO>=2 (AT&T) profile version is 7.1. On SARA-R410M-02B-00 the <MNO>=2 (AT&T) profile version is 2.0.

¹⁴ On SARA-R410M-02B-02 the <MNO>=3 (Verizon) profile version is 7.1. On SARA-R410M-02B-01 the <MNO>=3 (Verizon) profile version is 7.0. On SARA-R410M-02B-00 the <MNO>=3 (Verizon) profile version is 2.0.

¹⁵ On SARA-R410M-02B-00 the <MNO>=5 (T-Mobile US) profile version is 2.0.

¹⁶ On SARA-R410M-02B-01 the <MNO>=8 (Sprint) profile version is 7.0.

¹⁷ On SARA-R410M-02B-01, SARA-R410M-02B-02 the <MNO>=21 (Telus) profile version is 7.0.

¹⁹ On SARA-R410M-02B-00, SARA-R410M-02B-01, SARA-R410M-02B-02 the LTE-M band enabled by factory-programmed configuration is: 13 [4096].

¹⁸ On SARA-R410M-02B-01 the LTE-M bands enabled by factory-programmed configuration are: 1, 2, 3, 4, 5, 8, 12, 13, 18, 19, 20, 25, 26, 28 [185473183]. On SARA-R410M-02B-00 the LTE-M bands enabled by factory-programmed configuration are: 1, 2, 3, 4, 5, 8, 12, 13, 17, 18, 19, 20, 25, 26, 28, 39 [275063445663].

²⁰ On SARA-R410M-02B-01 the NB-IoT bands enabled by factory-programmed configuration are: 1, 2, 3, 4, 5, 8, 12, 13, 18, 19, 20, 25, 26, 28 [185473183]. On SARA-R410M-02B-00 the NB-IoT bands enabled by factory-programmed configuration are: 1, 2, 3, 4, 5, 8, 12, 13, 17, 18, 19, 20, 25, 26, 28 [185538719].

²¹ On SARA-R410M-02B-00 the +UBANDMASK AT command setting is not locked.

²² On SARA-R410M-02B-00 the +URAT AT command setting is not locked.

²³ On SARA-R410M-02B-01 by factory-programmed configuration the PSM is enabled (see +CPSMS).

²⁴ On SARA-R410M-02B-00 by factory-programmed configuration the use of eDRX is enabled (see +CEDRXS).

²⁵ On SARA-R410M-02B-00 by factory-programmed configuration the data profile 1 is set to: IPV4V6, "".

| | Undefined | AT&T | Verizon | T-Mobile US | Sprint | Telus |
|-----------------------------------|------------------|------------------|--------------------------------------|---------------------------------------|-------------------|----------|
| Data profile 2 | empty | empty | IPV4V6, "vzwadmin" | IPv6,"iot.nb" ²⁸ | empty | empty |
| Data profile 3 | empty | empty | IPV4V6, "vzwinternet" | NONIP, "iot.nb.nidd" ²⁹ | empty | empty |
| Data profile 4 | empty | empty | IPV4V6, "vzwapp" ³⁰ | empty | empty | empty |
| Data profile 6 | empty | empty | IPV4V6, "VZWCLASS6" ³¹ | empty | empty | empty |
| LwM2M feature³² | | | | | | |
| Available | No | Yes | Yes | n/a | Yes | Yes |
| LwM2M capabilities | n/a | u-blox, AT&T | u-blox, VZW | n/a | u-blox | u-blox |
| uFOTA-LwM2M capabilities | n/a | uFOTA | uFOTA, VZW | n/a | uFOTA | uFOTA |
| +ULWM2MREG | | | | | | |
| Supported server ID ³³ | 0 | 0, 3, 721 | 0, 101, 102, 721, 1000 | n/a | 721 | 721 |
| Locked ³³ | No | No | No | n/a | No | No |
| +USVCDOMAIN | | | | | | |
| Service domain | CS+PS | CS+PS | CS+PS | PS ³⁴ | CS+PS | CS+PS |
| +UMACQOSTMR | | | | | | |
| LTE Cat M1 timer ³⁵ | 35 s | 35 s | 35 s | n/a | 35 s | 35 s |
| NB-IoT timer ³⁵ | Disabled | Disabled | Disabled | n/a | Disabled | Disabled |
| Locked ³⁵ | No | No | No | n/a | No | No |
| MNO profile | | | | | | |
| <MNO> | 33 ³⁶ | 43 ³⁷ | 44 ³⁸ | 45 ³⁹ | 206 ⁴⁰ | |
| Version | 8.1 | 8.0 | 8.1 | 8.0 | 8.2 | |
| +UBANDMASK | | | | | | |
| LTE-M bands | 3, 28 | 2, 4, 5, 12 | 3, 28 | n/a | 2, 4, 12 | |

²⁶ On SARA-R410M-02B-00 and SARA-R410M-02B-01 by factory-programmed configuration the data profile 1 is set to: IPV4V6,"phone".

²⁷ On SARA-R410M-02B-00 by factory-programmed configuration the data profile 1 is set to: IPV4V6,"".

²⁸ On SARA-R410M-02B-00 by factory-programmed configuration the data profile 2 is an empty profile.

²⁹ On SARA-R410M-02B-00 by factory-programmed configuration the data profile 3 is an empty profile.

³⁰ On SARA-R410M-02B-00 by factory-programmed configuration the data profile 4 is set to: IPV4V6, "VZWCLASS6".

³¹ On SARA-R410M-02B-00, SARA-R410M-02B-01, SARA-R410M-02B-02 by factory-programmed configuration the data profile 6 is an empty profile.

³² The LwM2M feature is not supported by SARA-R410M-02B-00, SARA-R410M-02B-01, SARA-R410M-02B-02.

³³ The **+ULWM2MREG** AT command is not supported by SARA-R410M-02B-00, SARA-R410M-02B-01, SARA-R410M-02B-02.

³⁴ On SARA-R410M-02B-00 by factory-programmed configuration the service domain is CS+PS.

³⁵ The **+UMACQOSTMR** AT command is not supported by SARA-R410M-02B-00, SARA-R410M-02B-01, SARA-R410M-02B-02.

³⁶ <MNO>=33 (VIVO) is not supported by SARA-R410M-02B-00, SARA-R410M-02B-01, SARA-R410M-02B-02.

³⁷ <MNO>=43 (Rogers) is not supported by SARA-R410M-02B-00, SARA-R410M-02B-01, SARA-R410M-02B-02.

³⁸ <MNO>=44 (Claro Brasil) is not supported by SARA-R410M-02B-00, SARA-R410M-02B-01, SARA-R410M-02B-02.

³⁹ <MNO>=45 (TIM Brasil) is not supported by SARA-R410M-02B-00, SARA-R410M-02B-01, SARA-R410M-02B-02.

⁴⁰ <MNO>=206 (FirstNet) is not supported by SARA-R410M-02B-00, SARA-R410M-02B-01, SARA-R410M-02B-02.

| | VIVO | Rogers | Claro Brasil | TIM Brasil | FirstNet |
|--------------------------------|----------------------------------|-------------|----------------------------------|-------------------------------|--------------------------------|
| [decimal value] | [134217732] | [2074] | [134217732] | | [2058] |
| NB-IoT bands | 28 | 2, 4, 5, 12 | 3, 5, 28 | 3, 28 | n/a |
| [decimal value] | [134217728] | [2074] | [134217748] | [134217732] | |
| Locked | No | No | No | No | Yes |
| +URAT | | | | | |
| Allowed values | NB-IoT | LTE Cat M1 | LTE Cat M1, NB-IoT | NB-IoT | LTE Cat M1 |
| Locked | No | Yes | No | No | Yes |
| +CPSMS | | | | | |
| Enabled | True | True | True | True | False |
| T3324 | 180 s | 6 s | 180 s | 6 s | 6 s |
| T3412_ext | 14400 s | 3240 s | 5760 s | 150 s | 150 s |
| Locked | No | No | No | No | No |
| +CEDRXS | | | | | |
| Enabled | True | True | True | True | False |
| Paging time window | 7 | 7 | 5 | 7 | 7 |
| eDRX cycle length | 9 | 9 | 163 | 9 | 9 |
| Locked | No | No | No | No | No |
| +CGDCONT | | | | | |
| Data profile 1 | IPV4V6, "kiteiot.vivo.com.br" | empty | IPV4V6, "cat-m1.claro.com.br" | IPV4V6, "nbiot" | empty |
| Data profile 2 | empty | empty | IPV4V6, "nbiot.claro.com.br" | IPV4V6, "timbrasil.com.br" | IPV4V6, "attiotfirstnet.fn" |
| Data profile 3 | empty | empty | IPV4V6, "iot.claro.com.br" | empty | empty |
| Data profile 4 | empty | empty | empty | empty | empty |
| Data profile 6 | empty | empty | empty | empty | empty |
| LwM2M feature | | | | | |
| Available | Yes | Yes | Yes | Yes | Yes |
| LwM2M capabilities | u-blox | u-blox | u-blox | u-blox | u-blox, AT&T |
| uFOTA-LwM2M capabilities | uFOTA | uFOTA | uFOTA | uFOTA | uFOTA |
| +ULWM2MREG | | | | | |
| Supported server ID | 721 | 721 | 721 | 721 | 0, 3, 721 |
| Locked | No | No | No | No | No |
| +USVCDOMAIN | | | | | |
| Service domain | CS+PS | CS+PS | CS+PS | CS+PS | CS+PS |
| +UMACQOSTMR | | | | | |
| LTE Cat M1 timer ⁴¹ | 35 s | 35 s | 35 s | 35 s | 35 s |
| NB-IoT timer ⁴¹ | Disabled | Disabled | Disabled | Disabled | Disabled |
| Locked ⁴¹ | No | No | No | No | No |

⁴¹ The **+UMACQOSTMR** AT command is not supported by SARA-R410M-02B-00, SARA-R410M-02B-01, SARA-R410M-02B-02.

C.5 SARA-R410M-02B APAC MNO profiles table

| | Telstra | China Telecom |
|------------------------------------|-------------------------------|---------------------|
| MNO profile | | |
| <MNO> | 4 ⁴² | 6 ⁴³ |
| Version | 8.0 ⁴⁴ | 7.0 ⁴⁵ |
| +UBANDMASK | | |
| LTE-M bands [decimal value] | 3, 5, 8, 28 [134217876] | 3, 5, 8 [148] |
| NB-IoT bands [decimal value] | n/a | 3, 5, 8 [148] |
| Locked | Yes ⁴⁶ | No |
| +URAT | | |
| Allowed values | LTE Cat M1 | LTE Cat M1, NB-IoT |
| Locked | Yes ⁴⁷ | No |
| +CPSMS | | |
| Enabled | False ⁴⁸ | False |
| T3324 | 60 s | 6 s |
| T3412_ext | 86400 s | 3240 s |
| Locked | No | No |
| +CEDRXS | | |
| Enabled | False | True |
| Paging time window | 7 | 3 |
| eDRX cycle length | 2 | 9 |
| Locked | No | No |
| +CGDCONT | | |
| Data profile 1 | IPV4V6, "telstra.internet" | empty ⁴⁹ |
| Data profile 2 | empty | empty |
| Data profile 3 | empty | empty |
| Data profile 4 | empty | empty |
| Data profile 6 | empty | empty |
| LwM2M feature ⁵⁰ | | |
| Available | Yes | n/a |
| LwM2M capabilities | u-blox | n/a |
| uFOTA-LwM2M capabilities | uFOTA | n/a |
| +ULWM2MREG | | |
| Supported server ID ⁵¹ | 721 | n/a |
| Locked ⁵¹ | No | n/a |

⁴² <MNO>=4 (Telstra) is not supported by SARA-R410M-02B-02.

⁴³ <MNO>=6 (China Telecom) is not supported by SARA-R410M-02B-02, SARA-R410M-02B-03.

⁴⁴ On SARA-R410M-02B-01 the <MNO>=4 (Telstra) profile version is 7.0. On SARA-R410M-02B-00 the <MNO>=4 (Telstra) profile version is 2.0.

⁴⁵ On SARA-R410M-02B-00 the <MNO>=6 (China Telecom) profile version is 2.0.

⁴⁶ On SARA-R410M-02B-00 the **+UBANDMASK** AT command setting is not locked.

⁴⁷ On SARA-R410M-02B-00 the **+URAT** AT command setting is not locked.

⁴⁸ On SARA-R410M-02B-00 by factory-programmed configuration the PSM is enabled (see **+CPSMS**).

⁴⁹ On SARA-R410M-02B-00 by factory-programmed configuration the data profile 1 is set to: IPV4V6, " ".

⁵⁰ The LwM2M feature is not supported by SARA-R410M-02B-00, SARA-R410M-02B-01, SARA-R410M-02B-02.

⁵¹ The **+ULWM2MREG** AT command is not supported by SARA-R410M-02B-00, SARA-R410M-02B-01, SARA-R410M-02B-02.

| | Telstra | China Telecom |
|--------------------------------|----------|---------------|
| +USVCDOMAIN | | |
| Service domain | CS+PS | CS+PS |
| +UMACQOSTMR | | |
| LTE Cat M1 timer ⁵² | 35 s | n/a |
| NB-IoT timer ⁵² | Disabled | n/a |
| Locked ⁵² | No | n/a |

⁵² The **+UMACQOSTMR** AT command is not supported by SARA-R410M-02B-00, SARA-R410M-02B-01, SARA-R410M-02B-02.

C.6 SARA-R410M-02B EMEA MNO profiles table

| | Vodafone | Deutsche Telekom | Orange France | Standard Europe |
|-----------------------------------|-----------------------|--------------------|-------------------|--------------------|
| MNO profile | | | | |
| <MNO> | 19 ⁵³ | 31 ⁵⁴ | 46 ⁵⁵ | 100 ⁵⁶ |
| Version | 8.0 ⁵⁷ | 8.0 ⁵⁸ | 8.0 | 8.0 ⁵⁹ |
| +UBANDMASK | | | | |
| LTE-M bands [decimal value] | 3, 8, 20 [524420] | 3, 8, 20 [524420] | 3, 8, 20 [524420] | 3, 8, 20 [524420] |
| NB-IoT bands [decimal value] | 3, 8, 20 [524420] | 3, 8, 20 [524420] | 3, 8, 20 [524420] | 3, 8, 20 [524420] |
| Locked | No | No | No | No |
| +URAT | | | | |
| Allowed values | NB-IoT, LTE Cat M1 | LTE Cat M1, NB-IoT | LTE Cat M1 | LTE Cat M1, NB-IoT |
| Locked | No | No | No | No |
| +CPSMS | | | | |
| Enabled | True | True | True | True |
| T3324 | 6 s | 30 s | 16 s | 6 s |
| T3412_ext | 11400 s | 1116000 s | 10800 s | 11400 s |
| Locked | No | No | No | No |
| +CEDRXS | | | | |
| Enabled | False | True | True | True |
| Paging time window | 7 | 1 | 8 | 1 |
| eDRX cycle length | 2 | 2 | 5 | 2 |
| Locked | No | No | No | No |
| +CGDCONT | | | | |
| Data profile 1 | IPV4V6, ⁶⁰ | empty | empty | empty |
| Data profile 2 | empty | empty | empty | empty |
| Data profile 3 | empty | empty | empty | empty |
| Data profile 4 | empty | empty | empty | empty |
| Data profile 6 | empty | empty | empty | empty |
| LwM2M feature⁶¹ | | | | |
| Available | Yes | Yes | Yes | Yes |
| LwM2M capabilities | u-blox | u-blox | u-blox | u-blox |
| uFOTA-LwM2M capabilities | uFOTA | uFOTA | uFOTA | uFOTA |
| +ULWLM2MREG | | | | |

⁵³ <MNO>=19 (Vodafone) is not supported by SARA-R410M-02B-00.

⁵⁴ <MNO>=31 (Deutsche Telekom) is not supported by SARA-R410M-02B-00.

⁵⁵ <MNO>=46 (Orange France) is not supported by SARA-R410M-02B-00, SARA-R410M-02B-01, SARA-R410M-02B-02.

⁵⁶ <MNO>=100 (Standard Europe) is not supported by SARA-R410M-02B-00.

⁵⁷ On SARA-R410M-02B-02 the <MNO>=19 (Vodafone) profile version is 7.1. On SARA-R410M-02B-01 the <MNO>=19 (Vodafone) profile version is 7.0.

⁵⁸ On SARA-R410M-02B-02 the <MNO>=31 (Deutsche Telekom) profile version is 7.1. On SARA-R410M-02B-01 the <MNO>=31 (Deutsche Telekom) profile version is 7.0.

⁵⁹ On SARA-R410M-02B-02 the <MNO>=100 (Standard Europe) profile version is 7.1. On SARA-R410M-02B-01 the <MNO>=100 (Standard Europe) profile version is 7.0.

⁶⁰ On SARA-R410M-02B-01, SARA-R410M-02B-02 by factory-programmed configuration the data profile 1 is set to: IP, "".

⁶¹ The LwM2M feature is not supported by SARA-R410M-02B-00, SARA-R410M-02B-01, SARA-R410M-02B-02.

| | Vodafone | Deutsche Telekom | Orange France | Standard Europe |
|-----------------------------------|----------|------------------|---------------|-----------------|
| Supported server ID ⁶² | 721 | 721 | 721 | 721 |
| Locked ⁶² | No | No | No | No |
| +USVCDOMAIN | | | | |
| Service domain | PS | PS | CS+PS | PS |
| +UMACQOSTMR | | | | |
| LTE Cat M1 timer ⁶³ | 35 s | 35 s | 35 s | 35 s |
| NB-IoT timer ⁶³ | Disabled | Disabled | Disabled | Disabled |
| Locked ⁶³ | No | No | No | No |

⁶² The **+ULWM2MREG** AT command is not supported by SARA-R410M-02B-00, SARA-R410M-02B-01, SARA-R410M-02B-02.

⁶³ The **+UMACQOSTMR** AT command is not supported by SARA-R410M-02B-00, SARA-R410M-02B-01, SARA-R410M-02B-02.

C.7 SARA-R410M-52B Americas MNO profiles table

| | Undefined | AT&T | Verizon |
|---------------------------------|---|------------------------|--------------------------------------|
| MNO profile | | | |
| <MNO> | 0 | 2 | 3 |
| Version | n/a | 6.7 ⁶⁴ | 6.5 ⁶⁵ |
| +UBANDMASK | | | |
| LTE-M bands [decimal value] | 2, 4, 5, 12, 13 [6170] ⁶⁶ | 2, 4, 5, 12 [2074] | 13 [4096] |
| NB-IoT bands [decimal value] | n/a | n/a | n/a |
| Locked | Yes ⁶⁷ | Yes ⁶⁷ | Yes ⁶⁷ |
| +URAT | | | |
| Allowed values | LTE Cat M1 | LTE Cat M1 | LTE Cat M1 |
| Locked | Yes ⁶⁸ | Yes ⁶⁸ | Yes ⁶⁸ |
| +CPSMS | | | |
| Enabled | False | False ⁶⁹ | False |
| T3324 | 6 s | 6 s | 6 s |
| T3412_ext | 150 s | 150 s | 150 s |
| Locked | No | No | No |
| +CEDRXS | | | |
| Enabled | True | False ⁷⁰ | False |
| Paging time window | 7 | 7 | 7 |
| eDRX cycle length | 9 | 9 | 9 |
| Locked | No | No | No |
| +CGDCONT | | | |
| Data profile 1 | empty | IPV4V6," ⁷¹ | IPV4V6," ⁷² |
| Data profile 2 | empty | empty | IPV4V6, "vzwadmin" ⁷³ |
| Data profile 3 | empty | empty | IPV4V6, "vzwinternet" |
| Data profile 4 | empty | empty | IPV4V6, "vzwapp" ⁷⁴ |
| Data profile 6 | empty | empty | IPV4V6, "vzwclass6" ⁷⁵ |

⁶⁴ On SARA-R410M-52B-01 the <MNO>=2 (AT&T) profile version is 6.6. On SARA-R410M-52B-00 the <MNO>=2 (AT&T) profile version is n/a.

⁶⁵ On SARA-R410M-52B-01 the <MNO>=3 (Verizon) profile version is 6.4. On SARA-R410M-52B-00 the <MNO>=3 (Verizon) profile version is n/a.

⁶⁶ On SARA-R410M-52B-00 the LTE-M bands enabled by factory-programmed configuration are: 1, 2, 3, 4, 5, 8, 12, 13, 20, 28 [134748319].

⁶⁷ On SARA-R410M-52B-00 the **+UBANDMASK** AT command setting is not locked.

⁶⁸ On SARA-R410M-52B-00 the **+URAT** AT command setting is not locked.

⁶⁹ On SARA-R410M-52B-01 by factory-programmed configuration the PSM is enabled (see **+CPSMS**).

⁷⁰ On SARA-R410M-52B-00 by factory-programmed configuration the use of eDRX is enabled (see **+CEDRXS**).

⁷¹ On SARA-R410M-52B-00 and SARA-R410M-52B-01 by factory-programmed configuration the data profile 1 is set to: IPV4V6,"phone".

⁷² On SARA-R410M-52B-00 by factory-programmed configuration the data profile 1 is set to: IPV4V6, "VZWIMS".

⁷³ On SARA-R410M-52B-00 by factory-programmed configuration the data profile 2 is set to: IPV4V6, "VZWADMIN".

⁷⁴ On SARA-R410M-52B-00 by factory-programmed configuration the data profile 4 is an empty profile.

⁷⁵ On SARA-R410M-52B-01 by factory-programmed configuration the data profile 6 is an empty profile. On SARA-R410M-52B-00 by factory-programmed configuration the data profile 6 is set to: IPV6, "VZWCLASS6".

| | Undefined | AT&T | Verizon |
|--------------------|-----------|-------|---------|
| +USVCDOMAIN | | | |
| Service domain | CS+PS | CS+PS | CS+PS |

C.8 SARA-R410M-63B / SARA-R410M-73B / SARA-R410M-83B Americas MNO profiles table

| Undefined | |
|---------------------------------|---|
| MNO profile | |
| <MNO> | 0 |
| Version | n/a |
| +UBANDMASK | |
| LTE-M bands [decimal value] | 1, 2, 3, 4, 5, 8, 12, 13, 18, 19, 20, 25, 26, 28 [185473183] ⁷⁶ |
| NB-IoT bands [decimal value] | 1, 2, 3, 4, 5, 8, 12, 13, 18, 19, 20, 25, 26, 28 [185473183] ⁷⁷ |
| Locked | No |
| +URAT | |
| Allowed values | LTE Cat M1, NB-IoT ⁷⁸ |
| Locked | No |
| +CPSMS | |
| Enabled | False |
| T3324 | 6 s |
| T3412_ext | 150 s |
| Locked | No |
| +CEDRXS | |
| Enabled | False |
| Paging time window | 7 |
| eDRX cycle length | 9 |
| Locked | No |
| +CGDCONT | |
| Data profile 1 | empty |
| Data profile 2 | empty |
| Data profile 3 | empty |
| Data profile 4 | empty |
| Data profile 6 | empty |
| LwM2M feature | |
| Available | No |
| LwM2M capabilities | n/a |
| uFOTA-LwM2M capabilities | n/a |
| +ULWM2MREG | |
| Supported server ID | 0 |
| Locked | No |
| +USVCDOMAIN | |
| Service domain | CS+PS |
| +CCIOTOPT | |
| CP EPS Optimization | Disabled |
| UP EPS Optimization | Disabled |

⁷⁶ On SARA-R410M-73B-00 the LTE-M bands enabled by factory-programmed configuration are: 1, 3, 5, 8, 19, 26 [33816725]

⁷⁷ On SARA-R410M-73B-00 all the NB-IoT bands are disabled by factory-programmed configuration.

⁷⁸ On SARA-R410M-73B-00 only LTE Cat M1 is enabled by factory-programmed configuration.

| | |
|--------|------------------|
| | Undefined |
| Locked | No |

C.9 SARA-R410M-63B / SARA-R410M-73B / SARA-R410M-83B APAC MNO profiles table

| | Telstra | NTT DoCoMo | SoftBank | SKT | Standard JP (global) |
|------------------------------|----------------------------|-------------------|-------------------|---------------------|----------------------|
| MNO profile | | | | | |
| <MNO> | 4 ⁷⁹ | 20 ⁸⁰ | 28 ⁸¹ | 39 ⁸² | 102 ⁸³ |
| Version | 7.5 ⁸⁴ | 6.9 ⁸⁵ | 6.9 ⁸⁶ | 6.13 ⁸⁷ | 6.9 |
| +UBANDMASK | | | | | |
| LTE-M bands [decimal value] | 3, 5, 8, 28 [134217876] | 1, 19 [262145] | 1, 8 [129] | 3, 5, 26 [33554452] | 1, 8, 19 [262273] |
| NB-IoT bands [decimal value] | 3, 5, 8, 28 [134217876] | n/a | n/a | n/a | n/a |
| Locked | No | No | No | No | No |
| +URAT | | | | | |
| Allowed values | LTE Cat M1, NB-IoT | LTE Cat M1 | LTE Cat M1 | LTE Cat M1 | LTE Cat M1 |
| Locked | No | No | No | No | No |
| +CPSMS | | | | | |
| Enabled | False | False | True | False | False |
| T3324 | 60 s | 6 s | 6 s | 6 s | 6 s |
| T3412_ext | 86400 s | 150 s | 150 s | 150 s | 150 s |
| Locked | No | No | No | No | No |
| +CEDRXS | | | | | |
| Enabled | False | True | True | False | True |
| Paging time window | 7 | 7 | 7 | 6 | 7 |
| eDRX cycle length | 2 | 9 | 9 | 9 | 9 |
| Locked | No | No | No | No | No |
| +CGDCONT | | | | | |
| Data profile 1 | IPV4V6, "telstra.internet" | empty | IPV4V6, "" | empty | empty |
| Data profile 2 | empty | empty | empty | empty | empty |
| Data profile 3 | empty | empty | empty | empty | empty |
| Data profile 4 | empty | empty | empty | empty | empty |
| Data profile 6 | empty | empty | empty | empty | empty |
| LwM2M feature | | | | | |
| Available | Yes | Yes | Yes | Yes | Yes |
| LwM2M capabilities | u-blox | DoCoMo | u-blox | u-blox | u-blox |
| uFOTA-LwM2M capabilities | uFOTA | DoCoMo | uFOTA | uFOTA | uFOTA |
| +ULWM2MREG | | | | | |
| Supported server ID | 721 | 0, 123 | 721 | 721 | 721 |

⁷⁹ <MNO>=4 (Telstra) is not supported by SARA-R410M-63B and SARA-R410M-73B.

⁸⁰ <MNO>=20 (NTT DoCoMo) is not supported by SARA-R410M-73B-01, SARA-R410M-83B-00, SARA-R410M-83B-01.

⁸¹ <MNO>=28 (SoftBank) is not supported by SARA-R410M-73B-01, SARA-R410M-83B-00, SARA-R410M-83B-01.

⁸² <MNO>=39 (SKT) is not supported by SARA-R410M-63B-01, SARA-R410M-83B-00, SARA-R410M-83B-01.

⁸³ <MNO>=102 (Standard JP (Global)) is not supported by SARA-R410M-63B-00, SARA-R410M-73B-00, SARA-R410M-73B-01, SARA-R410M-83B-00, SARA-R410M-83B-01.

⁸⁴ On SARA-R410M-83B-00 the <MNO>=4 (Telstra) profile version is 7.4.

⁸⁵ On SARA-R410M-63B-00 and SARA-R410M-73B-00 the <MNO>=20 (NTT DoCoMo) profile version is 6.7.

⁸⁶ On SARA-R410M-63B-00 and SARA-R410M-73B-00 the <MNO>=28 (SoftBank) profile version is 6.7.

⁸⁷ On SARA-R410M-63B-00 and SARA-R410M-73B-00 the <MNO>=39 (SKT) profile version is 6.10.

| | Telstra | NTT DoCoMo | SoftBank | SKT | Standard JP (global) |
|---------------------|----------|------------|----------|-------|----------------------|
| Locked | No | No | No | No | No |
| +USVCDOMAIN | | | | | |
| Service domain | CS+PS | CS+PS | CS+PS | CS+PS | CS+PS |
| +CCIOTOPT | | | | | |
| CP EPS Optimization | Disabled | n/a | n/a | n/a | n/a |
| UP EPS Optimization | Disabled | n/a | n/a | n/a | n/a |
| Locked | No | No | No | No | No |

C.10 SARA-R410M-83B EMEA MNO profile table

| | Standard Europe |
|---------------------------------|----------------------|
| MNO profile | |
| <MNO> | 100 |
| Version | 6.5 ⁸⁸ |
| +UBANDMASK | |
| LTE-M bands [decimal value] | 3, 8, 20 [524420] |
| NB-IoT bands [decimal value] | 3, 8, 20 [524420] |
| Locked | No |
| +URAT | |
| Allowed values | LTE Cat M1, NB-IoT |
| Locked | No |
| +CPSMS | |
| Enabled | True |
| T3324 | 60 s |
| T3412_ext | 11400 s |
| Locked | No |
| +CEDRXS | |
| Enabled | True |
| Paging time window | 1 |
| eDRX cycle length | 2 |
| Locked | No |
| +CGDCONT | |
| Data profile 1 | empty |
| Data profile 2 | empty |
| Data profile 3 | empty |
| Data profile 4 | empty |
| Data profile 6 | empty |
| LwM2M feature | |
| Available | Yes |
| LwM2M capabilities | u-blox |
| uFOTA-LwM2M capabilities | uFOTA |
| +ULWM2MREG | |
| Supported server ID | 721 |
| Locked | No |
| +USVCDOMAIN | |
| Service domain | PS |
| +CCIOTOPT | |
| CP EPS Optimization | Disabled |
| UP EPS Optimization | Disabled |
| Locked | No |

⁸⁸ On SARA-R410M-83B-00 the <MNO>=100 (Standard Europe) profile version is 6.2.

C.11 SARA-R412M Americas MNO profiles table

| | Undefined | AT&T | T-Mobile US | VIVO | Claro Brasil |
|-------------------------------------|--|------------------------|---------------------|-------------------------------|-------------------------------|
| MNO profile | | | | | |
| <MNO> | 0 | 2 ⁸⁹ | 5 ⁹⁰ | 33 ⁹¹ | 44 ⁹² |
| Version | n/a | 8.1 ⁹³ | 7.1 | 8.1 | 8.1 |
| +UBANDMASK | | | | | |
| LTE-M bands [decimal value] | 2, 3, 4, 5, 8, 12, 20 [526494] ⁹⁴ | 2, 4, 5, 12 [2074] | n/a | 3, 28 [134217732] | 3, 28 [134217732] |
| NB-IoT bands [decimal value] | 2, 3, 4, 5, 8, 12, 20 [526494] ⁹⁵ | n/a | 2, 4, 5, 12 [2074] | 28 [134217728] | 3, 5, 28 [134217748] |
| Locked | Yes ⁹⁶ | No | No | No | No |
| +URAT | | | | | |
| Allowed values | LTE Cat M1, NB-IoT, GPRS/eGPRS ⁹⁷ | LTE Cat M1, GPRS/eGPRS | NB-IoT, GPRS/eGPRS | LTE Cat M1, NB-IoT | LTE Cat M1, NB-IoT |
| Locked | Yes ⁹⁸ | No | No | No | No |
| +CPSMS | | | | | |
| Enabled | False | True | False | True | True |
| T3324 | 6 s | 6 s | 6 s | 180 s | 180 s |
| T3412_ext | 150 s | 150 s | 150 s | 14400 s | 5760 s |
| Locked | No | No | No | No | No |
| +CEDRXS | | | | | |
| Enabled | False ⁹⁹ | False | False | True | True |
| Paging time window | 7 | 7 | 7 | 7 | 5 |
| eDRX cycle length | 9 | 9 | 9 | 9 | 163 |
| Locked | No | No | No | No | No |
| +CGDCONT | | | | | |
| Data profile 1 | empty | IPV4V6," " | empty | IPV4V6, "kiteiot.vivo.com.br" | IPV4V6, "cat-m1.claro.com.br" |
| Data profile 2 | empty | empty | IPV6,"iot.nb" | empty | IPV4V6, "nbiot.claro.com.br" |
| Data profile 3 | empty | empty | NONIP,"iot.nb.nidd" | empty | IPV4V6, "iot.claro.com.br" |
| Data profile 4 | empty | empty | empty | empty | empty |
| Data profile 6 | empty | empty | empty | empty | empty |
| LwM2M feature ¹⁰⁰ | | | | | |
| Available | No | Yes | n/a | Yes | Yes |

⁸⁹ <MNO>=2 (AT&T) is not supported by SARA-R412M-02B-00, SARA-R412M-02B-02.

⁹⁰ <MNO>=5 (T-Mobile US) is not supported by SARA-R412M-02B-00, SARA-R412M-02B-02, SARA-R412M-02B-03.

⁹¹ <MNO>=33 (VIVO) is not supported by SARA-R412M-02B-00, SARA-R412M-02B-01, SARA-R412M-02B-02.

⁹² <MNO>=44 (Claro Brasil) is not supported by SARA-R412M-02B-00, SARA-R412M-02B-01, SARA-R412M-02B-02.

⁹³ On SARA-R412M-02B-01 the <MNO>=2 (AT&T) profile version is 7.2.

⁹⁴ On SARA-R412M-02B-00 the LTE-M bands enabled by factory-programmed configuration are: 1, 3, 5, 8, 19, 26 [33816725].

⁹⁵ On SARA-R412M-02B-00 all the NB-IoT bands are disabled by factory-programmed configuration.

⁹⁶ On SARA-R412M-02B-00 the **+UBANDMASK** AT command setting is not locked.

⁹⁷ On SARA-R412M-02B-00 only LTE Cat M1 is enabled by factory-programmed configuration.

⁹⁸ On SARA-R412M-02B-00 the **+URAT** AT command setting is not locked.

⁹⁹ On SARA-R412M-02B-00 by factory-programmed configuration the use of eDRX is enabled (see **+CEDRXS**).

¹⁰⁰ The LwM2M feature is not supported by SARA-R412M-02B-00, SARA-R412M-02B-01, SARA-R412M-02B-02.

| | Undefined | AT&T | T-Mobile US | VIVO | Claro Brasil |
|-------------------------------------|----------------------------|--------------|-------------|----------|--------------|
| LwM2M capabilities | n/a | u-blox, AT&T | n/a | u-blox | u-blox |
| uFOTA-LwM2M capabilities | n/a | uFOTA | n/a | uFOTA | uFOTA |
| +ULWM2MREG | | | | | |
| Supported server ID ¹⁰¹ | 0 | 0, 3, 721 | n/a | 721 | 721 |
| Locked ¹⁰¹ | No | No | n/a | No | No |
| +USVCDOMAIN | | | | | |
| Service domain | CS+PS | CS+PS | PS | CS+PS | CS+PS |
| +UMACQOSTMR | | | | | |
| LTE Cat M1 timer ¹⁰² | 35 s | 35 s | n/a | 35 s | 35 s |
| NB-IoT timer ¹⁰² | Disabled | Disabled | n/a | Disabled | Disabled |
| Locked ¹⁰² | No | No | n/a | No | No |
| TIM Brasil | | | | | |
| MNO profile | | | | | |
| <MNO> | 45 ¹⁰³ | | | | |
| Version | 8.0 | | | | |
| +UBANDMASK | | | | | |
| LTE-M bands [decimal value] | n/a | | | | |
| NB-IoT bands [decimal value] | 3, 28 [134217732] | | | | |
| Locked | No | | | | |
| +URAT | | | | | |
| Allowed values | NB-IoT | | | | |
| Locked | No | | | | |
| +CPSMS | | | | | |
| Enabled | True | | | | |
| T3324 | 6 s | | | | |
| T3412_ext | 150 s | | | | |
| Locked | No | | | | |
| +CEDRXS | | | | | |
| Enabled | True | | | | |
| Paging time window | 7 | | | | |
| eDRX cycle length | 9 | | | | |
| Locked | No | | | | |
| +CGDCONT | | | | | |
| Data profile 1 | IPV4V6, "nbiot" | | | | |
| Data profile 2 | IPV4V6, "timbrasil.com.br" | | | | |
| Data profile 3 | empty | | | | |
| Data profile 4 | empty | | | | |
| Data profile 6 | empty | | | | |
| LwM2M feature ¹⁰⁴ | | | | | |
| Available | Yes | | | | |

¹⁰¹ The **+ULWM2MREG** AT command is not supported by SARA-R412M-02B-00, SARA-R412M-02B-01, SARA-R412M-02B-02.

¹⁰² The **+UMACQOSTMR** AT command is not supported by SARA-R412M-02B-00, SARA-R412M-02B-01, SARA-R412M-02B-02.

¹⁰³ <MNO>=45 (TIM Brasil) is not supported by SARA-R412M-02B-00, SARA-R412M-02B-01, SARA-R412M-02B-02.

¹⁰⁴ The LwM2M feature is not supported by SARA-R412M-02B-00, SARA-R412M-02B-01, SARA-R412M-02B-02.

| TIM Brasil | |
|------------------------------------|----------|
| LwM2M capabilities | u-blox |
| uFOTA-LwM2M capabilities | uFOTA |
| +ULWM2MREG | |
| Supported server ID ¹⁰⁵ | 721 |
| Locked ¹⁰⁵ | No |
| +USVCDOMAIN | |
| Service domain | CS+PS |
| +UMACQOSTMR | |
| LTE Cat M1 timer ¹⁰⁶ | 35 s |
| NB-IoT timer ¹⁰⁶ | Disabled |
| Locked ¹⁰⁶ | No |

¹⁰⁵ The **+ULWM2MREG** AT command is not supported by SARA-R412M-02B-00, SARA-R412M-02B-01, SARA-R412M-02B-02.

¹⁰⁶ The **+UMACQOSTMR** AT command is not supported by SARA-R412M-02B-00, SARA-R412M-02B-01, SARA-R412M-02B-02.

C.12 SARA-R412M EMEA profiles table

| | Vodafone | Deutsche Telekom | Orange France | Standard Europe |
|------------------------------------|--------------------------------|--------------------------------|------------------------|--------------------------------|
| MNO profile | | | | |
| <MNO> | 19 | 31 | 46 | 100 |
| Version | 8.1 ¹⁰⁷ | 8.1 ¹⁰⁸ | 8.1 | 8.1 ¹⁰⁹ |
| +UBANDMASK | | | | |
| LTE-M bands [decimal value] | 3, 8, 20 [524420] | 3, 8, 20 [524420] | 3, 8, 20 [524420] | 3, 8, 20 [524420] |
| NB-IoT bands [decimal value] | 3, 8, 20 [524420] | 3, 8, 20 [524420] | 3, 8, 20 [524420] | 3, 8, 20 [524420] |
| Locked | No | No | No | No |
| +URAT | | | | |
| Allowed values | NB-IoT, GPRS/eGPRS, LTE Cat M1 | LTE Cat M1, NB-IoT, GPRS/eGPRS | LTE Cat M1, GPRS/eGPRS | LTE Cat M1, NB-IoT, GPRS/eGPRS |
| Locked | No | No | No | No |
| +CPSMS | | | | |
| Enabled | True | True | True | True |
| T3324 | 6 s | 30 s | 16 s | 6 s ¹¹⁰ |
| T3412_ext | 11400 s | 1116000 s | 10800 s | 11400 s |
| Locked | No | No | No | No |
| +CEDRXS | | | | |
| Enabled | False ¹¹¹ | True | True | True |
| Paging time window | 7 | 1 | 8 | 1 |
| eDRX cycle length | 2 | 2 | 5 | 2 |
| Locked | No | No | No | No |
| +CGDCONT | | | | |
| Data profile 1 | IP, "" | empty | empty | empty |
| Data profile 2 | empty | empty | empty | empty |
| Data profile 3 | empty | empty | empty | empty |
| Data profile 4 | empty | empty | empty | empty |
| Data profile 6 | empty | empty | empty | empty |
| LwM2M feature¹¹² | | | | |
| Available | Yes | Yes | Yes | Yes |
| LwM2M capabilities | u-blox | u-blox | u-blox | u-blox |
| uFOTA-LwM2M capabilities | uFOTA | uFOTA | uFOTA | uFOTA |
| +ULWM2MREG | | | | |

¹⁰⁷ On SARA-R412M-02B-02 the <MNO>=19 (Vodafone) profile version is 7.3. On SARA-R412M-02B-01 the <MNO>=19 (Vodafone) profile version is 7.1. On SARA-R412M-02B-00 the <MNO>=19 (Vodafone) profile version is 6.2.

¹⁰⁸ On SARA-R412M-02B-02 the <MNO>=31 (Deutsche Telekom) profile version is 7.3. On SARA-R412M-02B-01 the <MNO>=31 (Deutsche Telekom) profile version is 7.1. On SARA-R412M-02B-00 the <MNO>=31 (Deutsche Telekom) profile version is 6.3.

¹⁰⁹ On SARA-R412M-02B-02 the <MNO>=100 (Standard Europe) profile version is 7.3. On SARA-R412M-02B-01 the <MNO>=100 (Standard Europe) profile version is 7.1. On SARA-R412M-02B-00 the <MNO>=100 (Standard Europe) profile version is 6.2.

¹¹⁰ On SARA-R412M-02B-00 by factory-programmed configuration the T3324 is set to 60 s.

¹¹¹ On SARA-R412M-02B-00 by factory-programmed configuration the use of eDRX is enabled (see **+CEDRXS**).

¹¹² The LwM2M feature is not supported by SARA-R412M-02B-00, SARA-R412M-02B-01, SARA-R412M-02B-02.

| | Vodafone | Deutsche Telekom | Orange France | Standard Europe |
|------------------------------------|----------|-------------------|---------------|-----------------|
| Supported server ID ¹¹³ | 721 | 721 | 721 | 721 |
| Locked ¹¹³ | No | No | No | No |
| +USVCDOMAIN | | | | |
| Service domain | PS | PS ¹¹⁴ | CS+PS | PS |
| +UMACQOSTMR | | | | |
| LTE Cat M1 timer ¹¹⁵ | 35 s | 35 s | 35 s | 35 s |
| NB-IoT timer ¹¹⁵ | Disabled | Disabled | Disabled | Disabled |
| Locked ¹¹⁵ | No | No | No | No |

¹¹³ The **+ULWM2MREG** AT command is not supported by SARA-R412M-02B-00, SARA-R412M-02B-01, SARA-R412M-02B-02.

¹¹⁴ On SARA-R412M-02B-00 by factory-programmed configuration the service domain is set to CS+PS (see **+USVCDOMAIN**).

¹¹⁵ The **+UMACQOSTMR** AT command is not supported by SARA-R412M-02B-00, SARA-R412M-02B-01, SARA-R412M-02B-02.

D Appendix: UDP Direct Link workflow

D.1 Data from the IP network to the external port

When a UDP data packet is received from the network, its payload is forwarded through the external port as soon as possible (according to the HW flow control, if any).

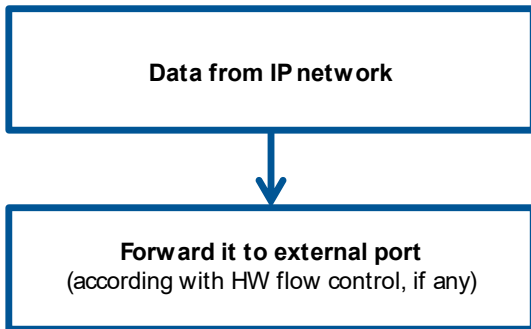

Figure 10: Workflow of data from the IP network to the external port

D.2 Data from the external port to the IP network

When some data comes from the external port, there are 2 parameters involved:

1. The UDP DL packet size (factory-programmed: 1024 bytes; valid range 100-1472)
2. The UDP DL sending timer delay (factory-programmed: 1000 ms; valid range 100-120000)

Both parameters are specific for each socket and could be modified by the user. These values are not saved into the NVM and if not specified, the factory-programmed values are used.

There are 3 different cases that may occur while receiving data from the external port in UDP DL mode:

1. The received data from the external port is equal to the UDP DL packet size: the received data is immediately sent to the network
2. The received data from the external port is more than the UDP DL packet size: the amount of data till UDP DL packet size is immediately sent to the network, the remaining data is saved into an intermediate buffer.
3. The received data from the external port is less than UDP DL packet size: the received data is saved into an intermediate buffer and sent to the network when the UDP DL sending timer expires. The timer is reset (it restarts the countdown) every time new data is received from the external port, this means that the data will be sent to the network after N ms (default 1000 ms) since the last received byte.



The data sent from the serial port is not echoed to the sender.



The configuration of UDP DL packet size and UDP DL sending timer are NOT saved in NVM.

The following diagram shows how the events of external data input and sending timer expire are handled.

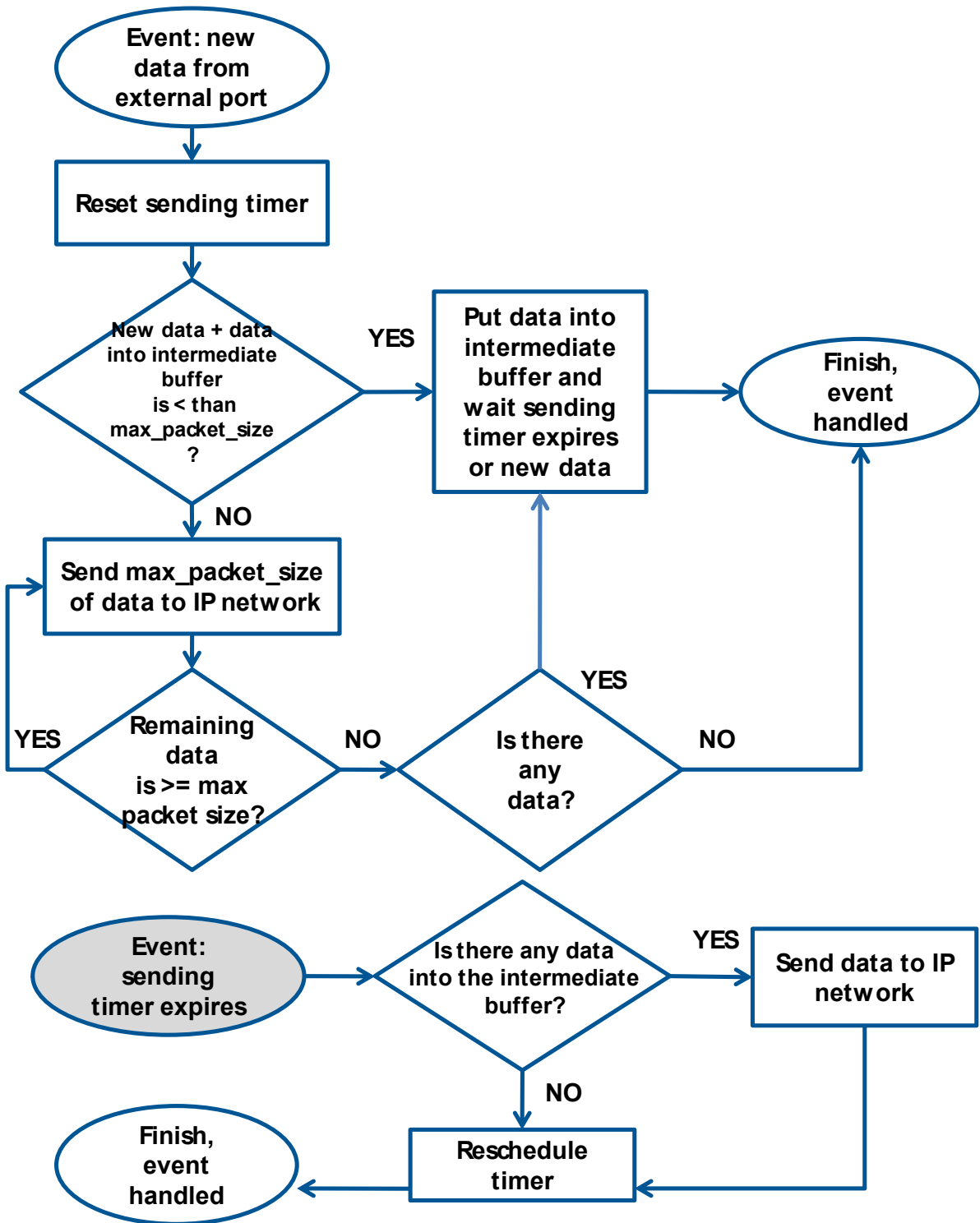

Figure 11: Workflow of data from the external port to the IP network

E Appendix: glossary

| Abbreviation | Definition |
|------------------------|--|
| 2G | 2nd Generation |
| 3G | 3rd Generation |
| 3GPP | 3rd Generation Partnership Project |
| ADC | Analog to Digital Converter |
| AleC | Automatically Initiated eCall |
| ADN | Abbreviated Dialing Numbers |
| AMR | Adaptive Multi Rate |
| AP | Access Point |
| APN | Access Point Name |
| ASCII | American Standard Code for Information Interchange |
| AT | AT Command Interpreter Software Subsystem, or attention |
| BL | Black List |
| BSD | Berkley Standard Distribution |
| CB | Cell Broadcast |
| CBM | Cell Broadcast Message |
| CLI | Calling Line Identification |
| CLIP | Calling Line Identification Presentation |
| CLIR | Calling Line Identification Restriction |
| COLP | Connected Line Identification Presentation |
| COLR | Connected Line Identification Restriction |
| CM | Connection Management |
| CPHS | Common PCN Handset Specification |
| CR | Carriage Return |
| CS | Circuit Switch |
| CSD | Circuit-Switched Data |
| CSG | Closed Subscriber Group |
| CTS | Clear To Send |
| CUG | Closed User Group |
| DA | Destination Address |
| DARP | Downlink Advanced Receiver Performance |
| DCD | Data Carrier Detect |
| DCE | Data Communication Equipment |
| DCM | Data Connection Management |
| DHCP | Dynamic Host Configuration Protocol |
| DM | Device Management |
| DNS | Domain Name Server |
| DSR | DSC transponder response |
| DTE, TE | Data Terminal Equipment |
| DTMF | Dual Tone Multi Frequency |
| DTR | Data Terminal Ready |
| DUT | Device Under Test |
| EARFCN | E-UTRAN Absolute Radio Frequency Channel Number |
| eCall | Emergency Call |
| e-CDRX | Extended Connected Mode DRX |
| eDRX | Extended Discontinuous Reception |
| EEP | EEPROM Emulation Parameters |
| EF | Elementary File |
| EF _{CGST} | Elementary File "Closed Subscriber Group Type" |
| EF _{HNB} | Elementary File "Home Node B Number" |
| EF _{PLMNwAcT} | Elementary File "User controlled PLMN Selector with Access Technology" |
| eIM | eCall In-band Modem |
| EONS | Enhanced Operator Name from SIM-files EF _{OP} L and EF _{PNN} |

| Abbreviation | Definition |
|------------------|---|
| EPD | Escape Prompt Delay |
| EPS | Evolved Packet System |
| ETSI | European Telecommunications Standards Institute |
| E-UTRAN/EUTRAN | Evolved UTRAN |
| FDN | Fixed Dialling Number |
| FOAT | Firmware Over AT |
| FOTA | Firmware Over The Air |
| FS | File System |
| FTP | File Transfer Protocol |
| FW | Firmware |
| FWINSTALL | Firmware Install |
| GAS | Grouping information Alpha String |
| GERAN | GSM/EDGE Radio Access Network |
| GPIO | General Purpose Input Output |
| GPRS | General Packet Radio Service |
| GPS | Global Positioning System |
| GSM | Global System for Mobile Communications |
| HDLC | High Level Data Link Control |
| HNB | Home Node B |
| HPLMN | Home PLMN |
| HTTP | HyperText Transfer Protocol |
| I | Information |
| I ² C | Inter-Integrated Circuit |
| I ² S | Inter IC Sound or Integrated Interchip Sound |
| ICCID | Integrated Circuit Card ID |
| ICMP | Internet Control Message Protocol |
| ICP | Inter Processor Communication |
| IMEI | International Mobile Equipment Identity |
| IMS | IP Multimedia Subsystem |
| IMSI | International Mobile Station Identity |
| InBM | In-Band Modem (generic) |
| IP | Internet Protocol |
| IRA | International Reference Alphabet |
| IRC | Intermediate Result Code |
| ISDN | Integrated Services Digital Network |
| ISP | Internet Service Provider |
| IVS | In-Vehicle System (eCall related) |
| L3 | Layer 3 |
| LCP | Link Control Protocol |
| LF | Line Feed |
| LNS | Linux Network Subsystem |
| LwM2M | Lightweight M2M |
| M2M | Machine-To-Machine |
| MCC | Mobile Country Code |
| ME | Mobile Equipment |
| MieC | Manually Initiated eCall |
| MMI | Man Machine Interface |
| MN | Mobile Network Software Subsystem |
| MNC | Mobile Network Code |
| MNO | Mobile Network Operator |
| MO | Mobile Originated |
| MS | Mobile Station |
| MSC | Modem Status Command |
| MSD | Minimum Set of Data (eCall related) |
| MSIN | Mobile Subscriber Identification Number |

| Abbreviation | Definition |
|--------------|---|
| MSISDN | Mobile Systems International Subscriber Identity Number |
| MSPR | Multi-Slot Power Reduction |
| MT | Mobile Terminated |
| MWI | Message Waiting Indication |
| NAA | Network Access Application |
| NAS | Non Access Stratum |
| NITZ | Network Identity and Time Zone |
| NVM | Non-Volatile Memory |
| ODIS | OMA-DM IMEI Sync |
| OLCM | On Line Commands Mode |
| PAD | Packet Assembler/Disassembler |
| P-CID | Physical Cell Id |
| PCN | Personal Communication Network |
| PDP | Packet Data Protocol |
| PDU | Protocol Data Unit |
| PIN | Personal Identification Number |
| PLMN | Public Land Mobile Network |
| PPP | Point-to-Point Protocol |
| PSAP | Public Safety Answering Point (eCall related) |
| PSD | Packet-Switched Data |
| PUK | Personal Unblocking Key |
| QoS | Quality of Service |
| RAM | Random Access Memory |
| RDI | Restricted Digital Information |
| RFU | Reserved for Future Use |
| RI | Ring Indicator |
| RNDIS | Remote Network Driver Interface Specification |
| RRC | Radio resource control |
| RTC | Real Time Clock |
| RTP | Real-time Transport Protocol |
| RTS | Request To Send |
| Rx | Receiver |
| SAP | SIM Access Profile |
| SC | Service Centre |
| SI | SIM Application Part Software Subsystem |
| SIP | Session Initiation Protocol |
| SIM | Subscriber Identity Module |
| SMS | Short Message Service |
| SMSC | Short Message Service Center |
| SMTP | Simple Mail Transfer Protocol |
| SoR | Steering of Roaming |
| SDIO | Secure Digital Input Output |
| SES | Speech Enhancement System |
| STA | station |
| SSID | Service Set Identifier |
| TA | Terminal Adaptor |
| TCP | Transfer Control Protocol |
| TE | Terminal Equipment |
| TFT | Traffic Flow Template |
| TP | Transfer layer Protocol |
| Tx | Transmitter |
| TZ | Time Zone |
| UCS2 | Universal Character Set |
| UDI | Unrestricted Digital Information |
| UDP | User Datagram Protocol |

| Abbreviation | Definition |
|---------------------|---|
| UI | Unnumbered Information |
| UICC | Universal Integrated Circuit Card |
| UIH | Unnumbered Information with header Check |
| URC | Unsolicited Result Code |
| USIM | UMTS Subscriber Identity Module |
| UTRAN | Universal Terrestrial Radio Access Network |
| UUS1 | User-to-User Signalling Supplementary Service 1 |
| WLAN | Wireless Local Area Network |

Related documentation

1. TOBY-L4 series data sheet, [UBX-16009856](#)
2. TOBY-L4 series system integration manual, [UBX-16024839](#)
3. TOBY-L2 series data sheet, [UBX-13004573](#)
4. MPCPI-L2 series data sheet, [UBX-13004749](#)
5. TOBY-L2 / MPCPI-L2 series system integration manual, [UBX-13004618](#)
6. LARA-R2 series data sheet, [UBX-16005783](#)
7. LARA-R2 series system integration manual, [UBX-16010573](#)
8. TOBY-R2 series data sheet, [UBX-16005785](#)
9. TOBY-R2 series system integration manual, [UBX-16010572](#)
10. SARA-R5 series data sheet, [UBX-19016638](#)
11. SARA-R5 series system integration manual, [UBX-19041356](#)
12. SARA-R5 series application development guide, [UBX-20009652](#)
13. SARA-R5 series Internet applications development guide, [UBX-20032566](#)
14. SARA-R4 series data sheet, [UBX-16024152](#)
15. SARA-R4 series system integration manual, [UBX-16029218](#)
16. SARA-R4 series application development guide, [UBX-18019856](#)
17. SARA-R42 application development guide, [UBX-20050829](#)
18. SARA-U2 series data sheet, [UBX-13005287](#)
19. LISA-U2 series data sheet, [UBX-13001734](#)
20. LISA-U1 series data sheet, [UBX-13002048](#)
21. LISA-U1 / LISA-U2 series system integration manual, [UBX-13001118](#)
22. SARA-G450 data sheet, [UBX-18006165](#)
23. SARA-G450 system integration manual, [UBX-18046432](#)
24. SARA-G3 series data sheet, [UBX-13000993](#)
25. SARA-G3 / SARA-U2 series system integration manual, [UBX-13000995](#)
26. LEON-G1 series data sheet, [UBX-13004887](#)
27. LEON-G1 series system integration manual, [UBX-13004888](#)
28. SARA-N2 series data sheet, [UBX-15025564](#)
29. NB-IoT application development guide, [UBX-16017368](#)
30. SARA-N3 series data sheet, [UBX-18066692](#)
31. SARA-N2 / SARA-N3 series system integration manual, [UBX-17005143](#)
32. SARA-N3 series application development guide, [UBX-19026709](#)
33. TOBY-R2 / LARA-R2 "O3B" audio application note, [UBX-20036864](#)
34. AT commands examples application note, [UBX-13001820](#)
35. u-blox multiplexer implementation application note, [UBX-13001887](#)
36. u-blox firmware update application note, [UBX-13001845](#)
37. GNSS implementation application note, [UBX-13001849](#)
38. End user test application note, [UBX-13001922](#)
39. Wi-Fi / cellular integration application note, [UBX-14003264](#)
40. LTE initial default bearer application note, [UBX-20015573](#)
41. eCall / ERA GLONASS Implementation in u-blox cellular modules, [UBX-13001924](#)
42. TOBY-L4 series extended audio application note, [UBX-17065359](#)
43. TOBY-L4 uCPU series Audio CSD API application note, [UBX-18067601](#)
44. TOBY-L4 series eCall implementation in u-blox cellular modules application note, [UBX-18019819](#)
45. TOBY-L2 series audio application note, [UBX-15015834](#)
46. TOBY-L2 series networking modes application note, [UBX-14000479](#)
47. TOBY-L2 / MPCPI-L2 series enforced security application note, [UBX-19022699](#)
48. SARA-U2 audio application note, [UBX-14002981](#)
49. SARA-U2 series audio extended tuning application note, [UBX-17012797](#)
50. LISA-U1 / LISA-U2 audio application note, [UBX-13001835](#)
51. SARA-G3 audio application note, [UBX-13001793](#)

52. LEON-G1 audio application note, [UBX-13001890](#)
53. SARA-R5 series firmware update with uFOTA, FOAT and EasyFlash application note, [UBX-20033314](#)
54. SARA-R4 / SARA-R5 series positioning implementation application note, [UBX-20012413](#)
55. SARA-R4 series firmware update with uFOTA, FOAT and EasyFlash application note, [UBX-17049154](#)
56. LwM2M objects and commands application note, [UBX-18068860](#)
57. IoT Security-as-a-Service application note, [UBX-20013561](#)
58. 3GPP TS 27.007 - Technical Specification Group Core Network and Terminals; AT command set for User Equipment (UE)
59. 3GPP TS 22.004 - General on supplementary services
60. 3GPP TS 22.030 - Digital cellular telecommunications system (Phase 2+); Universal Mobile Telecommunications System (UMTS); Man-Machine Interface (MMI) of the User Equipment (UE)
61. 3GPP TS 22.090 - Unstructured Supplementary Service Data (USSD); Stage 1
62. 3GPP TS 23.038 - Alphabets and language-specific information
63. 3GPP TS 23.040 - Technical realization of Short Message Service (SMS)
64. 3GPP TS 23.041 - Technical realization of Cell Broadcast Service (CBS)
65. 3GPP TS 23.060 - Technical Specification Group Services and System Aspects; General Packet Radio Service (GPRS); Service description
66. 3GPP TS 24.007 - Mobile radio interface signalling layer 3; General aspects
67. 3GPP TS 24.008 - Mobile radio interface layer 3 specification
68. 3GPP TS 24.011 - Point-to-point (PP) Short Message Service (SMS) support on mobile radio interface
69. 3GPP TS 27.005 - Technical Specification Group Terminals; Use of Data Terminal Equipment - Data Circuit terminating Equipment (DTE-DCE) interface for Short Message Services (SMS) and Cell Broadcast Service (CBS)
70. 3GPP TS 27.060 - Technical Specification Group Core Network; Packet Domain; Mobile Station (MS) supporting Packet Switched Services
71. 3GPP TS 51.011 - Digital cellular telecommunications system (Phase 2+); Specification of the Subscriber Identity Module - Mobile Equipment (SIM - ME) interface
72. 3GPP TS 31.102 - Characteristics of the Universal Subscriber Identity Module (USIM) application
73. 3GPP TS 05.08 - Radio subsystem link control
74. 3GPP TS 22.087 - User-to-User Signalling (UUS)
75. 3GPP TS 22.022 - Personalisation of Mobile Equipment (ME)
76. 3GPP TS 22.082 - Call Forwarding (CF) supplementary services
77. 3GPP TS 22.083 - Call Waiting (CW) and Call Holding (HOLD)
78. 3GPP TS 22.081 - Line identification Supplementary Services- Stage 1
79. 3GPP TS 23.081 - Line identification supplementary services- Stage 2
80. 3GPP TS 22.086 - Advice of Charge (AoC) Supplementary Services
81. 3GPP TS 22.024 - Description of Charge Advice Information (CAI)
82. 3GPP TS 22.085 - Closed User Group (CUG) Supplementary Services
83. 3GPP TS 22.096 - Name identification supplementary services
84. 3GPP TS 04.18 - Mobile radio interface layer 3 specification; Radio Resource Control (RRC) protocol
85. 3GPP TS 05.02 - Multiplexing and Multiple Access on the Radio Path
86. 3GPP TS 51.014 - Specification of the SIM Application Toolkit for the Subscriber Identity Module - Mobile Equipment (SIM - ME) interface
87. 3GPP TS 27.010 V3.4.0 - Terminal Equipment to User Equipment (TE-UE) multiplexer protocol (Release 1999)
88. 3GPP TS 22.060 - General Packet Radio Service (GPRS); Service description; Stage 1
89. 3GPP TS 25.306 - UE Radio Access capabilities
90. 3GPP TS 22.002 - Circuit Bearer Services (BS) supported by a Public Land Mobile Network (PLMN)
91. 3GPP TS 22.067 - enhanced Multi Level Precedence and Pre-emption service (eMLPP); Stage 1
92. 3GPP TS 23.972 - Circuit switched multimedia telephony
93. 3GPP TS 24.615 Communication Waiting (CW) using IP Multimedia (IM) Core Network (CN) subsystem; Protocol Specification
94. 3GPP TS 25.101 - User Equipment (UE) radio transmission and reception (FDD)
95. 3GPP TS 23.122 - NAS Functions related to Mobile Station (MS) in idle mode

96. 3GPP TS 45.005 - Radio transmission and reception
97. 3GPP TS 23.014 Support of Dual Tone Multi-Frequency (DTMF) signalling V11.0.0 (2012-09)
98. 3GPP TS 26.267 V12.0.0 (2012-12) eCall Data Transfer; In-band modem solution; General description (Release 12)
99. 3GPP TS 51.010-1 Mobile Station (MS) conformance specification; Part 1: Conformance specification
100. 3GPP TS 51.010-2 Mobile Station (MS) conformance specification; Part 2: Protocol Implementation Conformance Statement (PICS) proforma specification
101. 3GPP TS 34.121-2 User Equipment (UE) conformance specification; Radio transmission and reception (FDD); Part 2: Implementation Conformance Statement (ICS)
102. 3GPP TS 24.301 Non-Access-Stratum (NAS) protocol for Evolved Packet System (EPS); Stage 3
103. 3GPP TS 44.060 General Packet Radio Service (GPRS); Mobile Station (MS) - Base Station System (BSS) interface; Radio Link Control / Medium Access Control (RLC/MAC) protocol
104. 3GPP TS 23.221 Architectural requirements
105. 3GPP TS 23.203 Policy and charging control architecture
106. 3GPP TS 31.101 UICC-terminal interface; Physical and logical characteristics
107. 3GPP TS 25.305 User Equipment (UE) positioning in Universal Terrestrial Radio Access Network (UTRAN); Stage 2
108. 3GPP TS 23.032: Universal Geographical Area Description (GAD)
109. 3GPP TS 25.331 Radio Resource Control (RRC); Protocol specification
110. 3GPP TS 36.101 Evolved Universal Terrestrial Radio Access (E-UTRA); User Equipment (UE) radio transmission and reception
111. 3GPP TS 24.173 IMS Multimedia telephony communication service and supplementary services; Stage 3
112. 3GPP TS 24.341 Support of SMS over IP networks; Stage 3
113. 3GPP TS 24.229 IP multimedia call control protocol based on Session Initiation Protocol (SIP) and Session Description Protocol (SDP); Stage 3
114. 3GPP TS 36.306 Evolved Universal Terrestrial Radio Access (E-UTRA); User Equipment (UE) radio access capabilities
115. 3GPP TS 36.133 Evolved Universal Terrestrial Radio Access (E-UTRA); Requirements for support of radio resource management
116. 3GPP TS 25.133 Requirements for support of radio resource management (FDD)
117. 3GPP TS 22.071 Location Services (LCS); Service description
118. 3GPP TS 36.331 Evolved Universal Terrestrial Radio Access (E-UTRA); Radio Resource Control (RRC); Protocol specification (Release 10)
119. 3GPP TS 24.167 3GPP IMS Management Object (MO); Stage 3
120. 3GPP TS 26.201 Speech codec speech processing functions; Adaptive Multi-Rate - Wideband (AMR-WB) speech codec; Frame structure
121. 3GPP TS 24.216 Communication Continuity Management Object (MO)
122. 3GPP TS 36.521-2 - Evolved Universal Terrestrial Radio Access (E-UTRA); User Equipment conformance specification; Radio transmission and reception; Part 2: Implementation Conformance Statement (ICS)
123. 3GPP TS 36.523-2 - Evolved Universal Terrestrial Radio Access (E-UTRA) and Evolved Packet Core (EPC); User Equipment conformance specification; Part 2: Implementation Conformance Statement (ICS)
124. 3GPP TS 23.003 Numbering, addressing and identification
125. 3GPP TS 31.111 Universal Subscriber Identity Module (USIM) Application Toolkit (USAT)
126. 3GPP TS 22.084 MultiParty (MPTY) supplementary service; Stage 1
127. 3GPP TS 24.607 Originating Identification Presentation (OIP) and Originating Identification Restriction (OIR) using IP Multimedia (IM) Core Network (CN) subsystem; Protocol specification
128. 3GPP TS 24.608 Terminating Identification Presentation (TIP) and Terminating Identification Restriction (TIR) using IP Multimedia (IM) Core Network (CN) subsystem; Protocol specification
129. 3GPP TS 36.213 Evolved Universal Terrestrial Radio Access (E-UTRA); Physical layer procedures
130. 3GPP TS 36.212 Evolved Universal Terrestrial Radio Access (E-UTRA); Multiplexing and channel coding
131. 3GPP TS 24.166 - 3GPP IP Multimedia Subsystem (IMS) conferencing Management Object (MO)
132. 3GPP TS 29.061 - Interworking between the Public Land Mobile Network (PLMN) supporting packet based services and Packet Data Networks (PDN)
133. 3GPP TS 24.303 - Mobility management based on Dual-Stack Mobile IPv6; Stage 3

- 134. 3GPP TS 24.327 - Mobility between 3GPP Wireless Local Area Network (WLAN) interworking (I-WLAN) and 3GPP systems; General Packet Radio System (GPRS) and 3GPP I-WLAN aspects; Stage 3
- 135. 3GPP TS 25.367 - Mobility procedures for Home Node B (HNB); Overall description; Stage 2
- 136. 3GPP TS 25.304 - User Equipment (UE) procedures in idle mode and procedures for cell reselection in connected mode
- 137. 3GPP TS 36.304 - Evolved Universal Terrestrial Radio Access (E-UTRA); User Equipment (UE) procedures in idle mode
- 138. 3GPP TS 45.008 - GSM/EDGE Radio Access Network; Radio subsystem link control
- 139. 3GPP TS 25.401 - Universal Mobile Telecommunications System (UMTS); UTRAN Overall Description
- 140. 3GPP TS 24.237 - Technical Specification Group Core Network and Terminals; IP Multimedia (IM) Core Network (CN) subsystem IP Multimedia Subsystem (IMS) Service Continuity; Stage 3
- 141. 3GPP TS 36.211 - Evolved Universal Terrestrial Radio Access (E-UTRA); Physical channels and modulation
- 142. 3GPP TS 23.682 - Architecture enhancements to facilitate communications with packet data networks and applications
- 143. 3GPP TS 23.401 - General Packet Radio Service (GPRS) enhancements for Evolved Universal Terrestrial Radio Access Network (E-UTRAN) access
- 144. 3GPP TS 44.018 - Mobile radio interface layer 3 specification; GSM/EDGE Radio Resource Control (RRC) protocol
- 145. 3GPP TS 43.064 - General Packet Radio Service (GPRS); Overall description of the GPRS radio interface; Stage 2
- 146. 3GPP TS 36.321 - Evolved Universal Terrestrial Radio Access (E-UTRA); Medium Access Control (MAC) protocol specification
- 147. 3GPP TS 22.011 - Service accessibility
- 148. 3GPP2 C.S0015-0 - Short Message Service
- 149. ETSI TS 102 223 - Smart cards; Card Application Toolkit (CAT)
- 150. ETSI TS 102 221 V8.2.0 (2009-06) Smart Cards; UICC-Terminal interface; Physical and logical characteristics (Release 8)
- 151. ETSI TS 127 007 V10.3.0 (2011-04) AT command set for User Equipment (UE) (3GPP TS 27.007 version 10.3.0 Release 10)
- 152. ETSI TS 122 101 V8.7.0 (2008-01) Service aspects; Service principles (3GPP TS 22.101 version 8.7.0 Release 8)
- 153. GSM 02.04 - Digital cellular telecommunications system (Phase 2+); Mobile Stations (MS) features
- 154. GSM 03.60 - Digital cellular telecommunications system (Phase 2+); General Packet Radio Service (GPRS) Service description; Stage 2
- 155. GSM 04.12 - Digital cellular telecommunications system (Phase 2+); Short Message Service Cell Broadcast (SMSCB) Support on Mobile Radio Interface.
- 156. GSM 04.60 - Digital cellular telecommunications system (Phase 2+); General Packet Radio Service (GPRS); Mobile Station (MS) - Base Station System (BSS) interface; Radio Link Control / Medium Access Control (RLC/MAC) protocol
- 157. GSMA TS.34 - IoT Device Connection Efficiency Guidelines
- 158. RFC 791 - Internet Protocol - <http://www.ietf.org/rfc/rfc791.txt>
- 159. RFC 2460 - Internet Protocol, Version 6 (IPv6) - <http://www.ietf.org/rfc/rfc2460.txt>
- 160. RFC 3267 - Real-Time Transport Protocol (RTP) Payload Format and File Storage Format for the Adaptive Multi-Rate (AMR) and Adaptive Multi-Rate Wideband (AMR-WB) Audio Codecs
- 161. RFC 792 Internet Control Message Protocol (<http://tools.ietf.org/html/rfc0792>)
- 162. RFC 959 File Transfer Protocol (<http://tools.ietf.org/html/rfc959>)
- 163. RFC 2428 FTP Extensions for IPv6 and NATs (<https://tools.ietf.org/html/rfc2428>)
- 164. RFC 4291 - IP Version 6 Addressing Architecture (<http://tools.ietf.org/html/rfc4291>)
- 165. RFC 793 - Transmission Control Protocol (TCP) Protocol Specification (<https://www.rfc-editor.org/rfc/rfc793.txt>)
- 166. RFC 3969 - The Internet Assigned Number Authority (IANA) Uniform Resource Identifier (URI) Parameter Registry for the Session Initiation Protocol (SIP)
- 167. RFC 3261 - SIP: Session Initiation Protocol
- 168. RFC 5341 - The Internet Assigned Number Authority (IANA) tel Uniform Resource Identifier (URI) Parameter Registry

- 169. RFC 3966 - The tel URI for Telephone Numbers
- 170. RFC 2141 - URN Syntax
- 171. RFC 3406 - Uniform Resource Names (URN) Namespace Definition Mechanisms
- 172. RFC 5031 - A Uniform Resource Name (URN) for Emergency and Other Well-Known Services
- 173. RFC 4715 - The Integrated Services Digital Network (ISDN) Subaddress Encoding Type for tel URI
- 174. RFC 5626 - Managing Client-Initiated Connections in the Session Initiation Protocol (SIP)
- 175. RFC 4867 - RTP Payload Format and File Storage Format for the Adaptive Multi-Rate (AMR) and Adaptive Multi-Rate Wideband (AMR-WB) Audio Codecs
- 176. RFC 4733 - RTP Payload for DTMF Digits, Telephony Tones, and Telephony Signals
- 177. RFC 1518 - An Architecture for IP Address Allocation with CIDR (<https://tools.ietf.org/html/rfc1518>)
- 178. RFC 1519 - Classless Inter-Domain Routing (CIDR): an Address Assignment and Aggregation Strategy (<https://tools.ietf.org/html/rfc1519>)
- 179. RFC 7252 - Constrained Application Protocol (CoAP)
- 180. RFC 8323 - CoAP (Constrained Application Protocol) over TCP, TLS, and WebSockets - <https://www.ietf.org/rfc/rfc8323.txt>
- 181. RFC 5280 - Internet X.509 Public Key Infrastructure Certificate and Certificate Revocation List (CRL) Profile - <http://www.ietf.org/rfc/rfc5280.txt>
- 182. RFC 7925 - TLS/DTLS IoT Profiles - <https://www.ietf.org/rfc/rfc7925.txt>
- 183. RFC 7959 - Block-Wise Transfers in the Constrained Application Protocol (CoAP) - <https://www.ietf.org/rfc/rfc7959.txt>
- 184. ITU-T Recommendation V250, 05-99.
- 185. ITU-T V.25ter - ITU-T V.25 ter Recommendation: Data Communications over the Telephone Network; Serial asynchronous automatic Dialling and control.
- 186. ITU-T T.32 - ITU-T Recommendation T.32 Asynchronous Facsimile DCE Control - Service Class 2
- 187. ISO 639 (1988) Code for the representation of names of languages
- 188. ITU-T Recommendation V24, 02-2000. List of definitions for interchange circuits between Data Terminal Equipment (DTE) and Data Connection Equipment (DCE).
- 189. ITU-T E.212 - Series E: Overall network operation, telephone service, service operation and human factors
- 190. IEC 61162 Digital interfaces for navigational equipment within a ship
- 191. Stevens. TCP/IP Illustrated Volume1 & 2 Addison-Wesley, 1994.
- 192. SIM Access Profile - Interoperability Specification - Bluetooth Specification V11r00
- 193. Device terminal access protocol-EDP technical specification, version 1.6
- 194. BS EN 16062:2015 Intelligent transport systems - ESafety - eCall high level application requirements (HLAP) using GSM/UMTS circuit switched networks, April 2015
- 195. PCCA standard - Command set extensions for CDPD modems, Revision 2.0, March, 1998
- 196. OMA Device Management V1.2.1 (<http://technical.openmobilealliance.org/Technical/technical-information/release-program/current-releases/dm-v1-2-1>)
- 197. Open Mobile Alliance (OMA) SyncML Common Specification, Version 1.2.2 (<http://www.openmobilealliance.org/release/Common>)
- 198. Open Mobile Alliance (OMA) - Lightweight Machine to Machine Technical Specification, Version 1.0
- 199. MQTT Version 3.1.1 - OASIS Standard
- 200. MQTT-SN Protocol Specification Version 1.2
- 201. AT&T: Device Requirements -- Requirements Document -- Document Number 13340 -- Revision 4.6 -- Revision Date 9/2/11
- 202. Common PCN Handset Specification v4.2
- 203. Maxim MAX9860 16-Bit Mono Audio Voice Codec datasheet, 19-4349; Rev 1; 9/09. Available from the Maxim website (<http://datasheets.maxim-ic.com/en/ds/MAX9860.pdf>)
- 204. Digital Communication Standard -Ademco Contact ID Protocol -for Alarm System Communications,SIA DC-05-1999.09



For regular updates to u-blox documentation and to receive product change notifications, register on our homepage.

Revision history

| Revision | Date | Name | Comments |
|----------|-------------|------|--|
| R01 | 27-Jan-2017 | jole | Initial release |
| R02 | 03-Apr-2017 | jole | Removed +UPSV. Added +CPSMS . General document clean-up |
| R03 | 04-May-2017 | jole | Added SARA-R410M |
| R04 | 24-May-2017 | jole | Moved to Advance Information for SARA-R404M |
| R05 | 19-Jul-2017 | jole | Extended document applicability to SARA-R410M-02B. Added +ULWM2M , +ULWM2MSTAT and +CNUM . Changed +CPSMS back to it's original 3GPP definition. Added FOAT file tag. |
| R06 | 30-Oct-2017 | jole | Extended document applicability to SARA-R412M-02B. Added DTR and PPP behavior clarification. Updated max response time for +USOCL . New commands: +UCPSMS , +CCLK , +CTZU , +CEDRXS , +CEDRXRDP , +USECMNG , +USECPRF , +USOSEC and O . |
| R07 | 09-Feb-2018 | jole | New commands: +CSCS , +UCGED , +PACSP , +UMNOPROF , +UBANDMASK , +UCMGR , +UCMGL , +UCMGS , +UCMGW , +USIMSTAT , +CSIM , +CLAN , +UBIP , +CUSATR , +CUSATW , +UCUSATA , +CEMODE , +UDCONF=75 , +UDCONF=76 , +UDWNBLOCK , +URDBLOCK , +USOCLCFG , +UGPS , +UGAOS , +UGSRV , +UGIND , +UGPRF , +UGUBX , +UGTMR , +UGZDA , +UGGGA , +UGGLL , +UGGSV , +UGRMC , +UGVTG , +UGGSA , +ULOC , +ULOCIND , +ULOCGNSS , +UI2CO , +UI2CW , +UI2CR , +UI2CREGR , +UI2CC . Modified commands: +CMUX , D , +COPS , +URAT , +CEDRXS , +CEDRXRDP , &D , S2 , +IPR , D* , +CEREG , +CGACT , +CPSMS , +UCPSMS , GPIO introduction , File System Introduction , +USODL , +USOCTL , +USECMNG , +USECPRF , AT commands. Updated estimated response time information for these commands: +USOCL , +USOCO , +USOWR . |
| R08 | 27-Apr-2018 | jole | New commands: +CREG , +UMNOPROF , +UPSD , +CGEREP , +CGREG , +UMQTT , +UMQTTWTOPIC , +UMQTTWMSG , +UMQTTNV , +UMQTTTC , +UMQTTTER . Modified commands: +COPS , \Q , +CGDCONT , +CEMODE , +UAUTHREQ , +UTEST , File System Introduction , Internet protocol transport layer , +USOGO , +USOCL , +USOCLCFG , +USOSEC , +USOCO , Internal TCP/UDP/IP stack class error codes . Updated estimated response time information for these commands: +USOCL , +USOCO , +USOST , +USOSEC . |
| R09 | 15-Jun-2018 | jole | Extended the document applicability to SARA-R410M-52B and SARA-N410-02B. New commands: +CSGT , +CRTDCP , +CSODCP , +UPSV , +UFOTACONF , +ULGASP , +UTEMP , +UDNSRN . Modified commands: +CMUX , +CFUN , +CSQ , +COPS , +UCGED , +UMNOPROF , <PDP_Type> , +CEREG , +UDCONF=76 , +UFWINSTALL , +UTEST , +CPSMS , GPIO introduction , +USODL , SSL/TLS introduction , +USECMNG , +USECPRF , +UHTTP . |
| R10 | 03-Aug-2018 | jole | New commands: +UHOSTDEV , +URINGCFG . Modified commands: +URAT , +UBANDMASK , +CEDRXS , +CPMS , &K , +IFC , +USIMSTAT , +UCUSATA , +CUSATR , +CUSATW , +UTEST , +UTEMP , +UFOTACONF , GPIO introduction , +USOSO , +USOCTL , +UDCONF=5 , +UI2CR , +UMQTT , +UMQTTTC . Review the command applicability for these commands: &K , +IFC . |
| R11 | 01-Dec-2018 | lpah | Extended the document applicability to SARA-R404M-00B-01. |
| R12 | 20-Feb-2019 | lpah | New commands: +CSCON , +USVCDOMAIN , +CGPIAF , +CGCONTRDP , +UPSMR . Modified commands: I , +CSCS , +CFUN , +CSQ , +COPS , +URAT , +CREG , +CEDRXS , +UMNOPROF , +CNMI , +CSODCP , +IPR , Primary and secondary PDP contexts , <PDP_Type> , +CEREG , +UDCONF=76 , +UTEST , +ULWM2MSTAT , +UFOTACONF , +URINGCFG , Network status indication , |

| Revision | Date | Name | Comments |
|----------|-------------|------|---|
| | | | <p>+USOWR, +USORD, +USORF, +USECMNG, AT+USECMNG command example, +UHTTP, +ULOC, +UMQTT, +UMQTTC, +UMQTTER.</p> <p>Updated estimated response time information for these commands: +UFWUPD.</p> <p>Review the command applicability for these commands: +CSGT, +CTZU, +CEDRXS, +CEDRXRDP, +UCMGS, +CSODCP, +CRTDCP, +CRSM, +UPSV, +UTEMP, +ULGASP, +UFOTACONF, +URINGCFG, +UDNSRN, +UGPS, +UGIND, +UGPRF, +UGSRV, +UGAOS, +UGUBX, +UGTMR, +UGZDA, +UGGGA, +UGLL, +UGGSV, +UGRMC, +UGVTG, +UGGSA, +ULOC, +ULOCIND, +ULOCNSS, +UDCONF=8.</p> |
| R13 | 24-Jun-2019 | lpah | <p>Extended the document applicability to SARA-R410M-02B-01, SARA-R410M-52B-01, SARA-R412M-02B-01.</p> <p>Modified commands: Information text responses and result codes, General Operations, +CMUX, +CFUN, +CSGT, +CTZU, D, +COPS, +URAT, +CREG, +PACSP, +UCGED, +CSCON, +CEDRXS, +UMNOPROF, +UBANDMASK, +USVCDOMAIN, +CMGF, +CNMI, +CMGD, +CSODCP, +CRTDCP, &C, &D, &K, &S, +ICF, +IFC, \Q, +IPR, S2, S3, S4, S5, S6, S7, S8, S10, S12, E, V, X, Z, &F, &V, +UBIP, +CUSATW, <PDP_Type>, +CGPIAF, +CGREG, H, +CEMODE, +CEREG, +UAUTHREQ, +UDCONF=76, +UPSV, +UTEST, +UTEMP, +CPSMS, +UCPSMS, +UFOTACONF, +ULGASP, +URINGCFG, +UPSMR, GPIO Introduction, +UGPIOC, +UDWNFILE, +URDFILE, +UDWNBLOCK, +UDNSRN, +USODL, +USOCTL, +USECPRF, +UFTPC, +UHTTP, +UHTTPC, +UGPRF, +UMQTT, +UMQTTC, +UMQTTER, Internet suite error classes, Multiple AT command interfaces.</p> <p>Updated estimated response time information for these commands: +UMQTTC.</p> <p>Review the command applicability for these commands: S0, +USVCDOMAIN, +CSGT, +CSCON, +CSODCP, +CRTDCP, &K, +IFC, +CUSATW, +UPSV, +UTEMP, +UFOTACONF, +ULGASP, +URINGCFG, +UPSMR, +UDNSRN.</p> |
| R14 | 11-Sep-2019 | lpah | <p>Extended document applicability to SARA-R410M-63B / SARA-R410M-73B.</p> <p>New commands: +CSCON, +UBANDMASK, +CIPCA, +UFOTA, +UFOTASTAT, +UDCONF=10, +USECCHIP, +USECROTUID, +USECDEVINFO, +USECOFF, +USECDATAENC, +USECFILEENC, +USECDATADEC, +USECFILEDEC, +USECE2EDATAENC, +USECE2EFILEENC, +USECPSK, +ULWM2MADD, +ULWM2MREMOVE, +ULWM2MLIST, +ULWM2MCREATE, +ULWM2MDELETE, +ULWM2MWRITE, +ULWM2MREAD, +ULWM2MREG, +ULWM2MDEREG, +ULWM2MPULSE.</p> <p>Modified commands: AT Command Settings, +CMUX, I, +CFUN, +COPS, +URAT, +CREG, +UCGED, +CEDRXS, +UMNOPROF, +UBANDMASK, +CCIOPT, +IPR, O, &V, +UBIP, +CUSATW, +UPSD, D*, +CGREG, +CEMODE, +CEREG, +UAUTHREQ, +CIPCA, +UFWINSTALL, +UFOTACONF, GPIO Introduction, +UGPIOC, File System Introduction, +UDWNFILE, +USECMNG, +USECPRF, +USODL, +UDCONF=5, +UDCONF=6, +UFTPC, +UHTTPC, +UGPRF, +ULOC, +UMQTTC, +ULWM2MSTAT, +ULWM2M, Mobile termination error result codes +CME ERROR, Internal TCP/UDP/IP stack class error codes.</p> <p>Review the command applicability for these commands: +CSCON.</p> |
| R15 | 20-Dec-2019 | lpah | <p>New commands: +CPAS, +ULWM2MNOTIFY, +ULWM2MCONFIG.</p> <p>Modified commands: Switch from data mode to online command mode, Information text responses and result codes, +CSCS, +CGMM, +CGMR, +GMM, +GMR, I, +CPWROFF, +CFUN, D, A, <Requested_eDRX_cycle>, <Assigned_eDRX_cycle>, <Requested_paging_time_window>, <Assigned_paging_time_window>, +COPS, +URAT, +UCGED, +CEDRXS, +CEDRXRDP, +UMNOPROF, +UBANDMASK, +CSCON, +CLCK, SMS introduction, +CSDH, +CNMI, +IFC, S2, S12, +UBIP, <APN>, +CGDCONT, +CGATT, +CEMODE, +CEREG, +CGCONTRDP, +CPSMS, +UCPSMS, +UPSMR, +USOCR, +USECDEVINFO, +USECMNG, +USECPRF, +USECDATADEC, +UMQTT, +UMQTTWTOPIC, +UMQTTWMSG,</p> |

| Revision | Date | Name | Comments |
|----------|-------------|------|---|
| | | | <p>+UMQTTT, +UMQTTT, LwM2M objects management, +ULWM2MADD, +ULWM2MREMOVE, +ULWM2MLIST, +ULWM2MCREATE, LwM2M connectivity, +ULWM2MPULSE, SARA-R410M-02B Americas MNO profiles, SARA-R410M-52B Americas MNO profiles.</p> <p>Review the command applicability for these commands: H, +CSDH, &K, +UPSMR.</p> |
| R16 | 11-Jun-2020 | lpah | <p>Extended the document applicability to SARA-R410M-83B.</p> <p>New commands: +UBKUPDATA, +USECCONN, +ULOCALID, +ULOCCELL, +ODIS.</p> <p>Modified commands: AT command settings, Switch from data mode to online command mode, AT Commands Settings Notes, Information text responses and result codes, +CMUX, +CGSN, +CSCS, +CPWROFF, <MCC>, <MNC>, +CSQ, +COPS, +URAT, +CREG, +UCGED, +CEDRXS, +CEDRXRDP, +UMNOPROF, +UBANDMASK, +VZWAPNE, +VZWRSP, +VZWRSP, +USVCDOMAIN, +CCIOTOPT, SMS introduction, +CMGF, +CSDH, +CNMI, +CNMA, +CMGL, \Q, +IPR, S6, S7, S8, +CLAN, +USIMSTAT, +UBIP, +CUSATW, Primary and secondary PDP contexts, Multiple PDP contexts, +CGDCONT, +UPSD, +CGREG, +CEMODE, +CEREG, +CIPCA, +UFOTA, +UTEST, +UFOTASTAT, +UFOTACONF, +CPSMS, +UPSMR, GPIO introduction, Module status indication, Module operating mode indication, File tags, +UDWNFILE, +USOSEC, +USOCTL, Device security introduction, Data security introduction, +USECMNG, +USECPRF, +UFTP, +UHHTPC, +UGPRF, +UGUBX, +ULOC, +UMQTT, +UMQTTWTOPIC, +UMQTTWMSG, +UMQTTT, +UMQTTT, +ULWM2MADD, +ULWM2MREMOVE, +ULWM2MLIST, +ULWM2MCREATE, +ULWM2MDELETE, +ULWM2MWRITE, +ULWM2MREAD, LwM2M connectivity, +ULWM2MSTAT, +ULWM2M, +ULWM2MREG, +ULWM2MDEREG, +ULWM2MCONFIG, +ULWM2MPULSE, +ULWM2MNOTIFY, SARA-R4 "x3" APAC MNO profiles, SARA-R4 "x3" Americas MNO profiles, SARA-R4 "x3" EMEA MNO profiles, SARA-R412M-02B Americas MNO profiles.</p> <p>Review the command applicability for these commands: +VZWAPNE, +VZWRSP, +VZWRSP, +UFOTA, +UFOTASTAT, +ULWM2MADD, +ULWM2MREMOVE, +ULWM2MLIST, +ULWM2MCREATE, +ULWM2MDELETE, +ULWM2MWRITE, +ULWM2MREAD, +ULWM2MREG, +ULWM2MDEREG, +ULWM2MCONFIG, +ULWM2MNOTIFY, +ULWM2MPULSE.</p> |
| R17 | 31-Aug-2020 | lpah | <p>Extended the document applicability to SARA-R410M-02B-02, SARA-R410M-52B-02, SARA-R412M-02B-02.</p> <p>New commands: +CTZR, +COPN, +URATSCAN.</p> <p>Modified commands: AT Commands Settings Notes, +CFUN, +COPS, +CREG, +UCGED, +CEDRXS, +UMNOPROF, +CCIOTOPT, +USVCDOMAIN, +UDCONF=77, +CSMS, &C, &D, &S, &K, +ICF, +IPR, S3, S4, S5, S6, S7, E, Q, V, X, SIM toolkit introduction, Multiple PDP contexts, <PDP_Type>, +CGDCONT, +UPSD, D*, +CGREG, +CEREG, +UAUTHREQ, +UFWUPD, +UTEST, +UBKUPDATA, +UFOTA, +UFOTASTAT, +UFOTACONF, +UPSV, +CPSMS, +UCPSMS, GPIO Introduction, File System Introduction, +UPSMR, +USOCR, +USORF, +USECOFF, +USECPRF, +UFTP, +UHHTPC, +UGPRF, +ULOC, +ULOCALID, +ULOCCELL, +UI2CO, +UI2CREGR, +UMQTT, +UMQTTWMSG, +UMQTTNV, +UMQTTT, +ULWM2MADD, +ULWM2MREMOVE, +ULWM2MLIST, +ULWM2MCREATE, +ULWM2MDELETE, +ULWM2MWRITE, +ULWM2MREAD, LwM2M connectivity, +ULWM2MSTAT, +ULWM2M, +ULWM2MREG, +ULWM2MDEREG, +ULWM2MCONFIG, +ULWM2MPULSE, +ULWM2MNOTIFY, +ODIS, Parameters stored in profiles, SARA-R410 M-02B Americas MNO profiles, SARA-R410M-02B APAC MNO profiles, SARA-R410M-02B EMEA MNO profiles, SARA-R410M-52B Americas MNO profiles, SARA-R4 "x3" APAC MNO profiles, SARA-R4 "x3" EMEA MNO profiles, SARA-R412M-02B Americas MNO profiles, SARA-R412M-02B EMEA MNO profiles.</p> <p>Review the command applicability for these commands: +UDCONF=77, &K.</p> |

| Revision | Date | Name | Comments |
|----------|-------------|------|--|
| R18 | 11-Nov-2020 | lpah | <p>Extended document applicability to SARA-R410M-73B-01 and SARA-R410M-83B-01.</p> <p>New commands: +USECMODE, +UDCONF=8.</p> <p>Modified commands: +CCLK, +UCGED, +CEDRXS, +UMNOPROF, +UTEST, +UFOTA, +UFOTASTAT, +ULGASP, +URINGCFG, +CPSMS, +UCPSMS, +UPSMR, GPIO introduction, +UGPIOC, Device security introduction, +USECOFF, +USOSEC, +USOCL, +USOWR, +USOST, +USODL, +UHTTP, Positioning introduction, +UGIND, +UGPRF, +UGAOS, +ULOC, +ULOCAID, +ULOCCELL, +ULWM2MCREATE, +ULWM2MREG, +ULWM2MWRITE, +ULWM2MCONFIG, +ULWM2MSTAT, SARA-R4 "x3" APAC MNO profiles, SARA-R4 "x3" Americas MNO profiles, SARA-R4 "x3" EMEA MNO profiles.</p> <p>Updated estimated response time information for these commands: +USOSEC, +USOST, +USOCO, +USOCL, +UDNSRN,</p> <p>Review the command applicability for these commands: +CSCON, +USECOFF.</p> |
| R19 | 09-Dec-2020 | lpah | <p>Modified commands: +CCLK, +UMNOPROF, +USVCDOMAIN, +CCIOPT, +CGDCONT, +UPSD, +CGACT, +UBKUPDATA, +ULWM2MREG, +ULWM2MDEREG, +ULWM2MCONFIG, SARA-R4 "x3" Americas MNO profiles, SARA-R4 "x3" APAC MNO profiles, SARA-R4 "x3" EMEA MNO profiles.</p> |
| R20 | 05-Mar-2021 | lpah | <p>Extended the document applicability to SARA-R410M-02B-03 and SARA-R412M-02B-03.</p> <p>New commands: +UMACQOSTMR.</p> <p>Modified commands: Storing of AT commands setting, Auto-registration, +CMUX, +CFUN, +CIND, +CMER, <Requested_eDRX_cycle>, <EARFCN>, <Requested_paging_time_window>, +URAT, +UCGED, +VZWRSPR, +VZWRSPRQ, +CEDRXS, +UMNOPROF, +UBANDMASK, +USVCDOMAIN, Multiple PDP contexts, +CGDCONT, +UPSD, +UTEST, +ULGASP, +UFOTACONF, +CPSMS, +UPSMR, File System Introduction, DNS introduction, TCP/IP UDP/IP Introduction, +USORD, +USORF, +USOST, +USODL, SSL/TLS introduction, +USECMNG, +USECPRF, Cipher suite applicability, FTP introduction, +UFTPC, HTTP introduction, +UHTTP, +UGPS, +UGIND, +UGPRF, +UGSRV, +UGUBX, +ULOC, +UMQTT, LwM2M connectivity, +ULWM2MSTAT, +ULWM2M, +ULWM2MCONFIG, +ODIS, SARA-R410M-02B Americas MNO profiles, SARA-R410M-02B APAC MNO profiles, SARA-R410M-02B EMEA MNO profiles, SARA-R4 "x3" Americas MNO profiles, SARA-R4 "x3" APAC MNO profiles, SARA-R410M-83B EMEA MNO profiles, SARA-R412M-02B Americas MNO profiles, SARA-R412M-02B EMEA MNO profiles.</p> <p>Updated estimated response time information for these commands: +USOST.</p> <p>Review the command applicability for these commands: +CSCON, +URATSCAN, +UFOTA, +UFOTASTAT, +UBKUPDATA, +UDCONF=8, +ULOCCELL, +ULOCAID, +ULWM2MADD, +ULWM2MREMOVE, +ULWM2MLIST, +ULWM2MDELETE, +ULWM2MCREATE, +ULWM2MWRITE, +ULWM2MREAD, +ULWM2MCONFIG, +ULWM2MREG, +ULWM2MDEREG, +ULWM2MPULSE, +ULWM2MNOTIFY, +ODIS.</p> |
| R21 | 19-Mar-2021 | lpah | <p>Extended document applicability to SARA-R422, SARA-R422S, SARA-R422M8S.</p> <p>New commands: H, +CVHU, +CPLS, +CPOL, +COPN, +UCFSCAN, +UMACQOSTMR, +UDCONF=81, +UDCONF=77, +CEINFO, +CMGC, +UARTCONF, +UPSMVER, +UDCONF=8, +USIO, +UDYNDNS, PING introduction, +UPING, +UIPCHGN.</p> <p>Modified commands: Storing of AT commands setting, Auto-registration, +CMUX, +CFUN, +CIND, +CMER, <Requested_eDRX_cycle>, <Requested_paging_time_window>, <RSRP_value>, <RSRQ_value>, +COPS, +CREG, +CPOL, +UCGED, +CEDRXS, +UMNOPROF, +UBANDMASK, +UCFGCIOT, +CCIOPT, SMS introduction, +CSDH, +CMSS, +UCMGL, +UCMGR, +UCMGS, +UCMGW, +CUAD, +CGDCONT, +UPSD, +CGREG, +CEREG,</p> |

| Revision | Date | Name | Comments |
|----------|-------------|------|--|
| | | | <p>+UAUTHREQ, +UANTR, +UTEST, +UFOTASTAT, +ULGASP, +URINGCFG, +UPSV, +CPSMS, +UCPSMS, +UPSMR, +UPSMVER, GPIO Introduction, +UGPIOC, File System Introduction, DNS introduction, TCP/IP UDP/IP Introduction, +USOST, +USORD, +USORF, +USODL, Data security introduction, +USECMNG, +USECPRF, Cipher suite applicability, FTP introduction, +UFTP, +UFTPC, HTTP introduction, +UHTTP, +UHTTTPC, Positioning introduction, +UGPS, +UGIND, +UGPRF, +UGSRV, +UGAOS, +UGUBX, +ULOC, +ULOCIND, +ULOCAID, +ULOCCELL, +UCOAP, +UCOAPC, +UMQTT, +UMQTTNV, +UMQTTT, +UMQTTTER, MQTT-SN introduction, +UMQTTSN, +UMQTTSNC, LwM2M connectivity, +ULWM2MSTAT, +ULWM2M, +ULWM2MREG, +ULWM2MDEREG, +ULWM2MCONFIG, Internet suite error classes, MQTT class error codes, MQTT-SN class error codes, SARA-R422 Americas MNO profiles, SARA-R422 EMEA MNO profiles.</p> <p>Review the command applicability for these commands: +VZWAPNE, +VZWSRP, +VZWSRQ, +CUAD, +UPSD, +UFOTA, +UFOTASTAT, +UDNSRN, +USOSEC, +USECCHIP, +USECROTUID, +USECDEVINFO, +USECMODE, +USECCONN, +USECDATAENC, +USECDATADEC, +USECFILEENC, +USECFILEDEC, +USECPSK, +USECE2EDATAENC, +USECE2EFILEENC, +UFTP, +UFTPC, +UFTPER, +UHTTP, +UHTTTPAC, +UHTTTPC, +UHTTTPER, +UGPS, +UGIND, +UGPRF, +UGUBX, +UGTMR, +UGZDA, +UGGGA, +UGGLL, +UGGSV, +UGRMC, +UGVTG, +UGGSA, +ULOC, +ULOCIND, +ULOCAID, +ULOCGNSS, +ULOCCELL, +UMQTTWTOPIC, +UMQTTWMSG, +ULWM2M, +ULWM2MDEREG, +ULWM2MCONFIG, +ULWM2MNOTIFY, +ODIS.</p> |
| R22 | 28-Jun-2021 | lpah | <p>New commands: +UDCONF=20, +URPM, +UDCONF=40, +UFACTORY, +UDCONF=18, +UEMBPF.</p> <p>Modified commands: AT commands settings, General operation, +CMUX, +CFUN, +CCLK, +COPS, +URAT, +UJAD, +UMACQOSTMR, +CPOL, +UCGED, +UCFSCAN, +USVCDOMAIN, +UBANDMASK, +CCIOPT, +CLCK, +CPMS, +CMGR, +CMGL, +UCMGR, +UCMGL, +UCMGP, &D, +IPR, +UPSD, +CGACT, +CEREG, +CIPCA, +UFWINSTALL, +UFWUPD, +USIO, +UFACTORY, +UBKUPDATA, +UFOTA, +ULGASP, +CPSMS, +UCPSMS, +UPSMVER, +UPSMR, GPIO Introduction, +UDWNFILE, TCP/IP UDP/IP Introduction, +USOGO, +USOCO, +USOST, +UDCONF=1, +USOCTL, +USECROTUID, +USECDEVINFO, +USECMODE, +USECCONN, +USECOPCMD, Data security introduction, +USECPRF, +USECPSK, +USECDATAENC, +USECFILEENC, +USECDATADEC, +USECFILEDEC, +USECE2EDATAENC, +USECE2EFILEENC, +UFTP, +UFTPC, +UHTTP, +UHTTTPC, +UPING, +ULOCCELL, +UCOAPC, MQTT introduction, +UMQTTT, +UMQTT, MQTT-SN introduction, +UMQTTSN, +UMQTTSNC, +ULWM2MADD, +ULWM2MREMOVE, +ULWM2MLIST, +ULWM2MCREATE, +ULWM2MDELETE, +ULWM2MWRITE, +ULWM2MREAD, +ULWM2MSTAT, +ULWM2M, +ULWM2MREG, +ULWM2MDEREG, +ULWM2MCONFIG, CME error result codes, Internet suite error classes, Ping error result codes, Multiple AT command interfaces, SARA-R422 Americas MNO profiles, SARA-R422 EMEA MNO profiles.</p> <p>Review the command applicability for these commands: +URATSCAN, &K, &V, +UPSD, +UBKUPDATA, +UPSMVER.</p> |

Contact

For complete contact information, visit us at www.u-blox.com.

u-blox Offices

North, Central and South America

u-blox America, Inc.
Phone: +1 703 483 3180
E-mail: info_us@u-blox.com

Regional Office West Coast:
Phone: +1 408 573 3640
E-mail: info_us@u-blox.com

Technical Support:
Phone: +1 703 483 3185
E-mail: support_us@u-blox.com

Headquarters

Europe, Middle East, Africa

u-blox AG
Phone: +41 44 722 74 44
E-mail: info@u-blox.com
Support: support@u-blox.com

Asia, Australia, Pacific

u-blox Singapore Pte. Ltd.
Phone: +65 6734 3811
E-mail: info_ap@u-blox.com
Support: support_ap@u-blox.com

Regional Office Australia:
Phone: +61 3 95667255
E-mail: info_anz@u-blox.com
Support: support_ap@u-blox.com

Regional Office China (Beijing):
Phone: +86 10 68 133 545
E-mail: info_cn@u-blox.com
Support: support_cn@u-blox.com

Regional Office China (Chongqing):
Phone: +86 23 6815 1588
E-mail: info_cn@u-blox.com
Support: support_cn@u-blox.com

Regional Office China (Shanghai):
Phone: +86 21 6090 4832
E-mail: info_cn@u-blox.com
Support: support_cn@u-blox.com

Regional Office China (Shenzhen):
Phone: +86 755 8627 1083
E-mail: info_cn@u-blox.com
Support: support_cn@u-blox.com

Regional Office India:
Phone: +91 80 4050 9200
E-mail: info_in@u-blox.com
Support: support_in@u-blox.com

Regional Office Japan (Osaka):
Phone: +81 6 6941 3660
E-mail: info_jp@u-blox.com
Support: support_jp@u-blox.com

Regional Office Japan (Tokyo):
Phone: +81 3 5775 3850
E-mail: info_jp@u-blox.com
Support: support_jp@u-blox.com

Regional Office Korea:
Phone: +82 2 542 0861
E-mail: info_kr@u-blox.com
Support: support_kr@u-blox.com

Regional Office Taiwan:
Phone: +886 2 2657 1090
E-mail: info_tw@u-blox.com
Support: support_tw@u-blox.com